

SECTIONAL VIEW

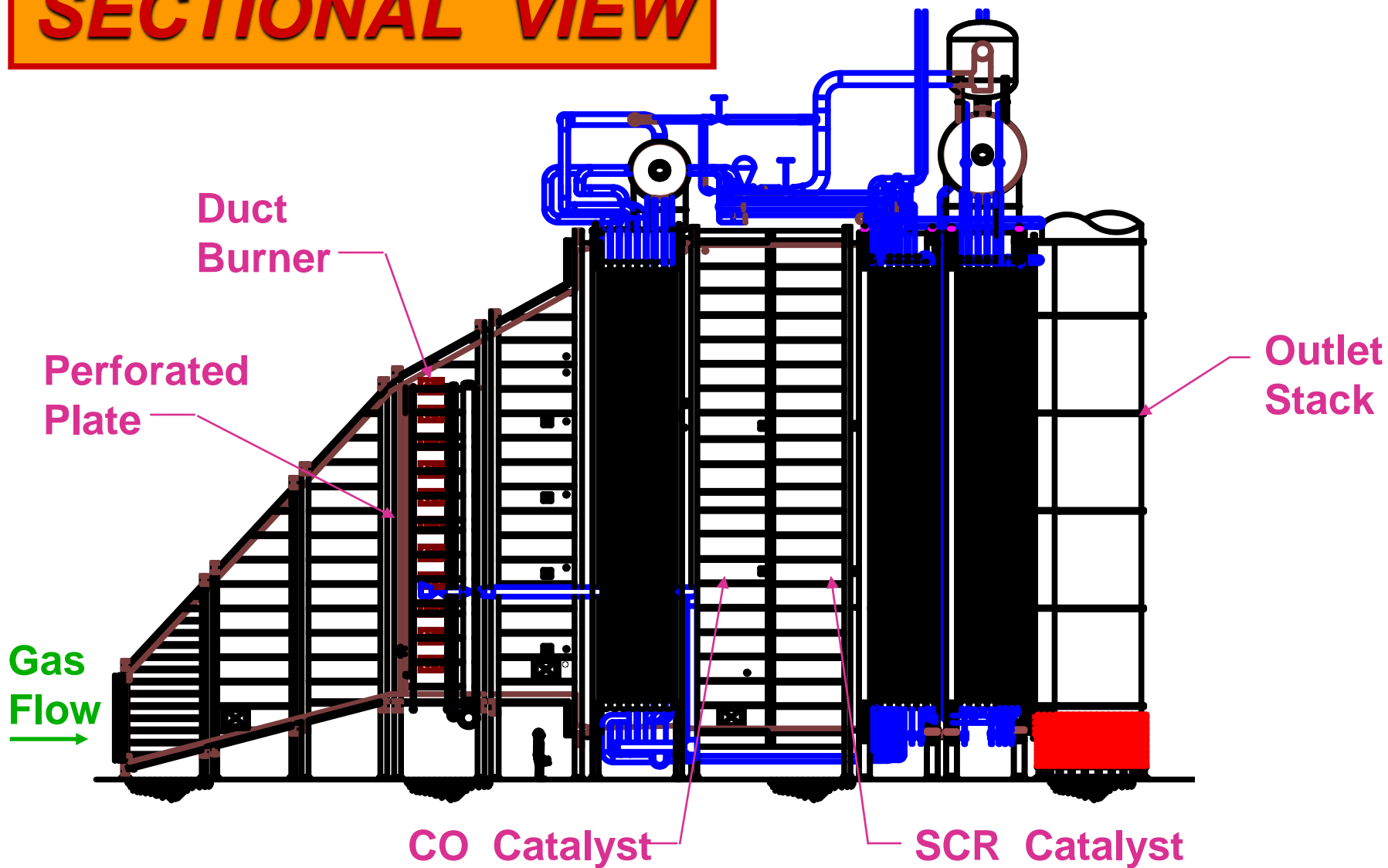

Typical Catalyst Operation Window

SCR Catalysts Operating Window

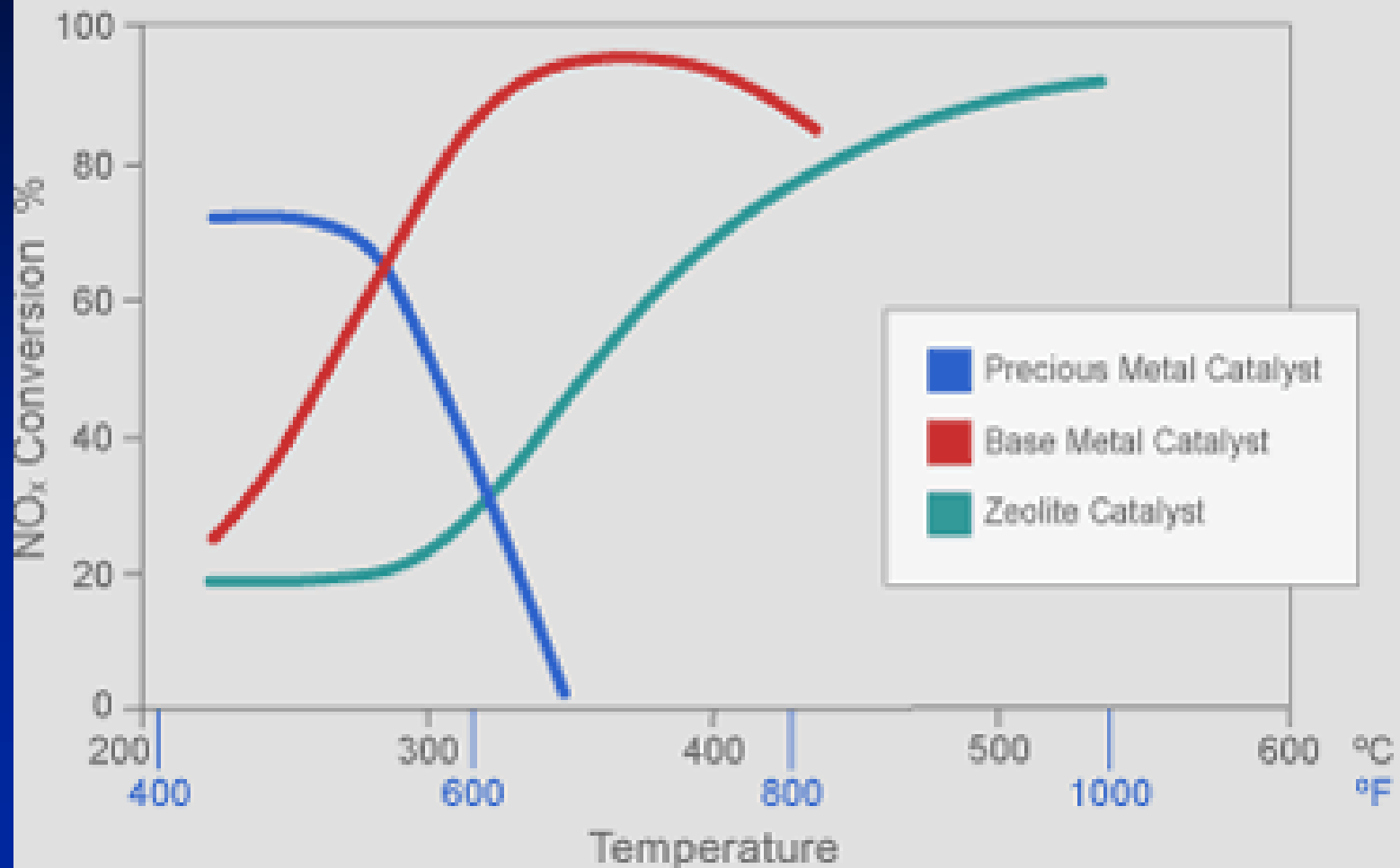

Boiler with SNCR

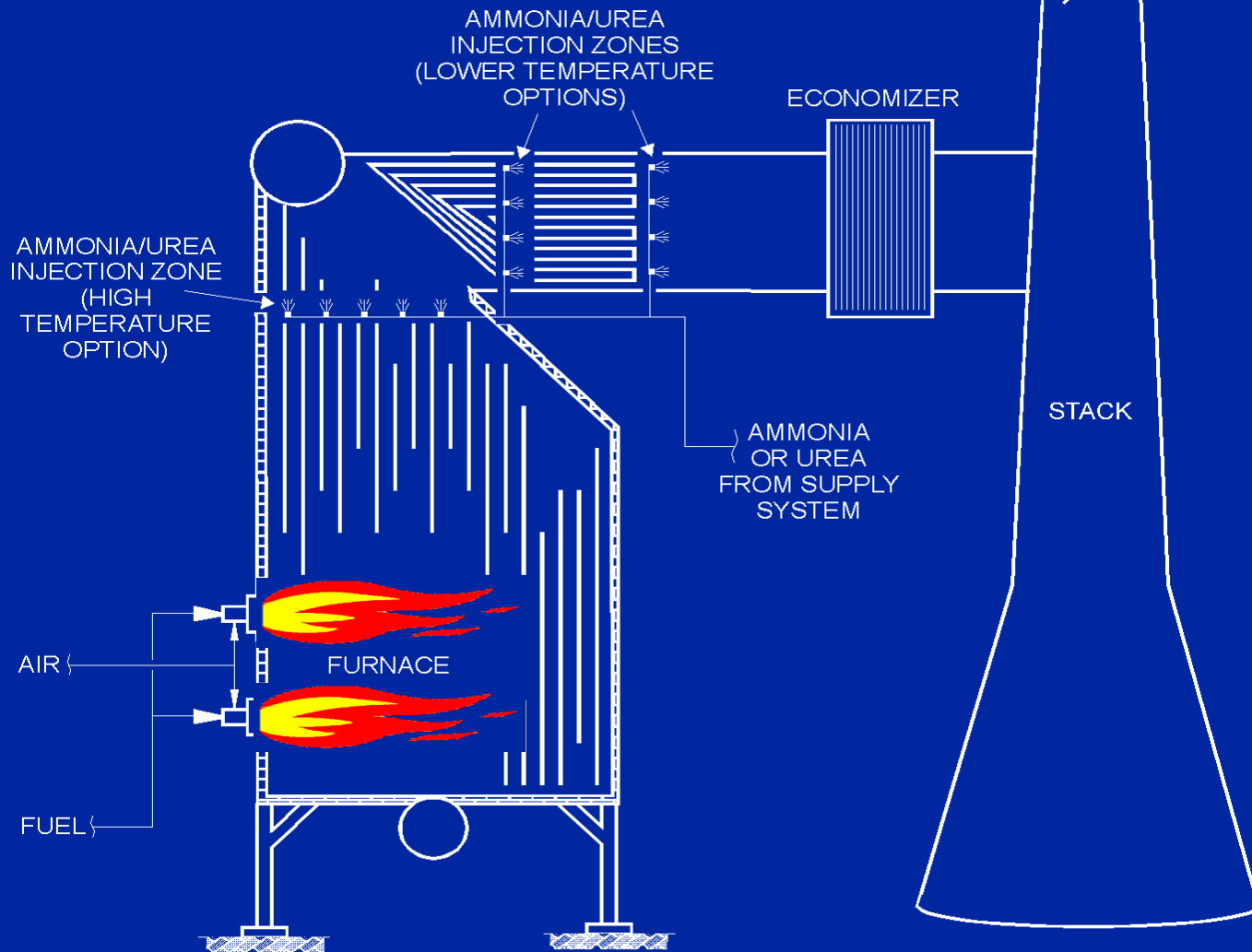

Selective Non-Catalytic Reduction

Ammonia

NH₃



N₂

Urea

NH₂CONH₂



NH₃ + HNCO



N₂O



SCR vs. SNCR

	SNCR	SCR
NOx Reductiuon	20-50%	50-95%
Hardware	Simple	More Complex
Capital Cost	Low (1)	High (5-10)
Reagent Utilization	Typ. 30%	Almost 100%
O&M	Reagent	Reagent/Catalyst
Designability	Poor	Good
NH3 slip	5-20 ppm	<10 ppm

Typical packed scrubber

Liquor flow and pH monitoring

Recirculation liquid pumping system and liquor make-up

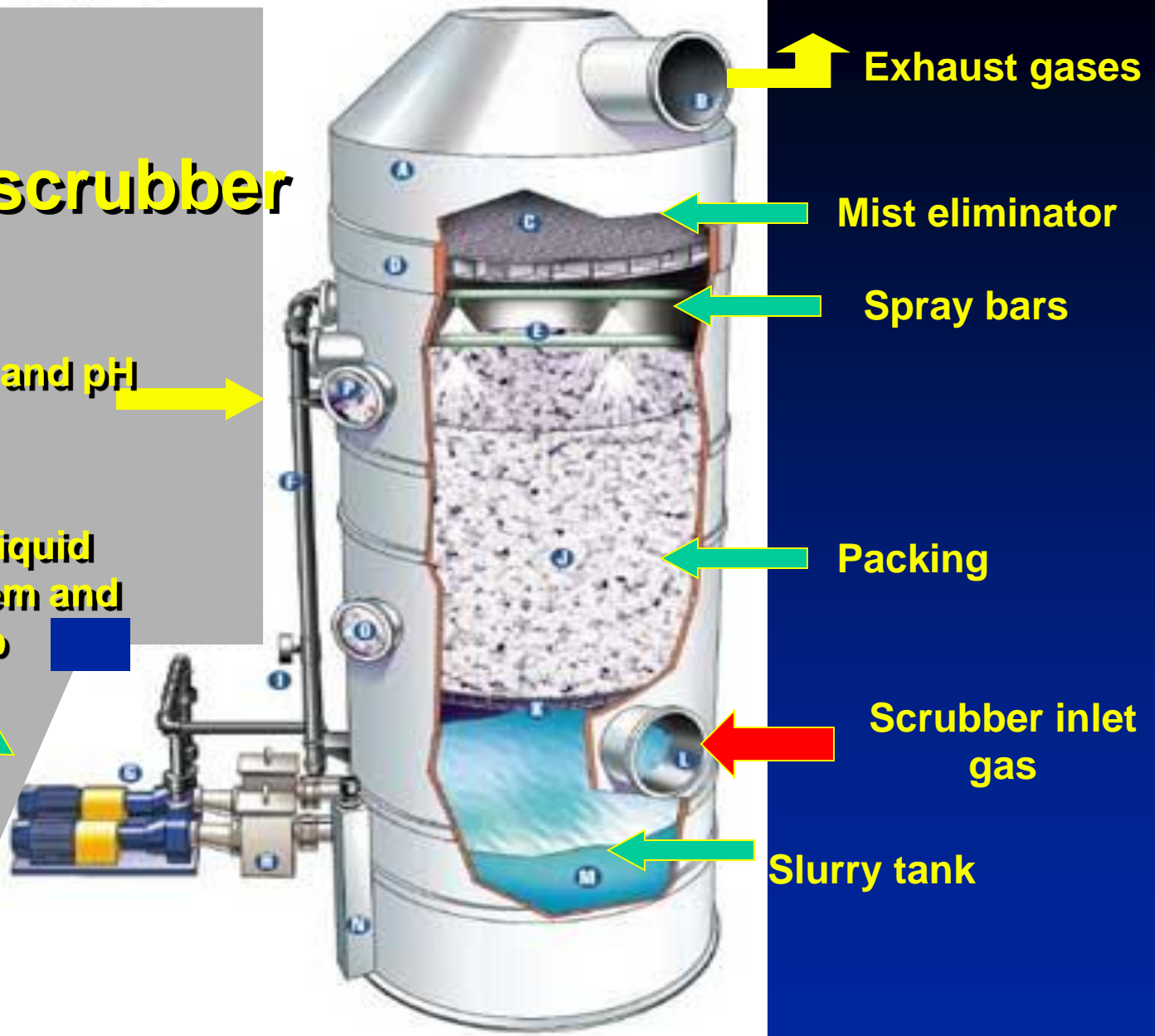

SO_x Control

Wet FGD

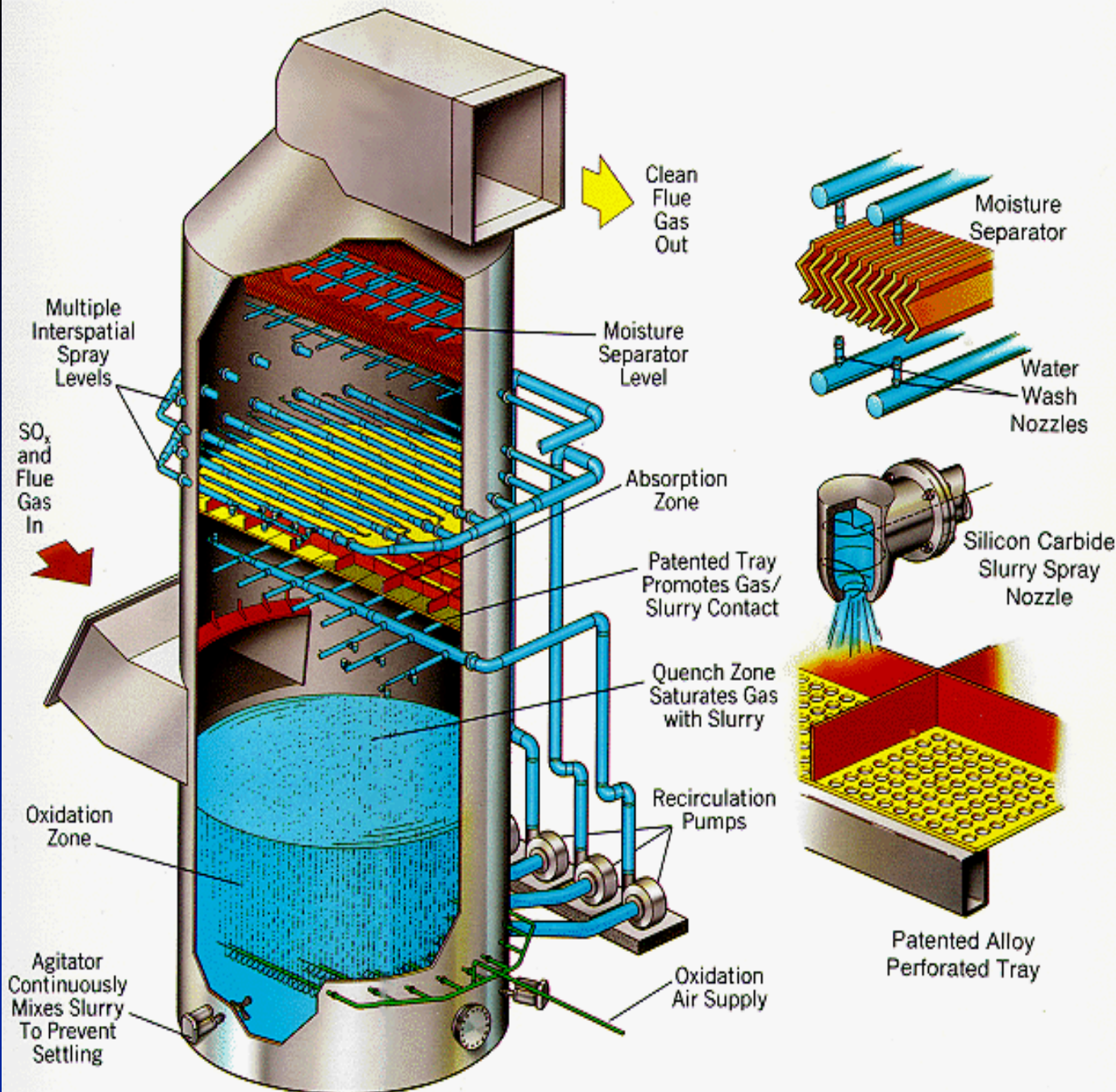

Carbon Adsorber – Fixed Bed Schematic

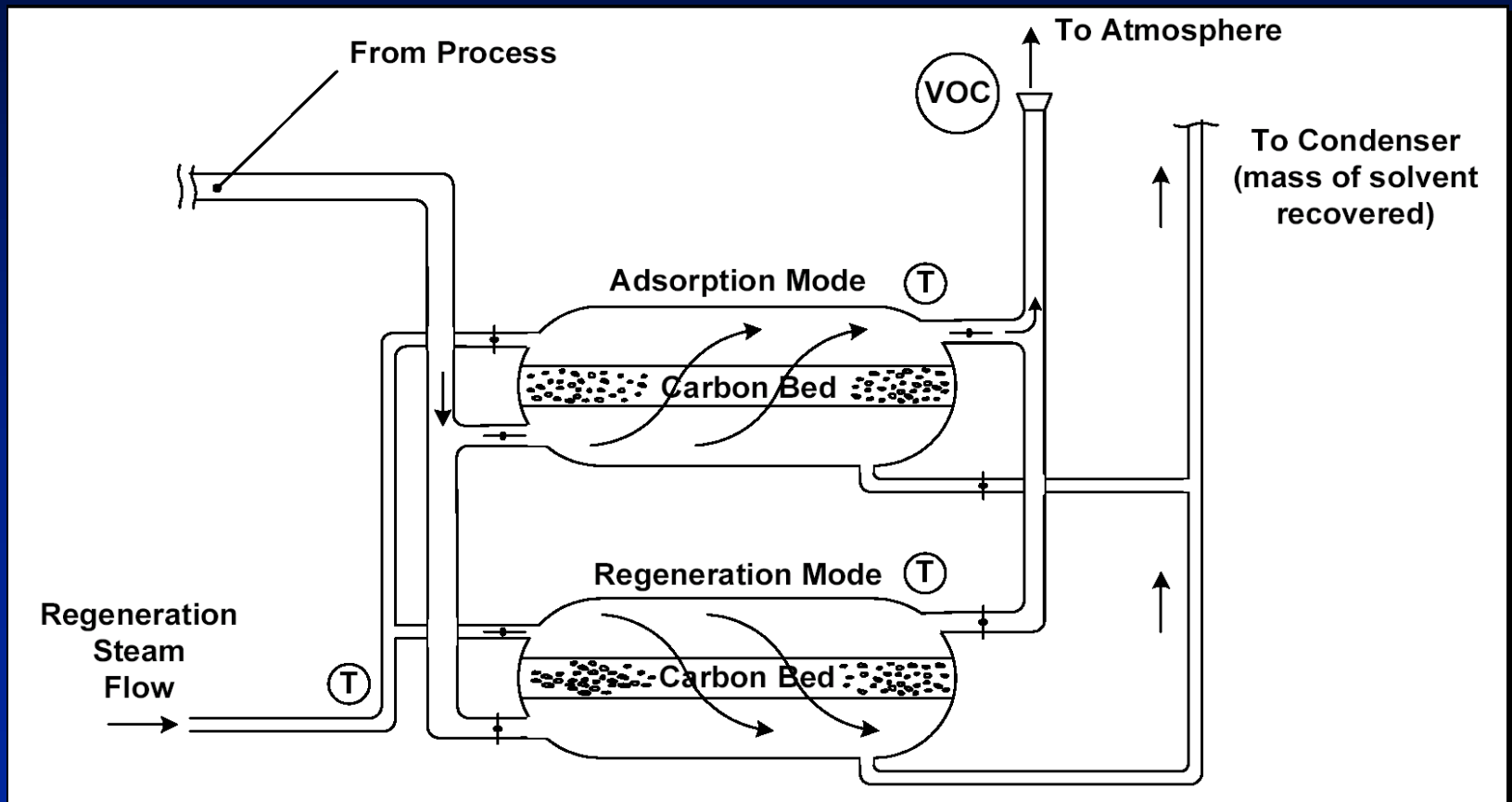

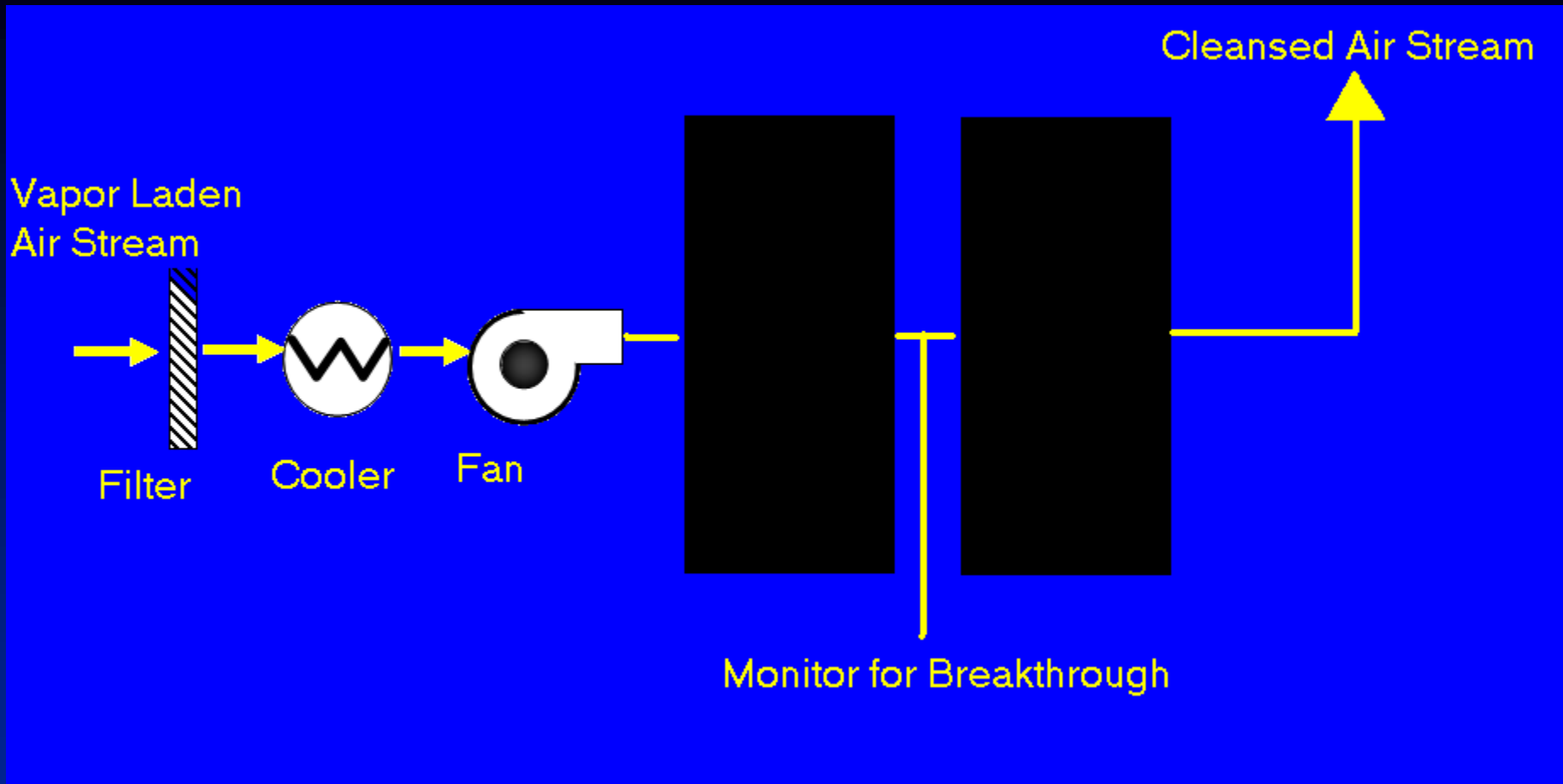

Carbon Adsorption System

Thermal Oxidizer - Schematic

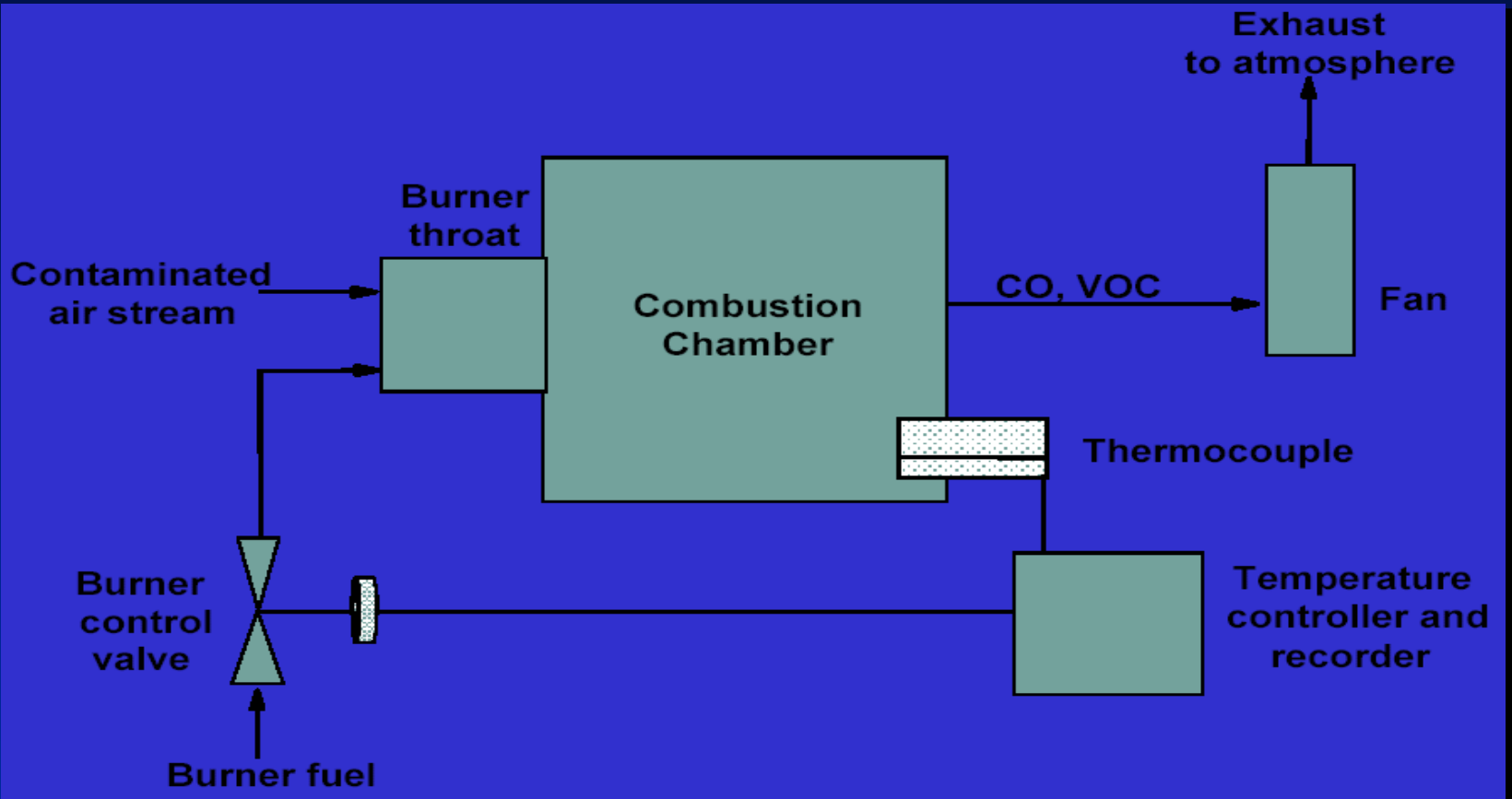

Catalytic Oxidizer/Incinerator

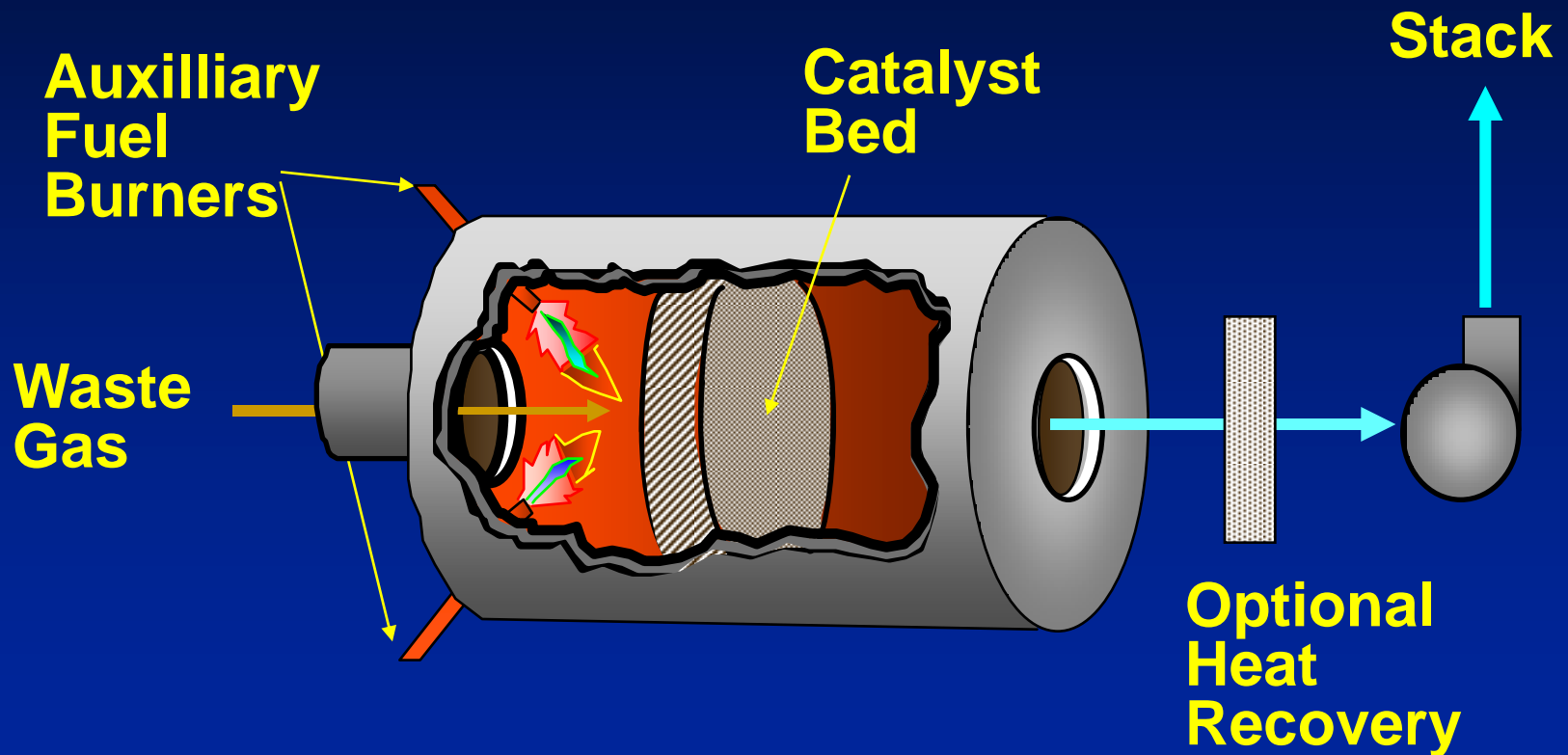

Catalytic Oxidizer Incinerator Schematic

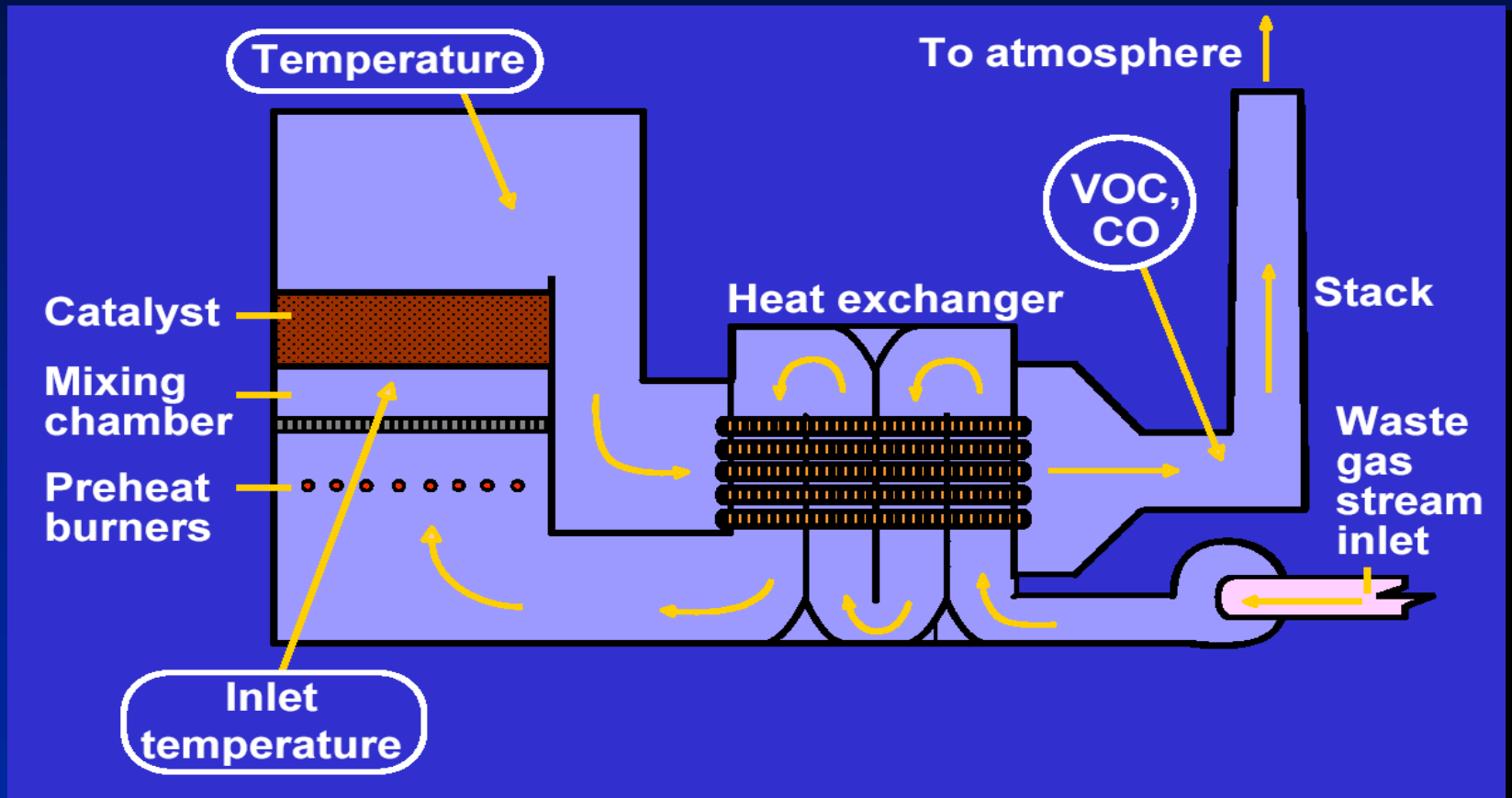

Recuperative TO

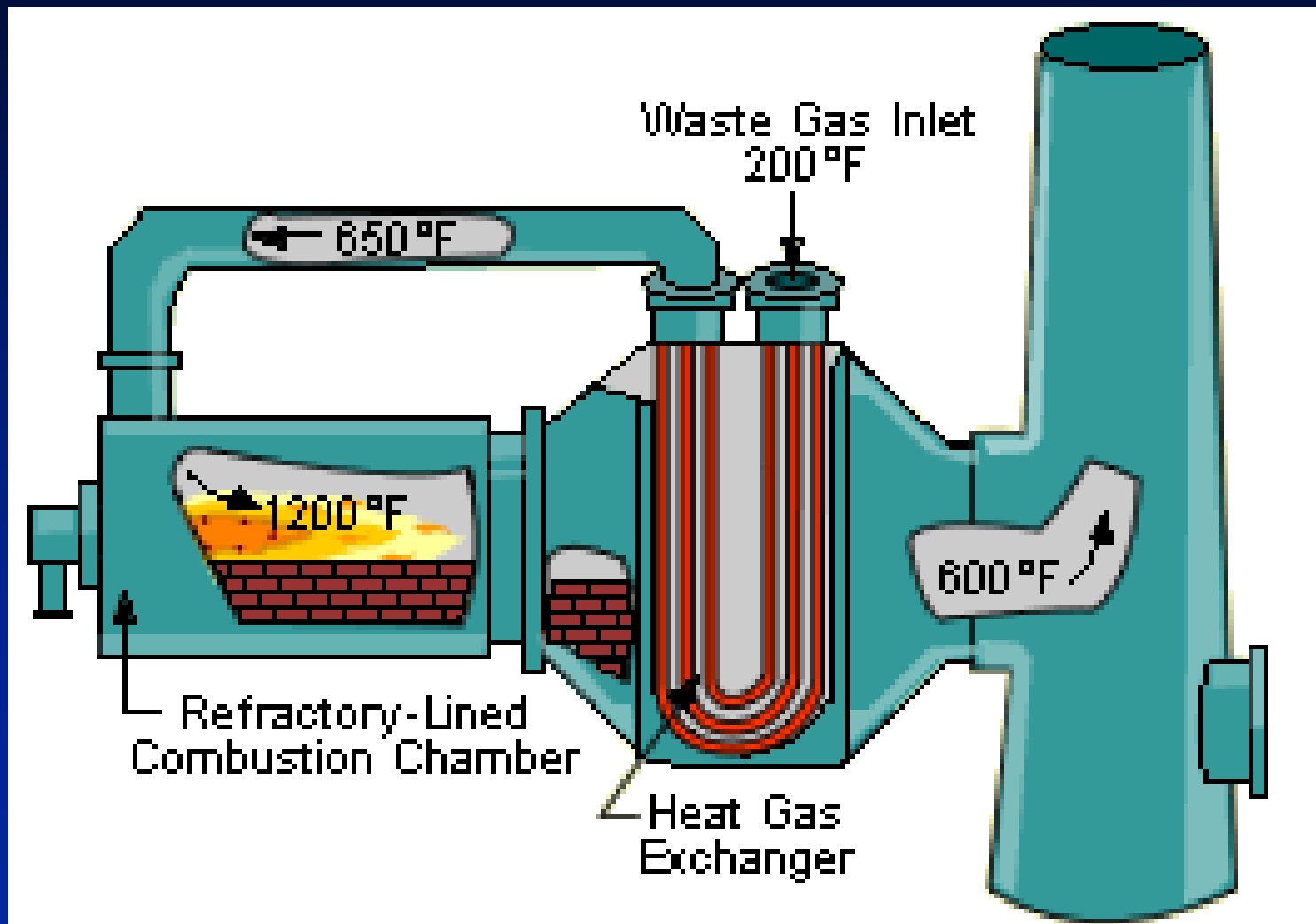

Catalytic Recuperative

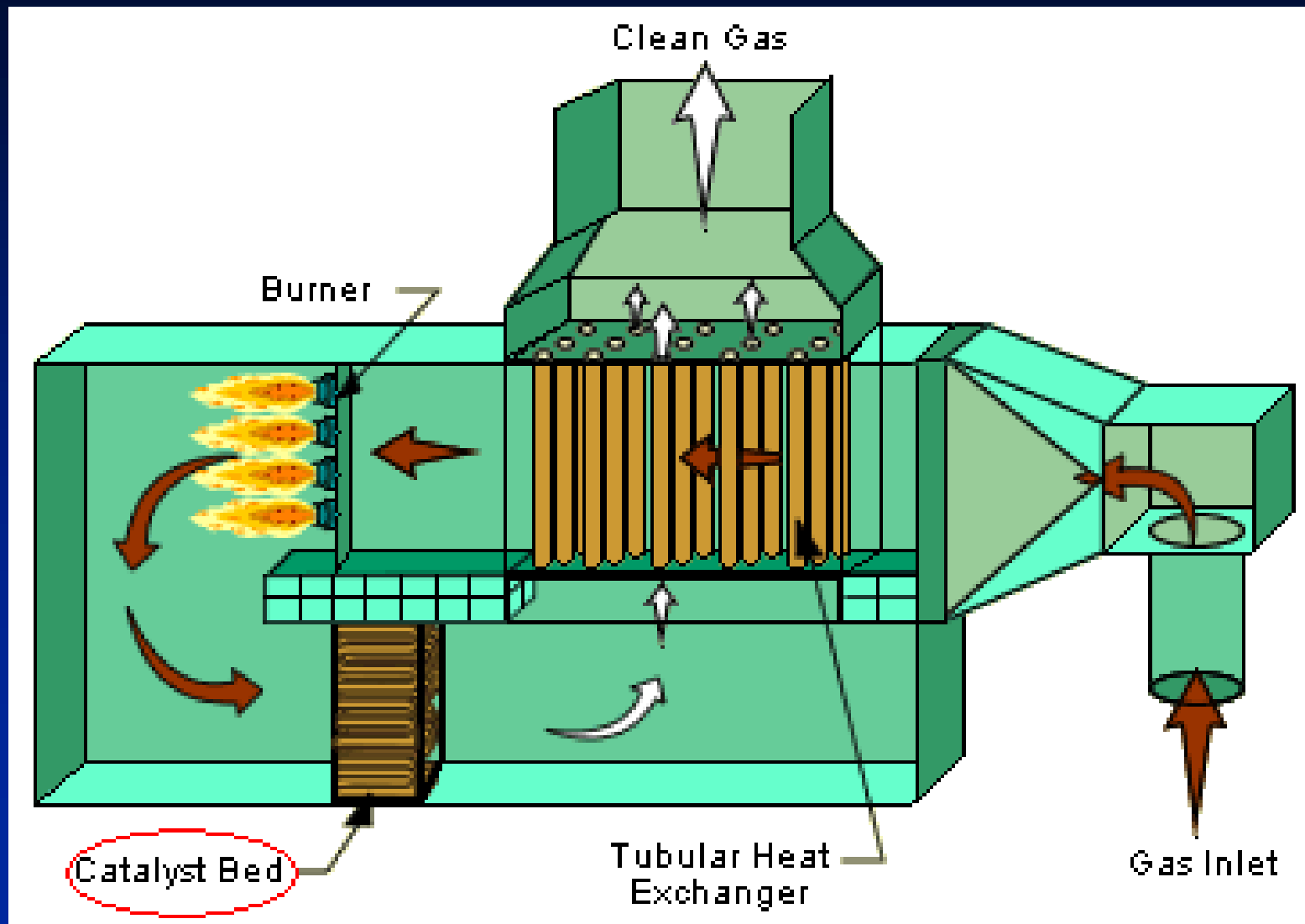

Regenerative TO

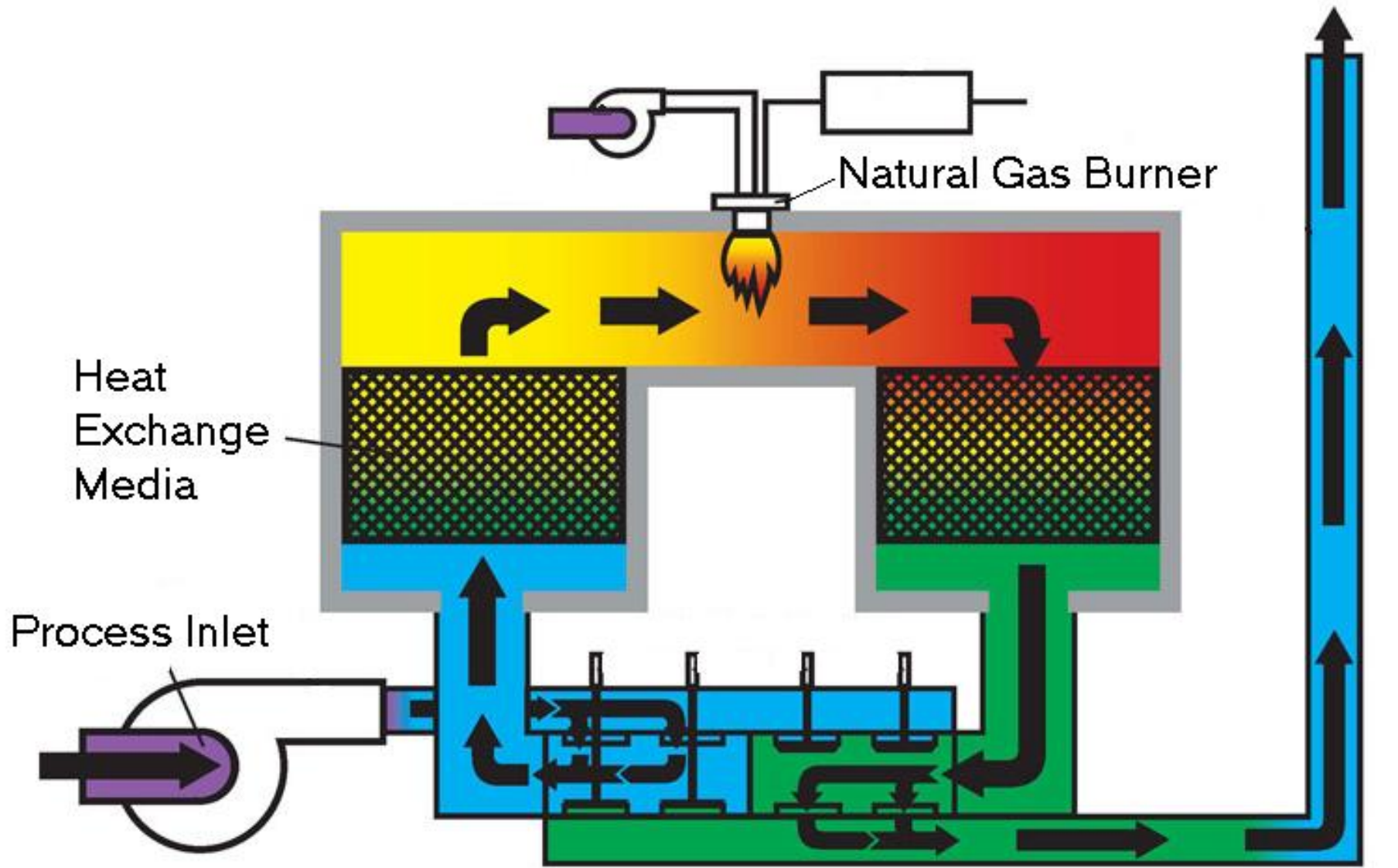

RTO Operation

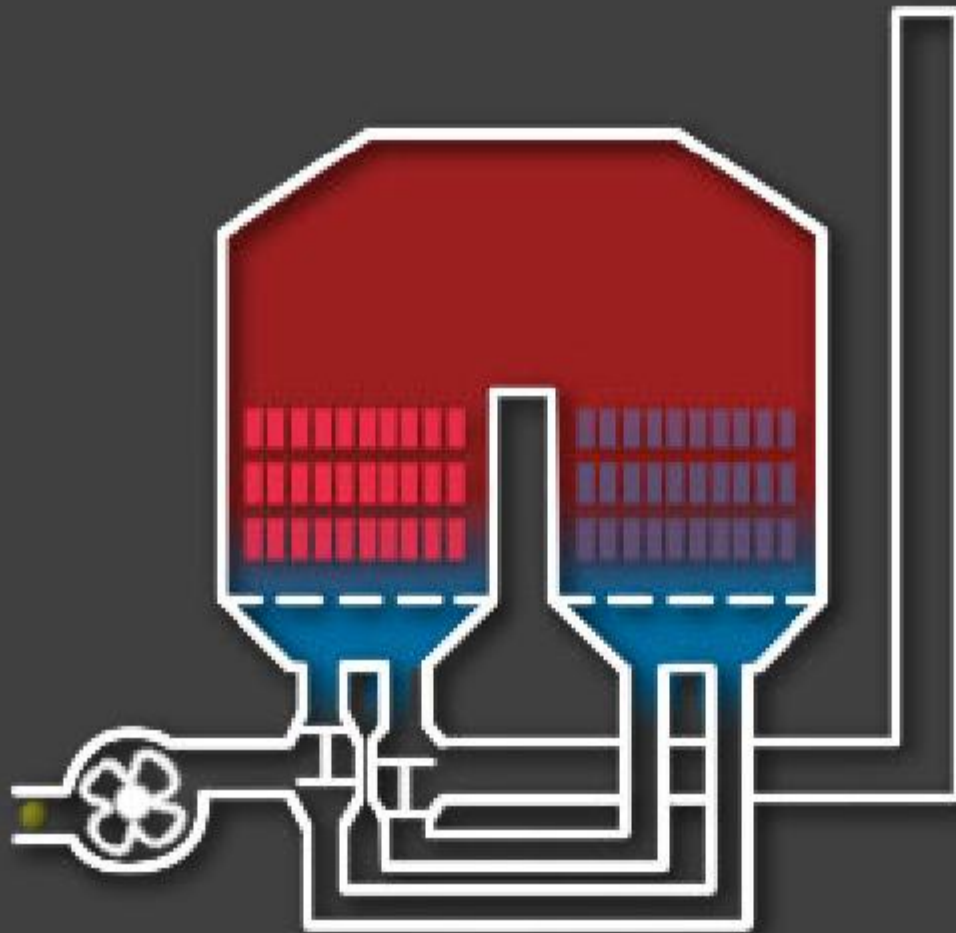

PM Control Techniques - Cyclone

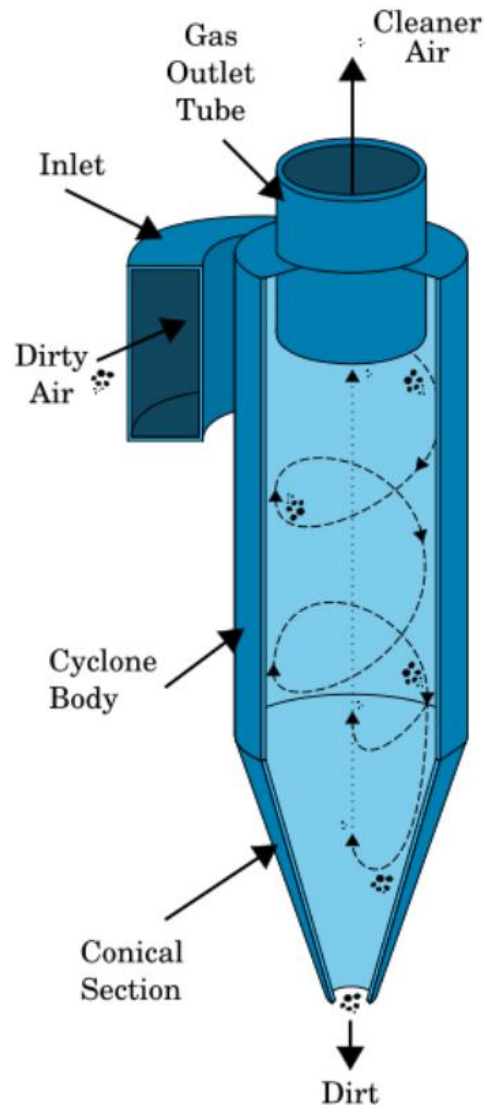

How a Cyclone Works

Baghouse Cleaning Methods

Mechanical Shaker

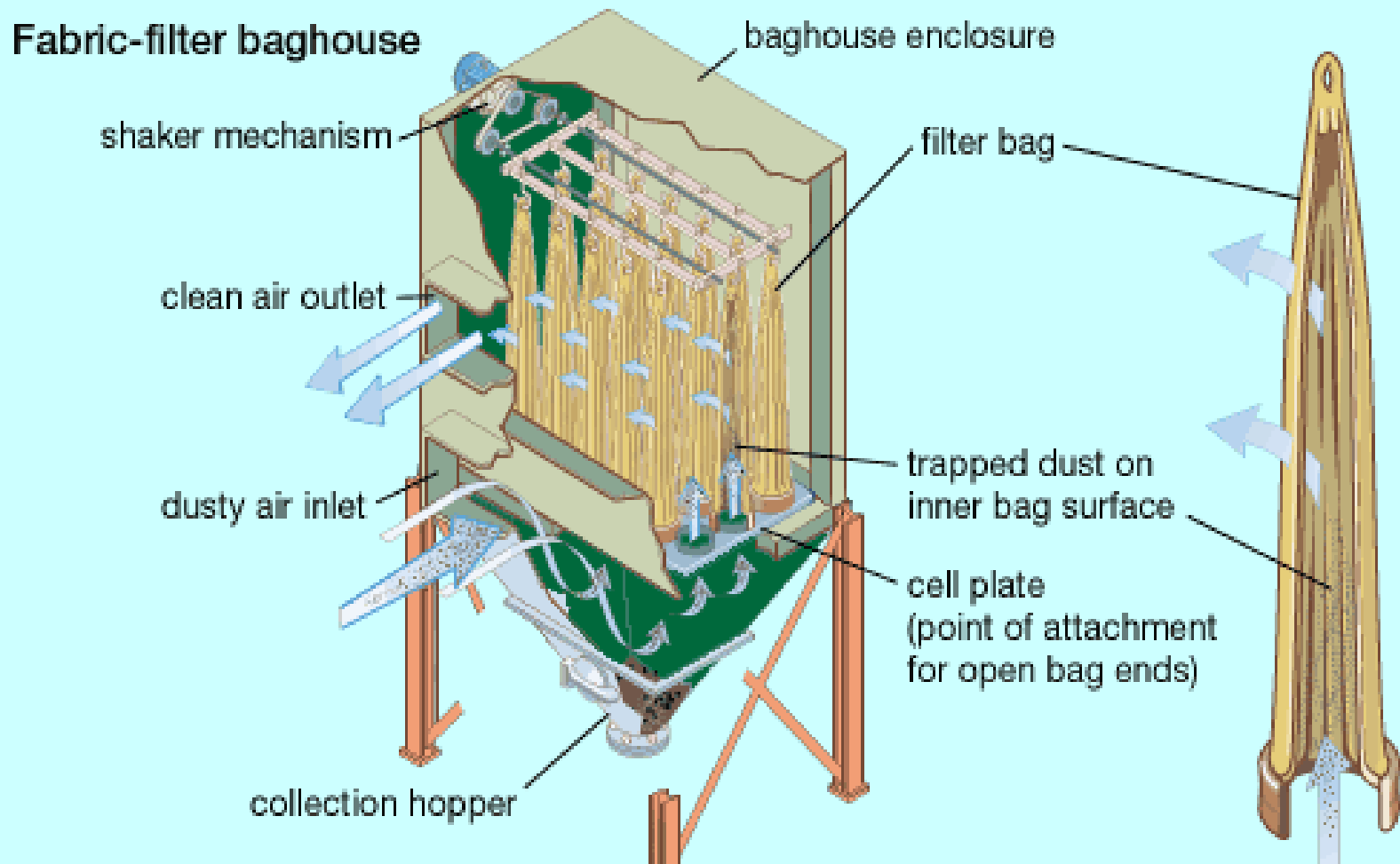

Baghouse Cleaning Methods

Reverse Air

SINGLE BAG SCHEMATIC

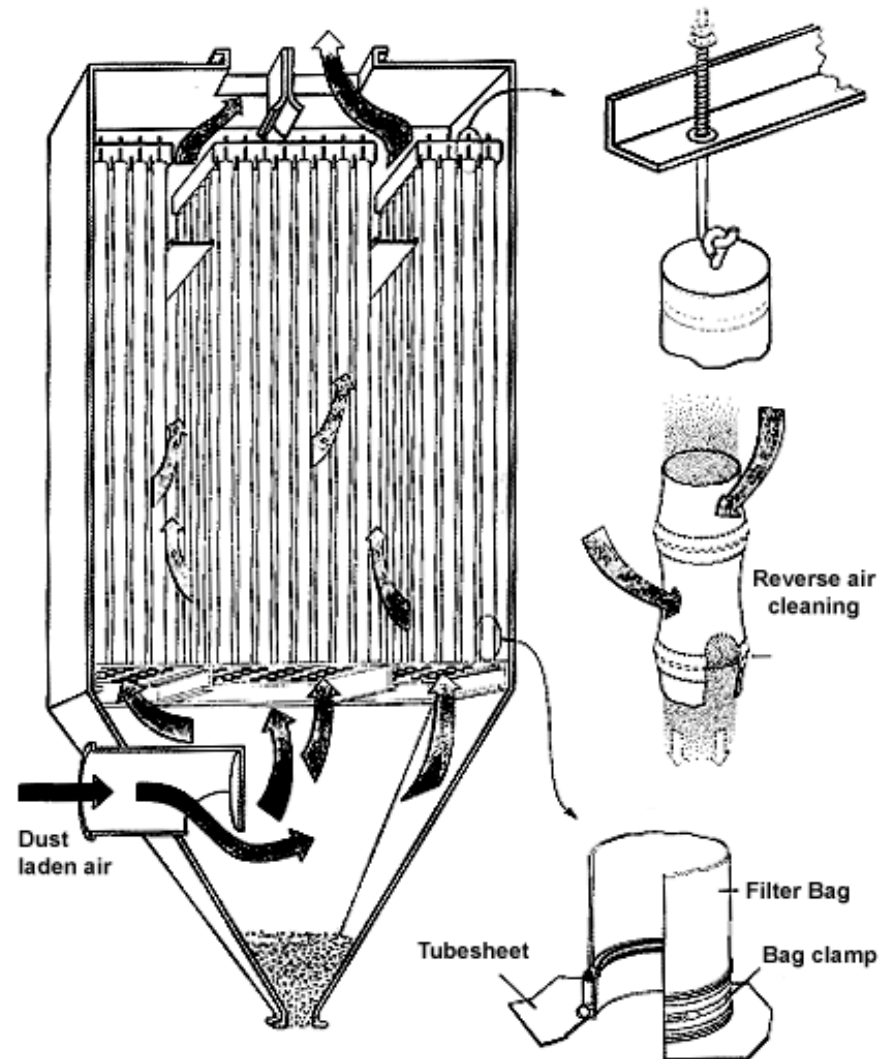
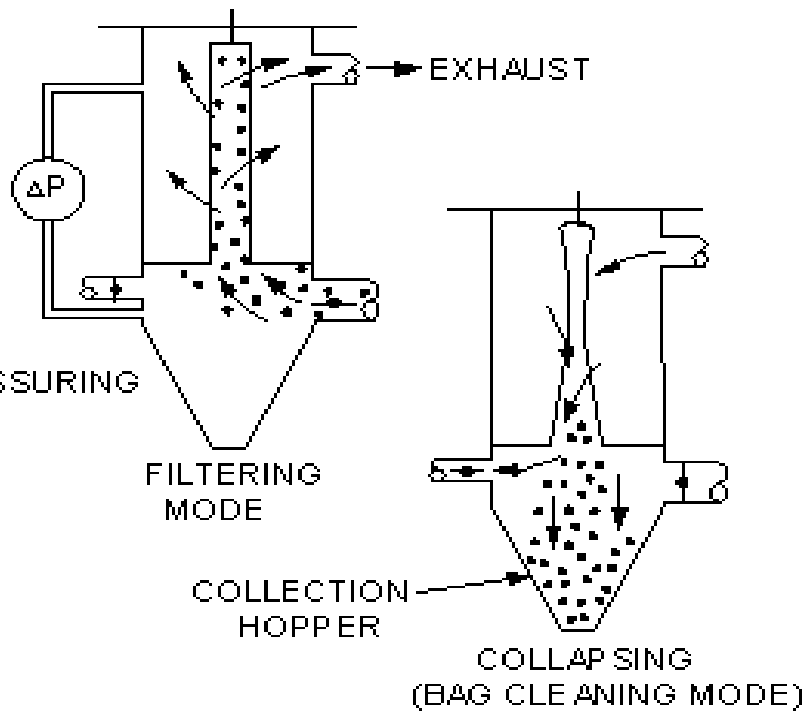

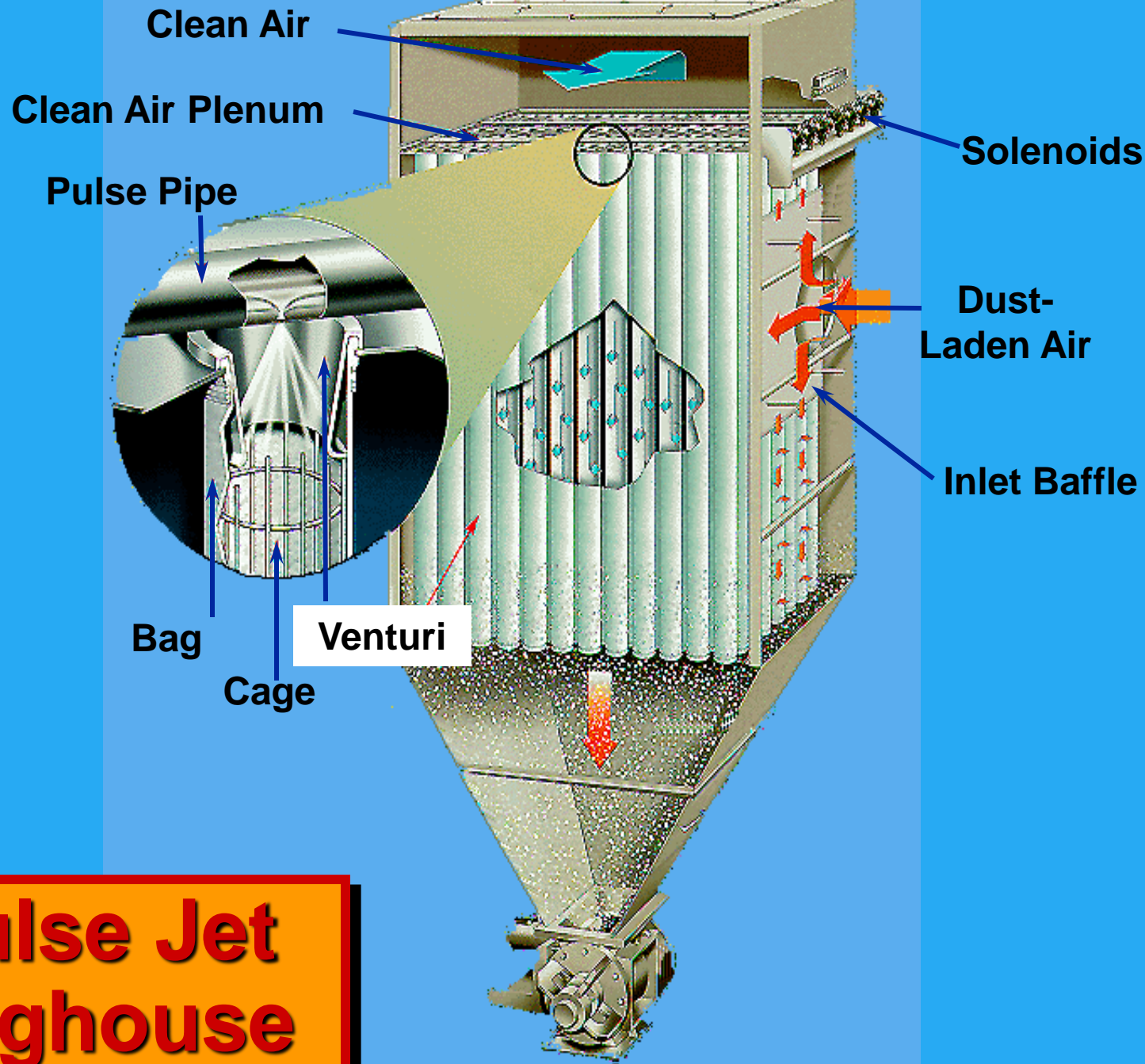

Pulse Jet Baghouse

Electrostatic Precipitator

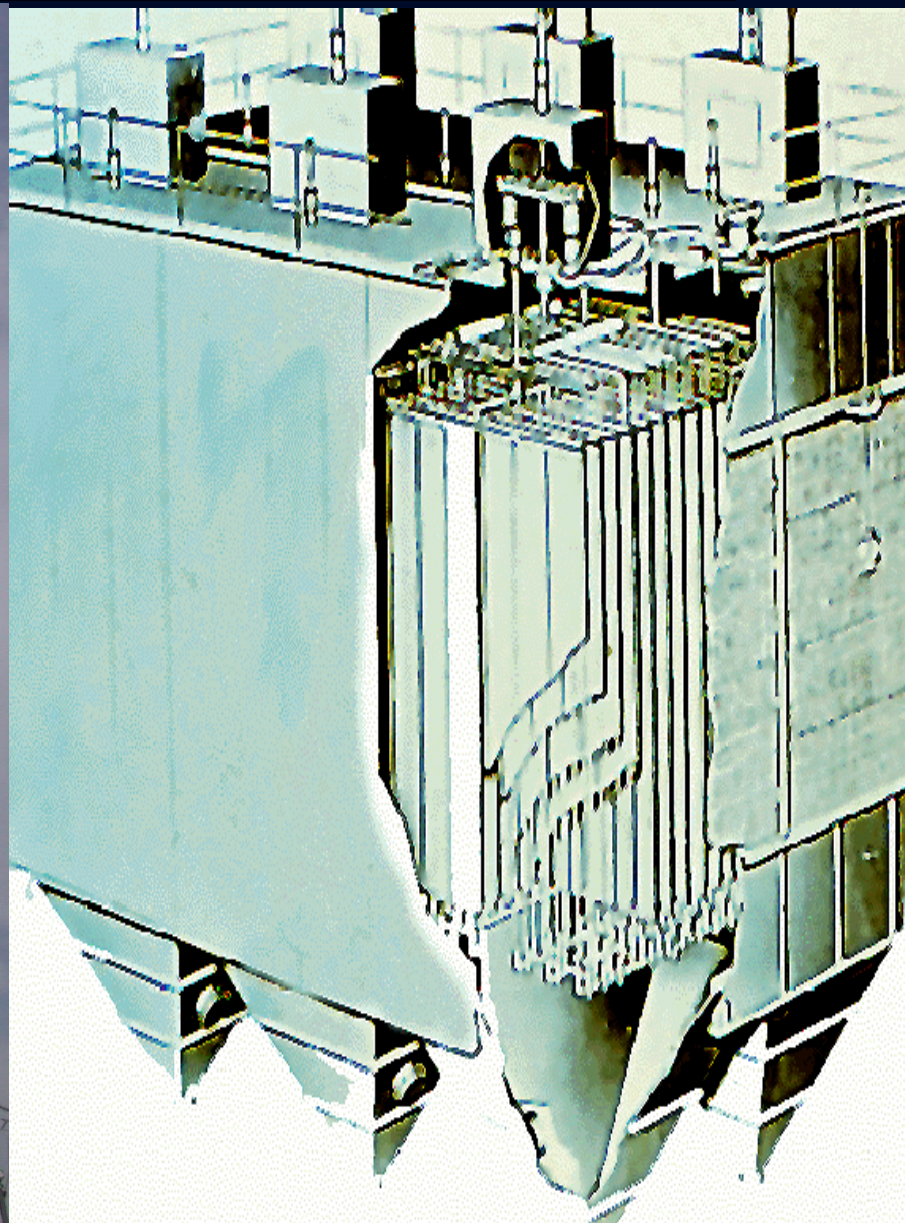

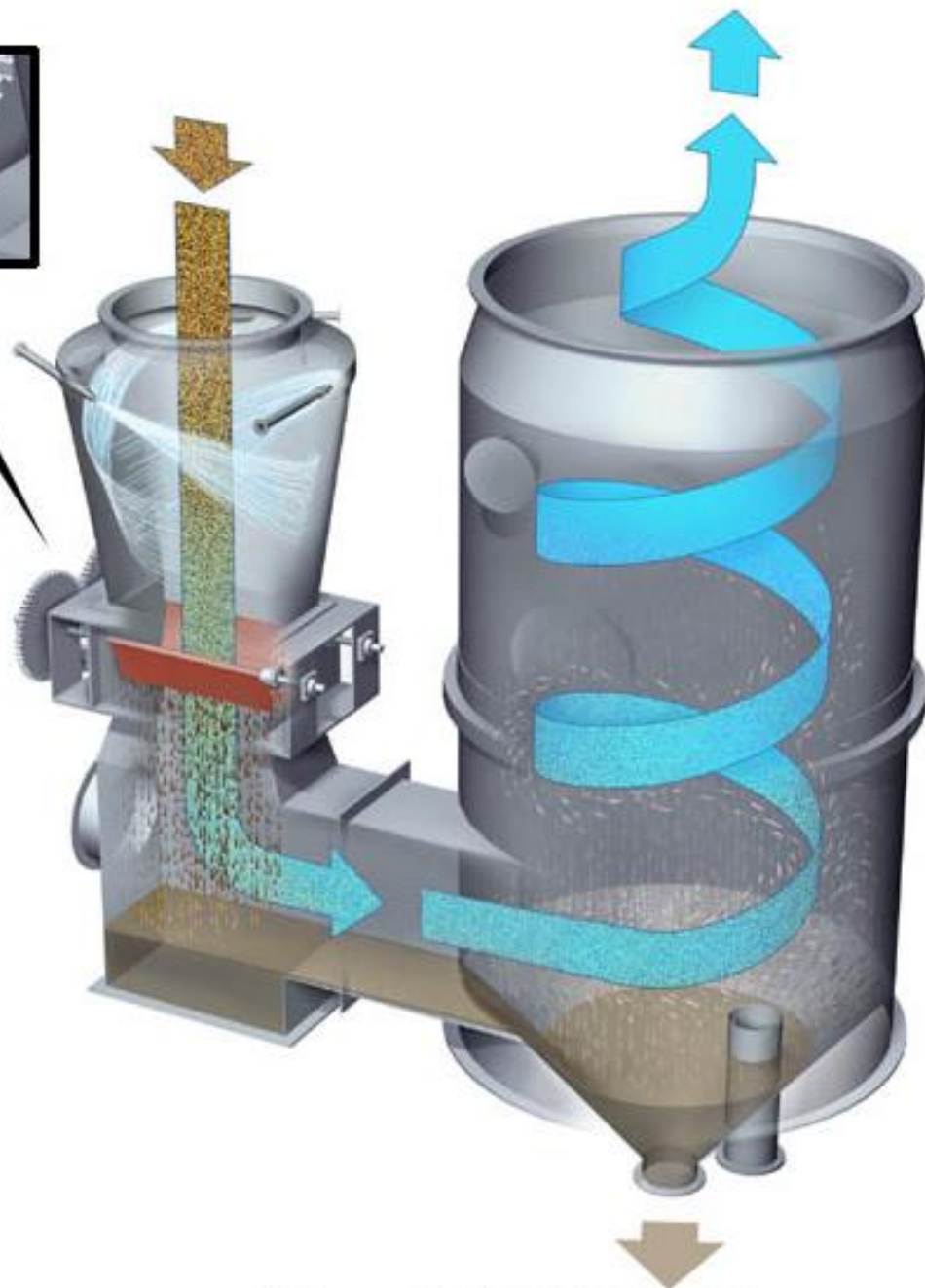

Venturi Scrubber

What is a DPF

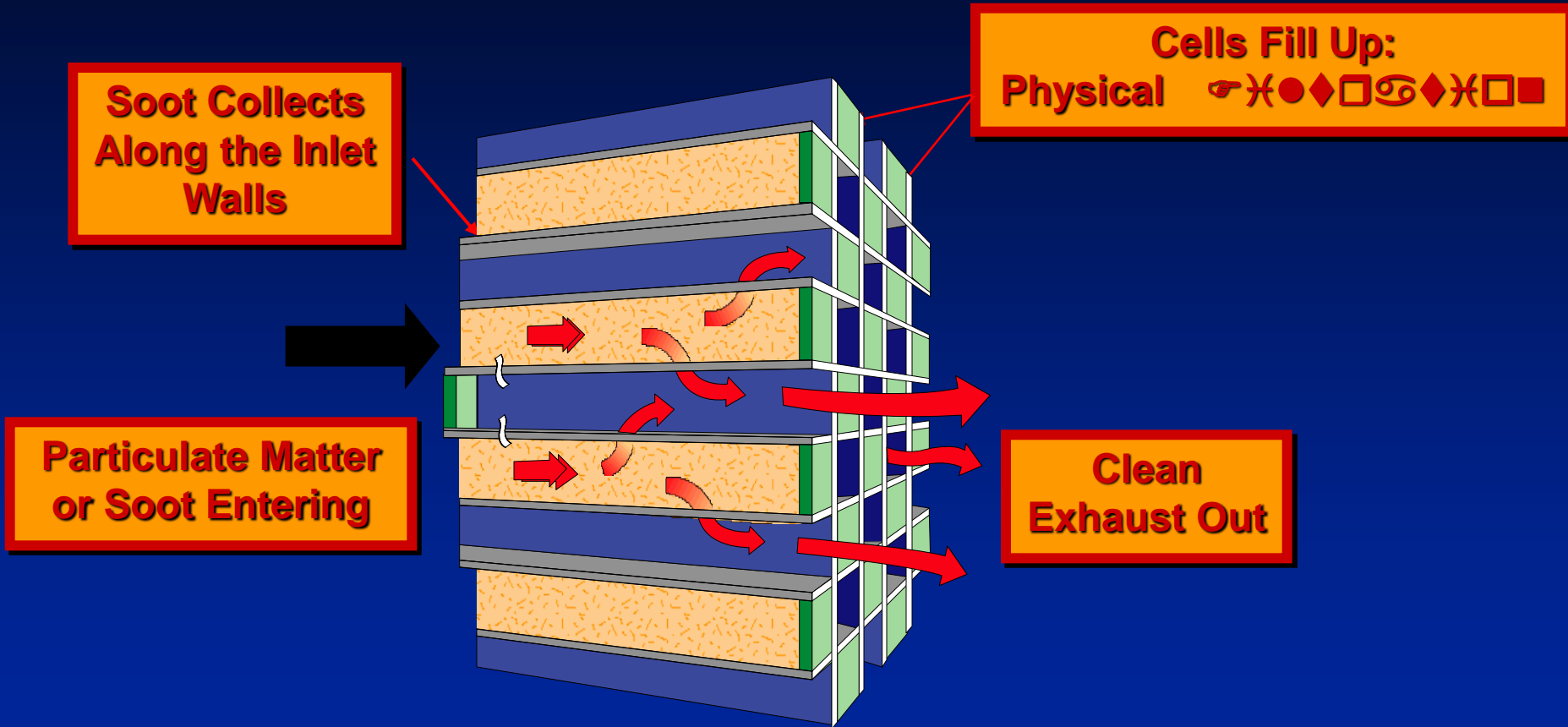

control unit



exhaust backpressure

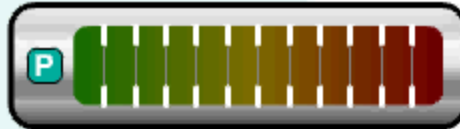

operating hours

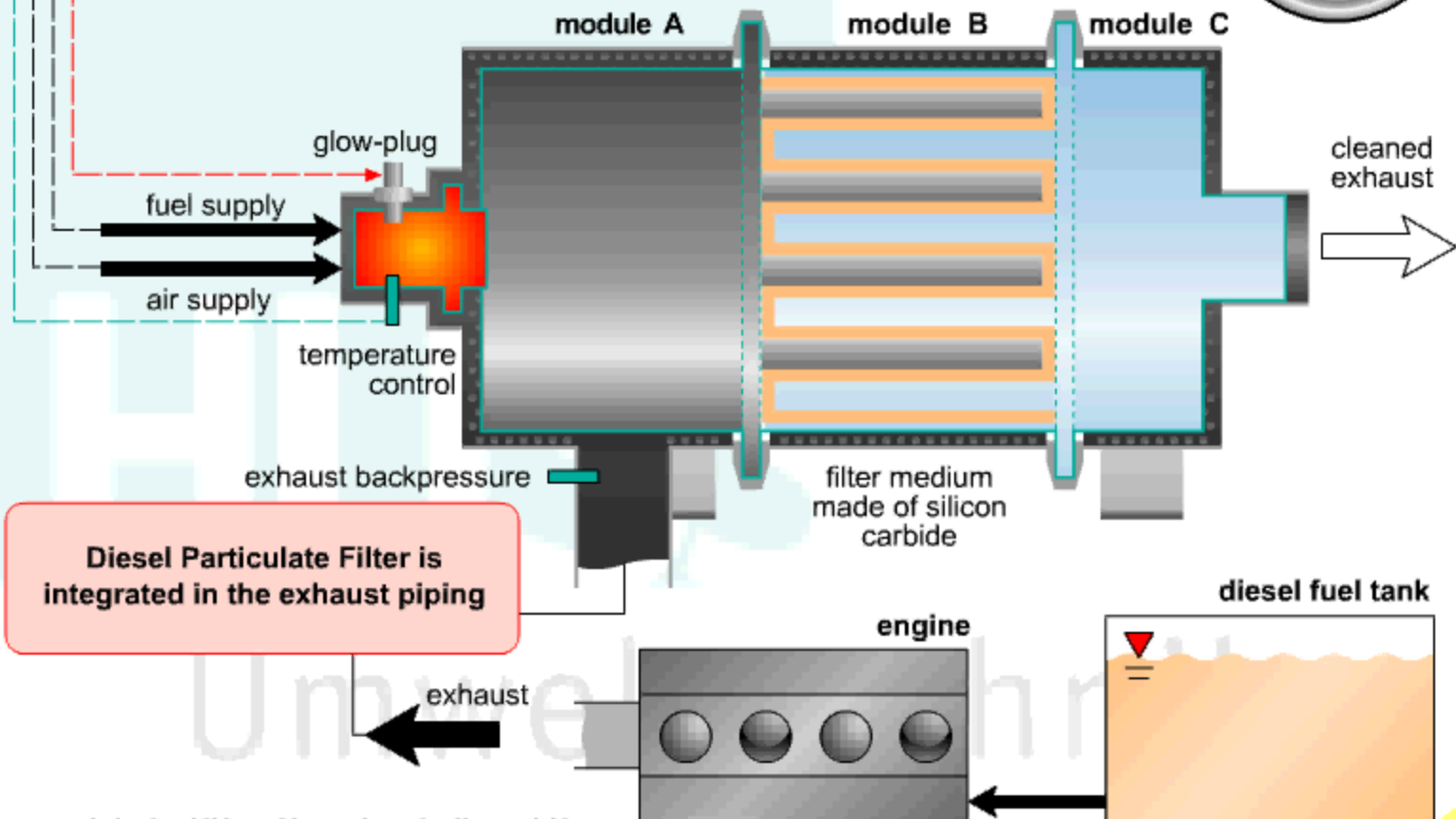

Copyright by HUSS-Umwelttechnik GmbH