

# Chapter 1

## Introduction to Atmospheric Sampling



---

### APTI 435: Atmospheric Sampling Course





# Terminal Learning Objective

- At the end of this chapter, the student will be able to explain the purpose of atmospheric sampling and describe a typical sampling train design.

# Enabling Learning Objectives

- 1.1 - Explain the purpose of atmospheric sampling.
- 1.2 - Describe a typical sampling train design.

# Introduction

## Purpose of Atmospheric Sampling

- Evaluate the success of Air Pollution Programs.
- To determine compliance with the National Ambient Air Quality Standards (NAAQS)



# Sampling Train Design



## Typical Sampling Train

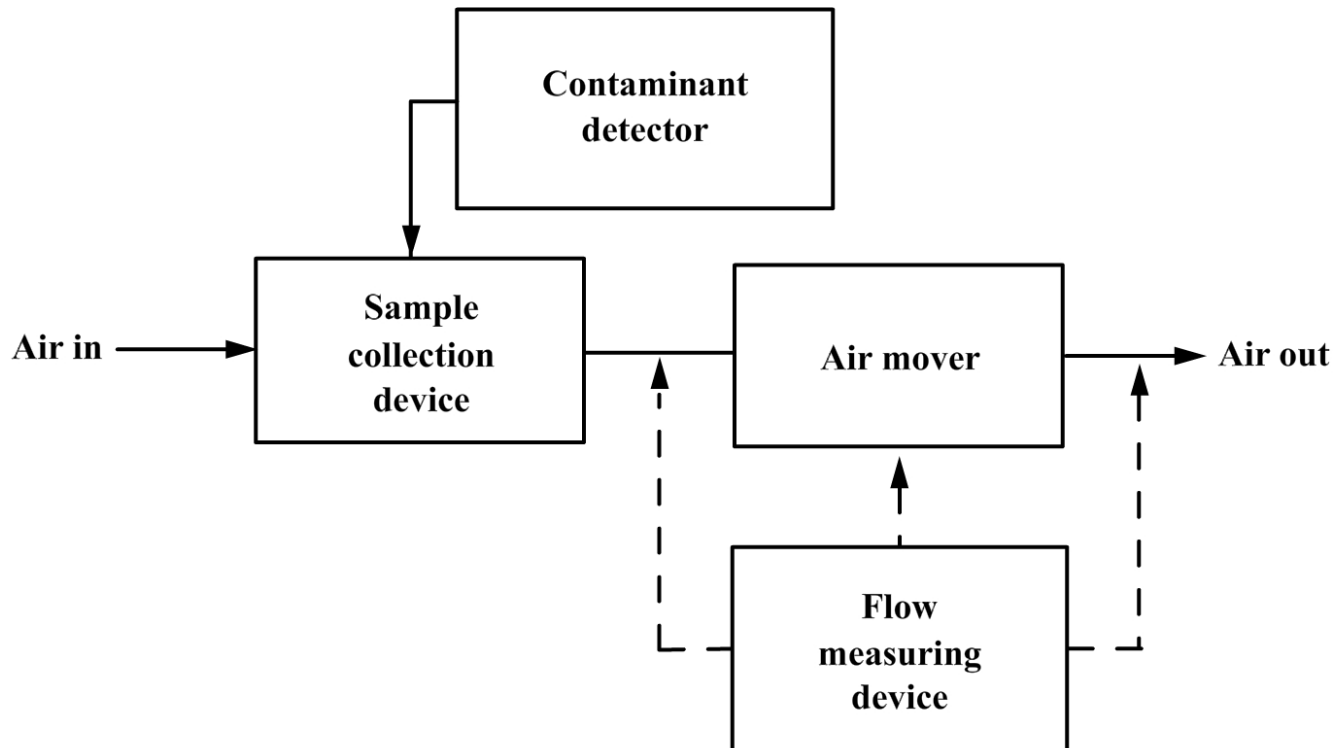

# Sampling Train Design

## Sampling Methods

- Wet chemical methods
- “Whole air” sampling methods
- Instrumental methods

## Sampling Devices

- Containers made of stainless steel, glass, or pliable plastics
- Pre-evacuated passivated canister
- Air movers
- Ejectors
- Evacuated flasks
- Rotameters
- Mass flow meters
- Mass flow controllers
- Critical and subcritical orifices



# Sampling Train Design

## Sampling Materials

- Glass
- Teflon®
- Stainless Steel



# APTI 435: Atmospheric Sampling Course Chapter 1



Questions?



Summary



# Chapter 2

## Basic Gas Properties and Mathematical Manipulations



---

APTI 435: Atmospheric Sampling Course





# Terminal Learning Objective

- At the end of this chapter, the student will be able to identify basic gas properties and mathematical manipulations.



# Enabling Learning Objectives

- 2.1- Differentiate between temperature scales and absolute temperature.
- 2.2- Identify the types of pressure and the instruments used.
- 2.3- Identify the ideal gas laws.
- 2.4- Describe gas density.
- 2.5- Define the term *Reynolds Number*.
- 2.6- Explain equations used to identify basic gas properties.
- 2.7- Identify units of measurements that measure air pollution parameters.
- 2.8- Describe use of references and definitions.

# Temperature

## The Fahrenheit and Celsius Scales



(Eq. 2-1)

$$^{\circ}\text{F} = 1.8^{\circ}\text{C} + 32$$

(Eq. 2-2)

$$^{\circ}\text{C} = \frac{(^{\circ}\text{F} - 32)}{1.8}$$

$^{\circ}\text{F}$  = degrees Fahrenheit

$^{\circ}\text{C}$  = degrees Celsius

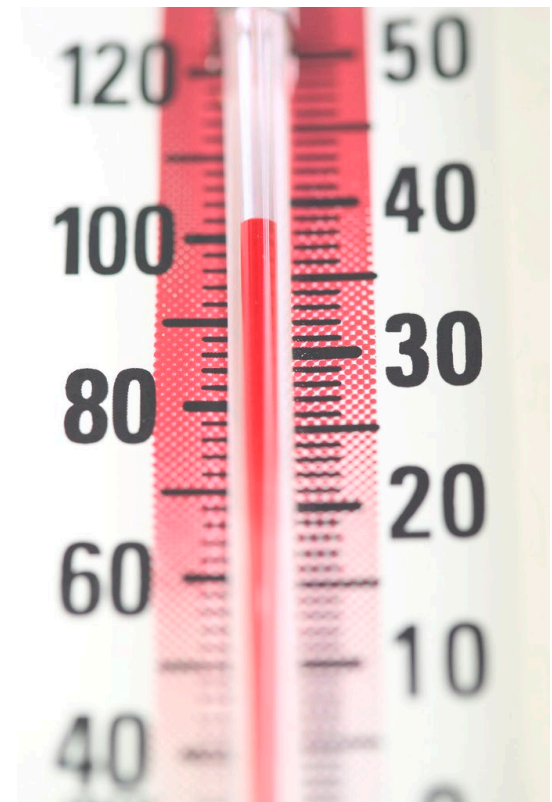

# Temperature

## Absolute Temperature

Eq. 2-3  $K = ^\circ C + 273.16$

Eq. 2-4  $^{\circ}R = ^\circ F + 459.67$

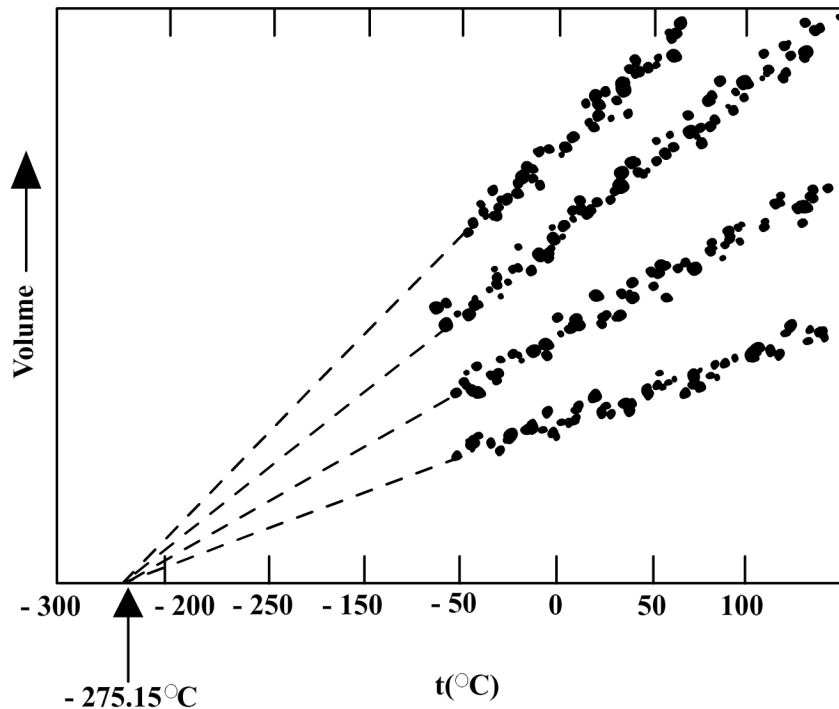

Temperature relationships

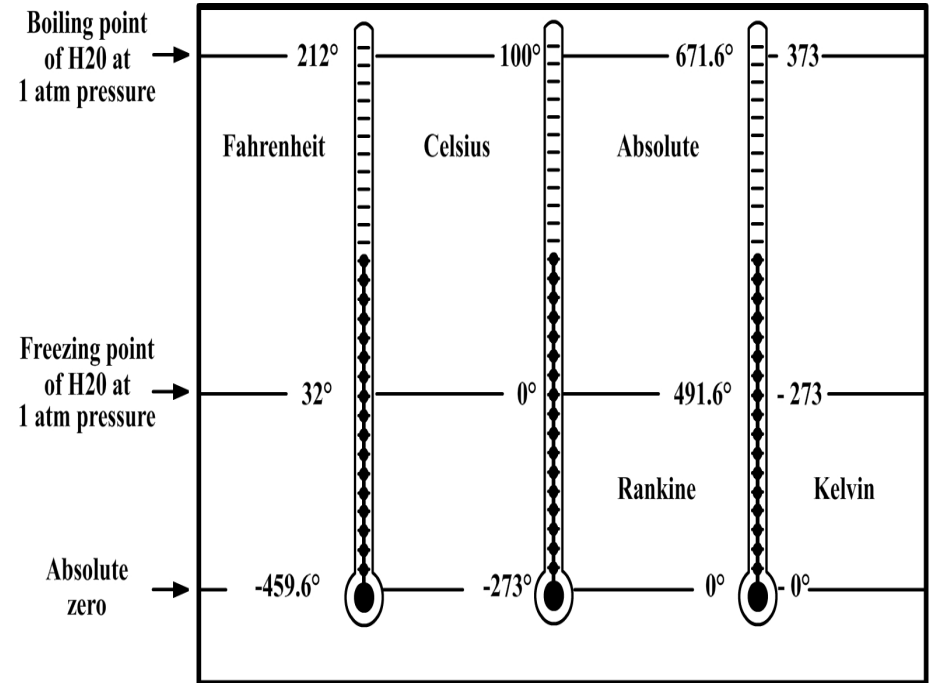

Relationships of the absolute temperature systems

# Pressure

## Definition of Pressure

- Unit compressive stress in a fluid is termed *pressure* and is expressed as *force per unit area*

Metric	English
$\text{gm}_f / \text{cm}^2$	$\text{lb}_f / \text{in}^2$ (psi)

## Barometric Pressure

- Atmospheric pressure varied by weather and altitude



# Pressure

## Torricelli (Mercurial) Barometer

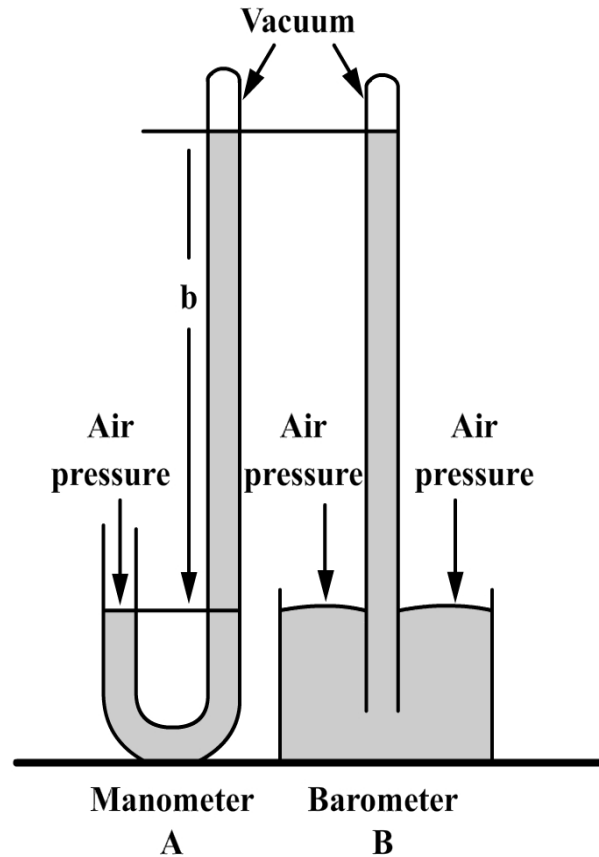

Manometer and Mercurial Barometer

# Pressure

## Fortin Barometer

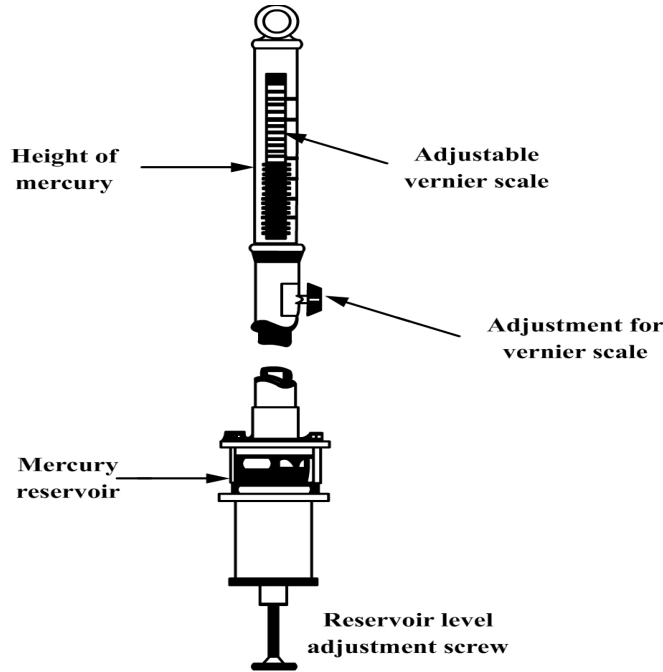

Fortin barometer

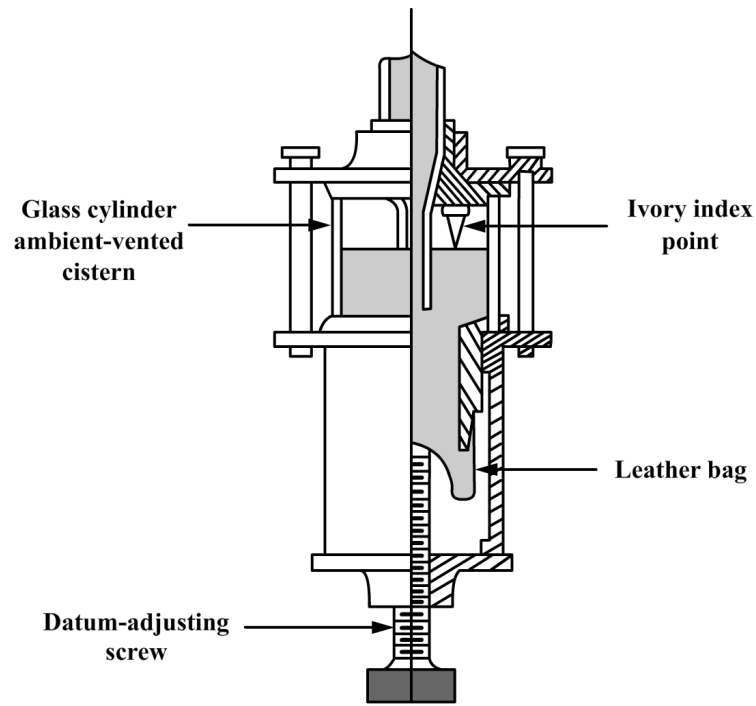

Blow-up of Fortin barometer

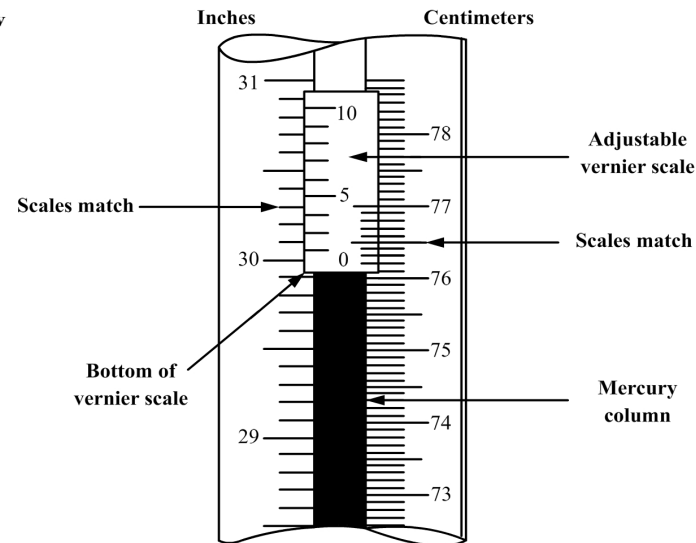

Blow-up of vernier scale



# Pressure

## Aneroid Barometer

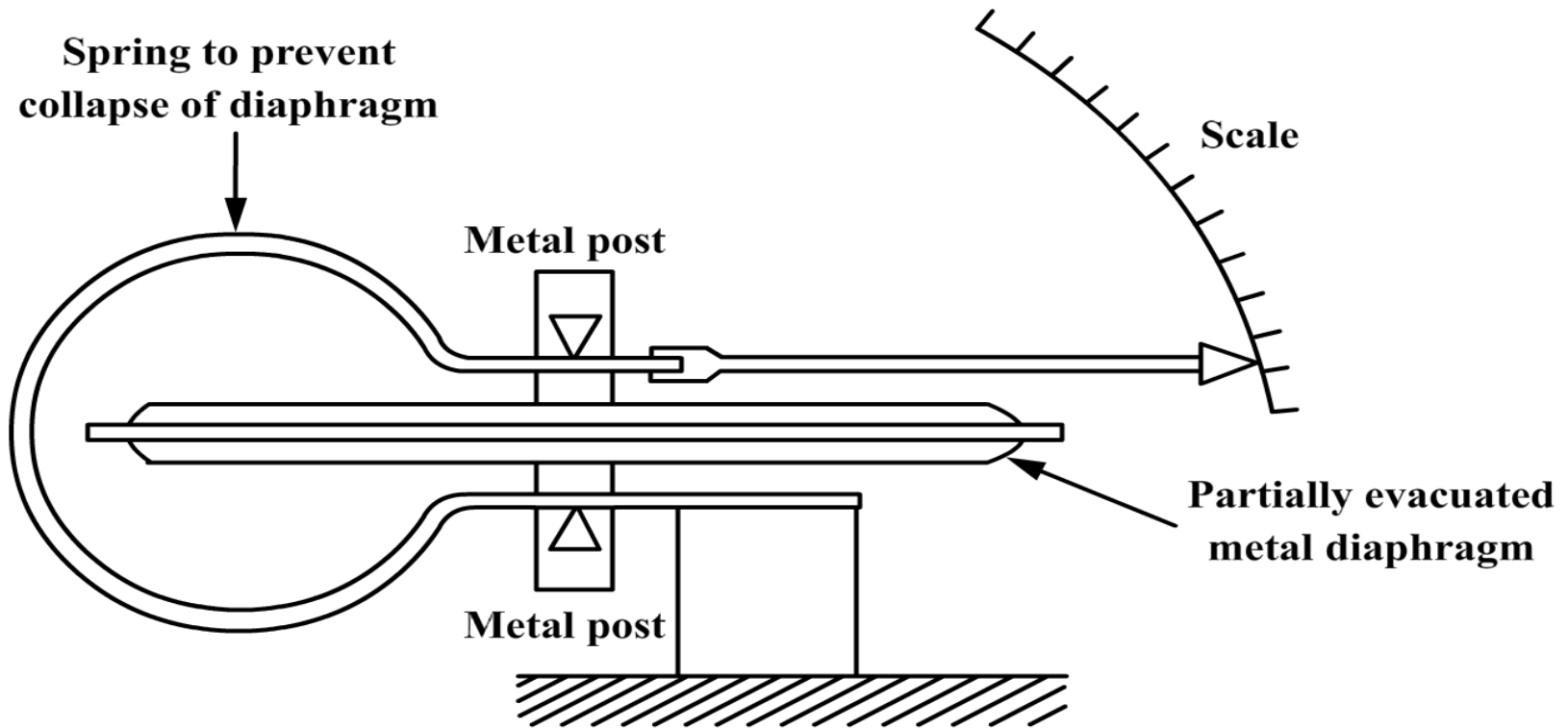

# Pressure

## Pressure Transducers

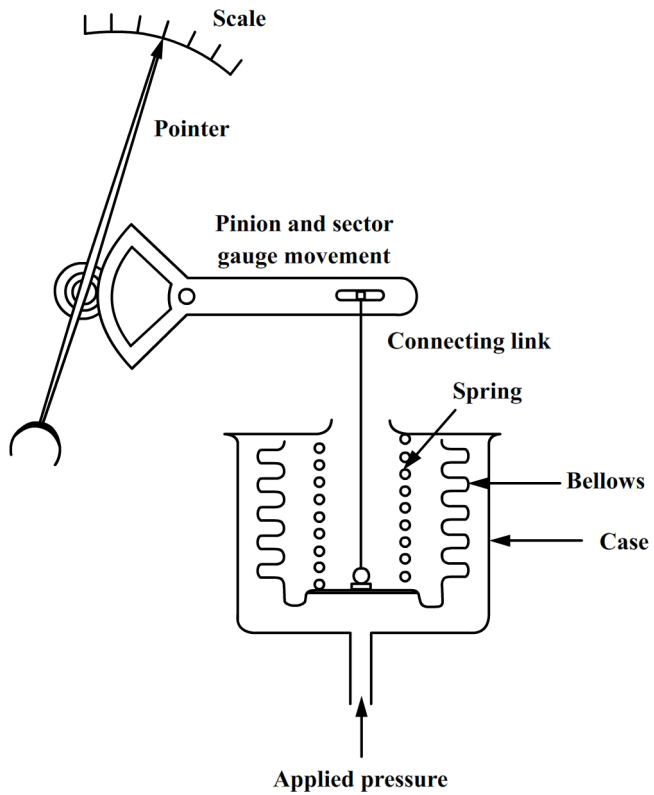

Mechanical pressure transducer

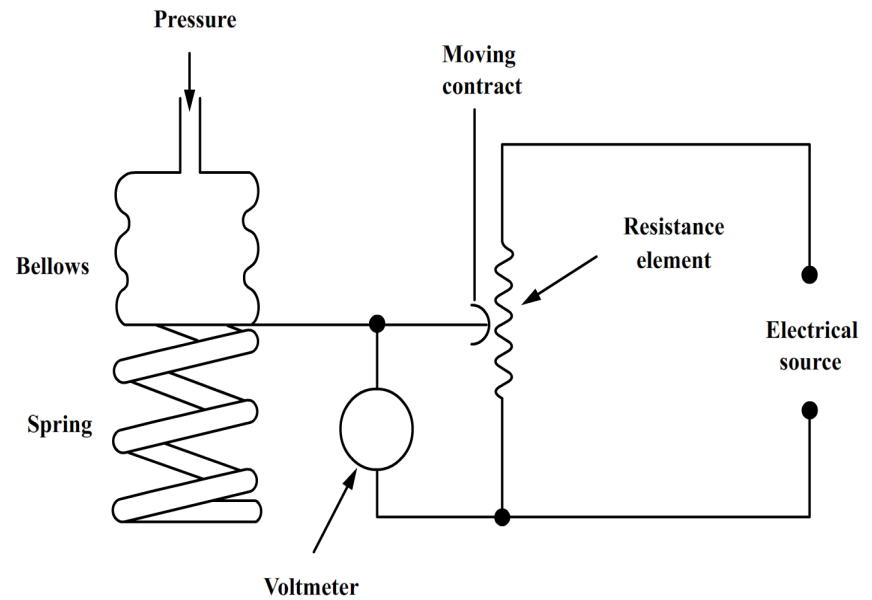

Electrical pressure transducer

# Pressure

## Gauge Pressure

- Pressure of a system relative to ambient barometric pressure.

## Absolute Pressure

- Gauge pressure added algebraically to the prevailing atmospheric pressure.

$$P = P_b + p_g$$

Where:  $P$  = absolute pressure  
 $P_b$  = atmospheric pressure  
 $p_g$  = gauge pressure

(Eq. 2-5)

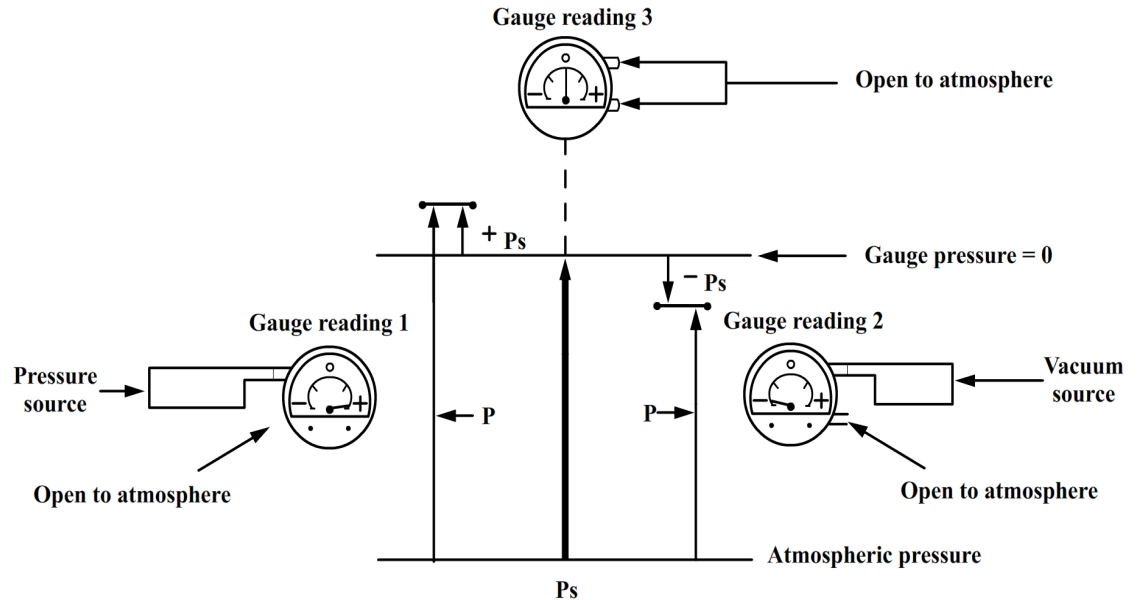

Absolute-atmospheric-gauge pressure relationship

# Pressure

## The Concept of Pressure-Head



- Height of a column of fluid required to produce a given pressure at its base

$$p = \rho_f h \left( \frac{g}{g_c} \right)$$

Where:

$p$	=	pressure, force/area
$\rho_f$	=	density of fluid, mass/volume
$g$	=	local acceleration due to gravity, length/time <sup>2</sup>
$g_c$	=	dimensional constant
$h$	=	pressure-head in terms of $\rho_f$ length

**Eq. 2-6**

# Pressure



## Dalton's Law of Partial Pressure

- *The pressure exerted by one component of a gas-mixture is called its partial pressure. The total pressure of the gas-mixture is the sum of the partial pressures.*

$$P_{total} = \sum P_i$$

Where:  $P_{total}$  = total pressure exerted by the system  
 $P_i$  = pressure of each component of the system  
 $\sum P_i$  =  $p_1 + p_2 + \dots + p_{19}$

( $\sum$  = sum of)

# The Ideal Gas Laws

## Boyle's Law

- When the *temperature* ( $T$ ) is held constant, the *volume* ( $V$ ) of a given mass of an ideal gas of a given composition varies inversely as the absolute pressure ( $P$ )

$$V \propto \frac{1}{P} \quad (\text{at constant } T)$$

( $\propto = \text{proportional to}$ )

## Charles' Law

- When the *pressure* ( $P$ ) is held constant, the *volume* ( $V$ ) of a given mass of an ideal gas of a given composition varies directly as the *absolute temperature* ( $T$ )

$$V \propto T \quad (\text{at constant } P)$$



# The Ideal Gas Laws

## The Law for Ideal Gases

$$PV = nRT$$

Where :  
 $P$  = absolute pressure  
 $V$  = volume of a gas  
 $T$  = absolute temperature  
 $R$  = universal gas-constant  
 $n$  = number of moles of a gas

$$n = \frac{m}{M}$$

Where:  $m$  = mass of a gas  
 $M$  = molecular weight of a gas

Therefore:

$$PV = nRT = \frac{m}{M} RT$$



# The Ideal Gas Laws

## Molar Volume ( $\bar{V}$ )

$$\begin{aligned} \text{If: } P &= 760 \text{ mm Hg} \\ n &= 1 \text{ mole} \\ R &= \\ T &= 273 \text{ K} \\ V &= V (\text{molar volume}) \end{aligned}$$

$$\text{then: } P \times V = n \times R \times T$$

$$(760 \text{ mm Hg}) (V) = (1 \text{ g-mole}) \left( 62.4 \frac{\text{L} \cdot \text{mm Hg}}{\text{g-mole K}} \right) (273 \text{ K})$$

$$V = \frac{(1)(62.4)(273)}{760} \text{ L}$$

$$V = 22.414 \text{ L} = \bar{V}$$





# Gas Density

$$PV = nRT = \frac{m}{M}RT$$

$$\frac{m}{V} = \rho = \frac{PM}{RT}$$

Where:

$\rho$	= density
$P$	= absolute pressure
$M$	= molecular weight
$T$	= absolute temperature
$R$	= universal gas constant

$$\rho = \frac{M \frac{298}{T} \frac{P}{760}}{24.46}, \text{ corrected to standard temperature and pressure conditions}$$

Where:

$\rho$	= gas density (g/L)
$M$	= molecular weight (g/g-mole)
24.46	= molar volume (L/g-mole)
298	= temperature (K) at standard conditions
$T$	= temperature (K) at actual conditions
760	= pressure (mm Hg) at standard conditions
$P$	= pressure (mm Hg) at actual conditions



# Gas Density

## Standard Conditions for Atmospheric Sampling

25°C or 298 K, and 760 mm Hg. (“Standard” ambient sampling conditions)



$$V_2 = (V_1) \left( \frac{P_1}{P_2} \right) \left( \frac{T_2}{T_1} \right)$$

$$V_2 = (V_1) \left( \frac{P_1}{760 \text{ mm Hg}} \right) \left( \frac{298 \text{ K}}{T_1} \right)$$

$$V_2 = (V_1)(0.39) \left( \frac{P_1}{T_1} \right)$$

Where:

$V_2$  = volume of gas at 2nd conditions or at  $P_2$  and  $T_2$ , L

$V_1$  = volume of gas at 1st conditions of  $P_1$  and  $T_1$ , L

$T_1$  = initial temperature of gas, K

$T_2$  = final temperature of gas--in this case, 298 K

$P_1$  = initial pressure of gas, mm Hg

$P_2$  = final pressure of gas--in this case, 760 mm Hg

$$0.39 = \frac{298}{760}$$



# Gas Density

## Origin and Definition of Viscosity

- The result of intermolecular cohesive forces and momentum transfer between flowing strata caused by molecular agitation perpendicular to the direction of motion.
- Resistance *to flow*

$$g_c T = \mu \frac{dv}{dy}$$

Where:

$g_c$  = dimensional constant

$T$  = unit shearing stress between adjacent layers of fluid

$\frac{dv}{dy}$  = velocity gradient

$\mu$  = proportionality constant (viscosity)

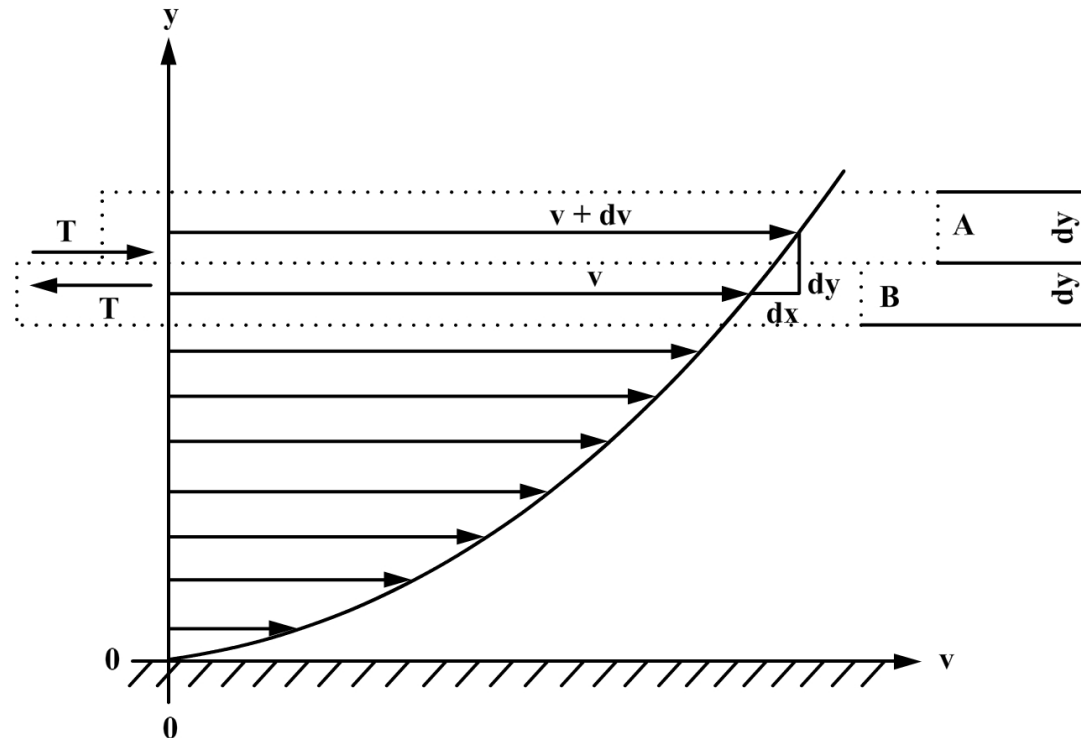

Velocity gradient

# Gas Density

## Kinematic Viscosity



$$\nu = \frac{\mu}{\rho}$$

Where:

$\nu$  = kinematic viscosity

$\mu$  = viscosity of the gas

$\rho$  = density of the gas (note the absence of dimensions of force)

# Gas Density

## Liquid Viscosity versus Gas Viscosity



*Liquid Viscosity*

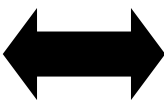

Temperature

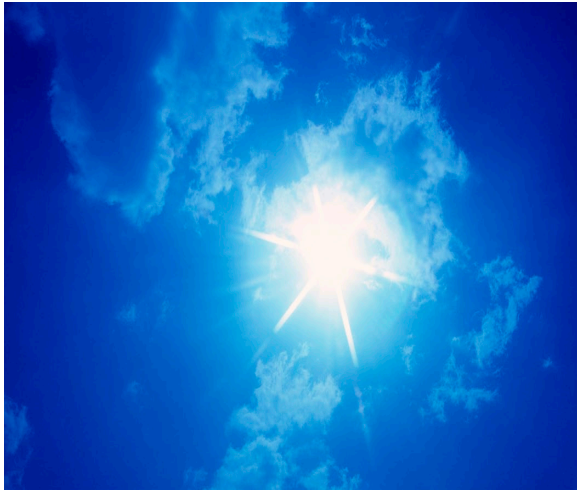

*Gas Viscosity*





# Gas Density

## Determination of Viscosity of Gases

Viscosity of air at 1 atmosphere\*

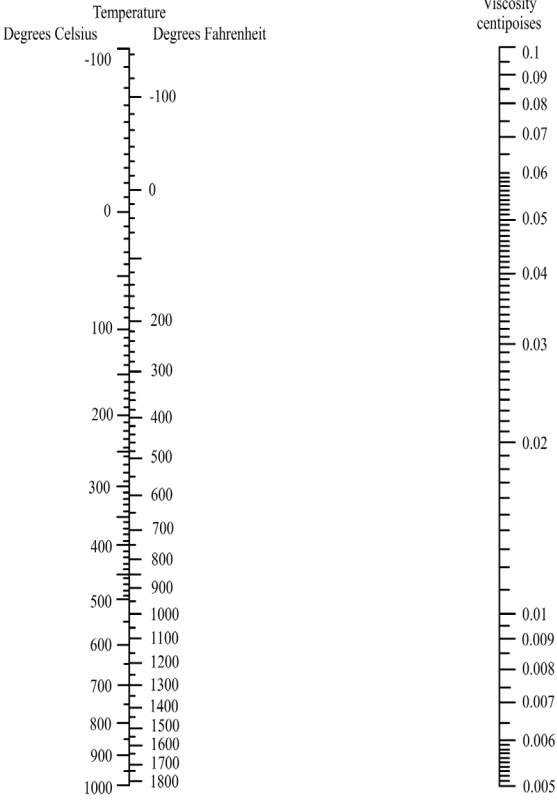

$$\frac{\mu}{\mu^{\circ}} = \left( \frac{T}{273.1} \right)^n$$

Where:

- $\mu$  = viscosity at temperature T (K)
- $\mu^{\circ}$  = viscosity at 0°C and prevailing pressure
- T = absolute prevailing temperature (K)
- n = an empirical exponent (n = 0.768 for air)

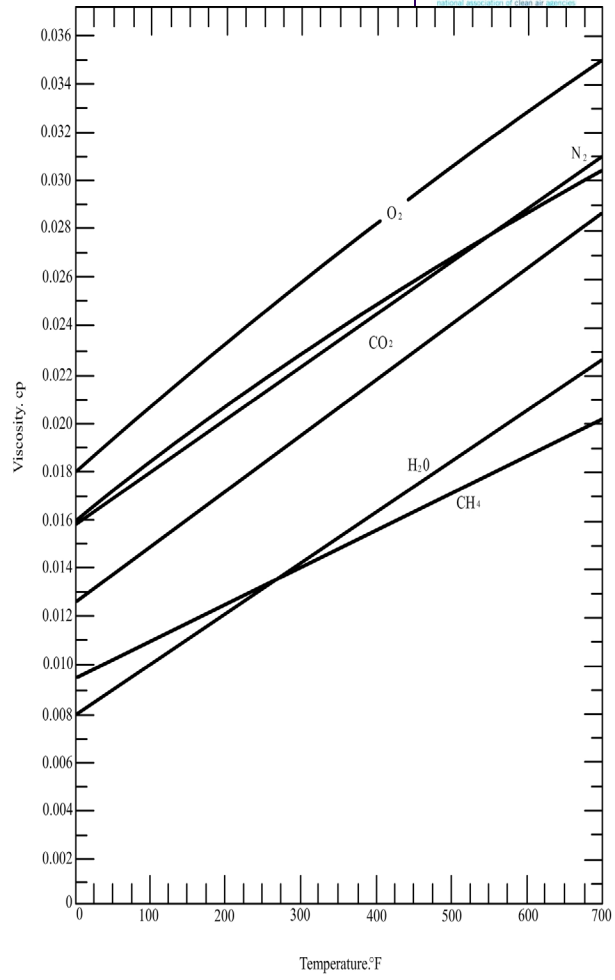

(1)centipoise	$(10)^{-2} \frac{\text{gm}}{\text{cm} \cdot \text{sec}}$	$209(10)^{-6}$	$2.09(10)^{-6}$	$6.72(10)^{-4}$
	$(10)^{-2}$ poise	$\frac{1\text{b} \cdot \text{sec}}{\text{ft}^2}$	$\frac{\text{slug}}{\text{ft} \cdot \text{sec}}$	$\frac{1\text{b} \cdot \text{sec}}{\text{ft} \cdot \text{sec}}$

\*Perry, J.H. Chemical engineer's Handbook. McGraw-Hill Book Co., New York (1950)

Viscosity nomograph for air

Viscosity nomograph of various gases at 1 atmosphere

# Reynolds Number

$$Re = \frac{Lv\rho}{\mu} \quad Re = \frac{Dv\rho}{\mu} \quad Re_p = \frac{D_p v_p \rho}{\mu}$$

*Where:*

$Re$  = Reynolds Number

$L$  = characteristics system dimension

$D$  = pipe diameter

$v$  = fluid velocity

$\rho$  = fluid density

$\mu$  = fluid viscosity



# Summary of Useful Equations



- Temperature
- Pressure
- Ideal Gas Law
- Gas Density
- Viscosity
- Reynolds Number

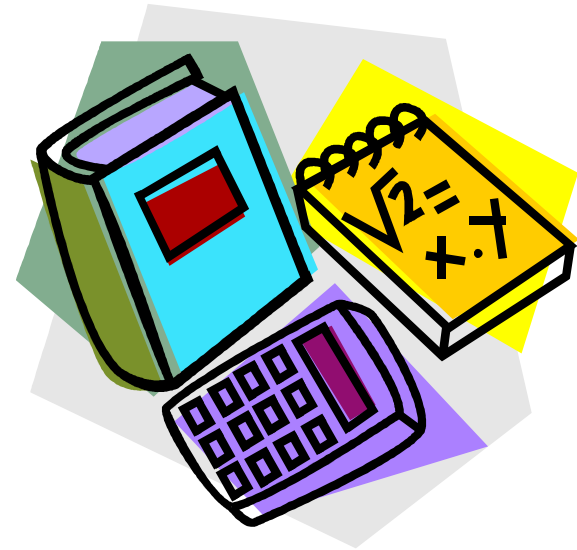



# Units of Measurements

Recommended Units (Refer to page 2-25 in Student Manual)



**Table 2-1. Measurement units**

Parameter	Units in use	Unit recommended	Typical range
Particle fallout	Tons per square mile per month Tons per square mile per year Pounds per acre per month Pounds per acre per year Pounds per thousand square feet per month Ounces per square foot per month Grams per square foot per month Grams per square meter per month Kilograms per square kilometer per month Grams per month per 4-inch or 6-inch jar Milligrams per square inch per month Milligrams per square centimeter per time interval	mg/cm <sup>2</sup> /mo (or yr)	0.5 to 135 mg/ cm <sup>2</sup> /mo
Outdoor airborne particulate matter	Milligrams per cubic meter Parts per million by weight Grams per cubic foot Grams per cubic meter Micrograms per cubic meter Micrograms per cubic foot Pounds per thousand cubic feet	µg/m <sup>3</sup> (std)	10 to 5000 µg/ m <sup>3</sup> as TSP 30 to 140 µg/ m <sup>3</sup> as PM <sub>10</sub> <sup>[1]</sup> 5 to 20 µg/ m <sup>3</sup> as PM <sub>2.5</sub> <sup>1</sup>

<sup>[1]</sup> Based on National Trends data for PM<sub>10</sub> & PM<sub>2.5</sub>.

# Units of Measurements

## Conversion Problems

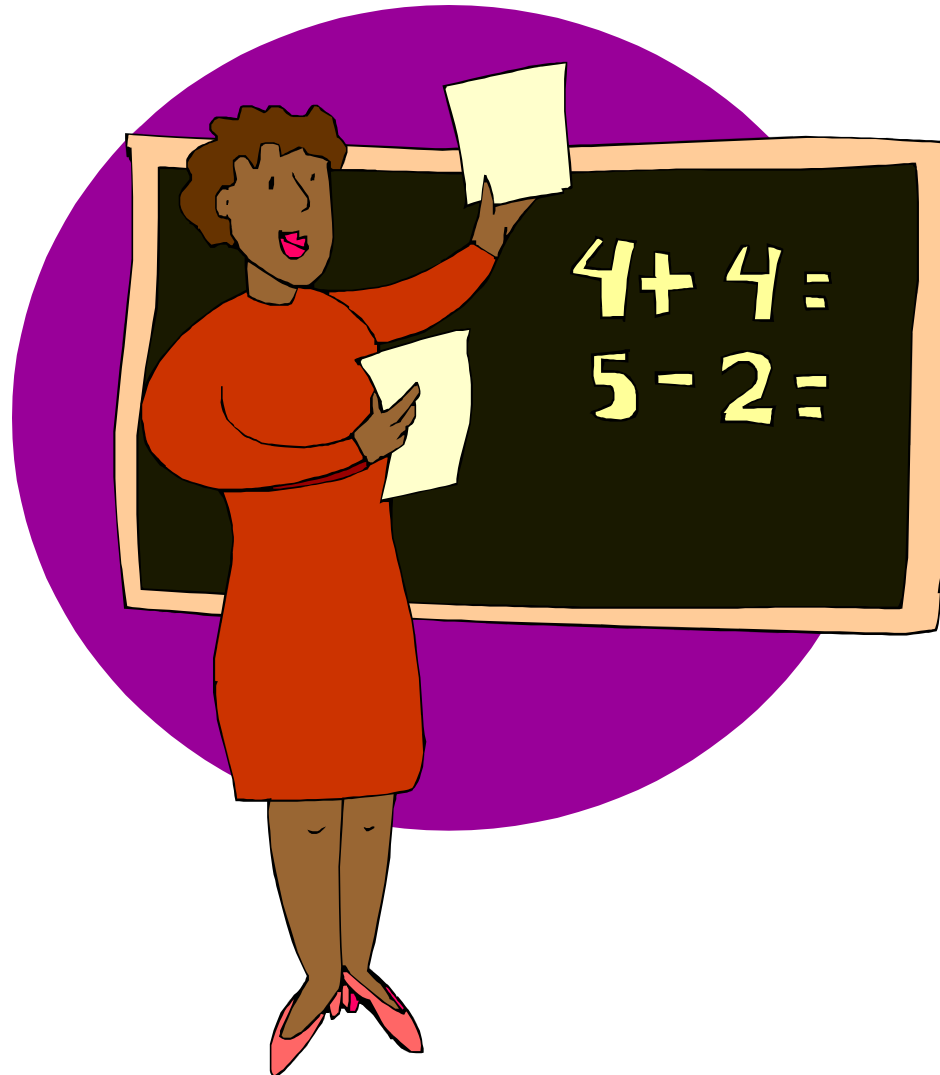

# APTI 435: Atmospheric Sampling Course Chapter 2



Questions?



Summary

# Chapter 3

## Air Measuring Instruments



---

### APTI 435: Atmospheric Sampling Course



# Terminal Learning Objective

- At the end of this chapter, the student will be able to identify, classify, and determine appropriate use of air measuring instruments.

# Enabling Learning Objectives



- 3.1- Describe the relationship of air movers to other sampling system components and its classification.
- 3.2- Identify air mover selection criteria.
- 3.3- Define and classify pumps.
- 3.4- Describe the operation principle and driving force of ejectors.
- 3.5- Describe the principle of operation and sampling procedures of liquid displacers.
- 3.6- Describe the principle of operation and sampling procedures of air displacers.
- 3.7- Identify flow rate control
- 3.8- Identify flow rate for sampling.
- 3.9- Identify air measuring instruments.
- 3-10- Identify the seven volume meters that are commonly used in air sampling and analysis.
- 3-11- Describe rate meters.
- 3-12- Identify and describe velocity meters and their standard procedures
- 3-13- View sample problems.
- 3-14- Describe PM<sub>2.5</sub> flowmeters and devices.

# Introduction to Air Movers

## Relationship of Air Movers to Other Sampling System Components

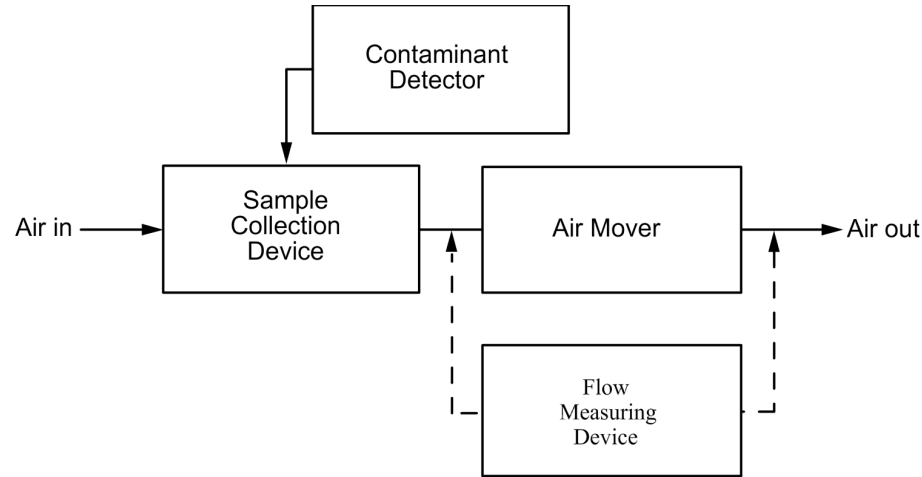

## Air Mover Classification

Classified by:

- Function
- Capacity
- “Driving” force
- Principle of operation

Types discussed:

- Pumps
- Ejectors
- Liquid displacers
- Air displacers

# Air Mover Selection Criteria

- Pollutant Concentration and Sampling Time
- Sampling Rate Required
- Physical and Chemical Nature of Air to be Sampled
- Portability of Air Mover
- Air Mover Noise
- Air Mover Maintenance
- Resistance
- Constant Flow Rate

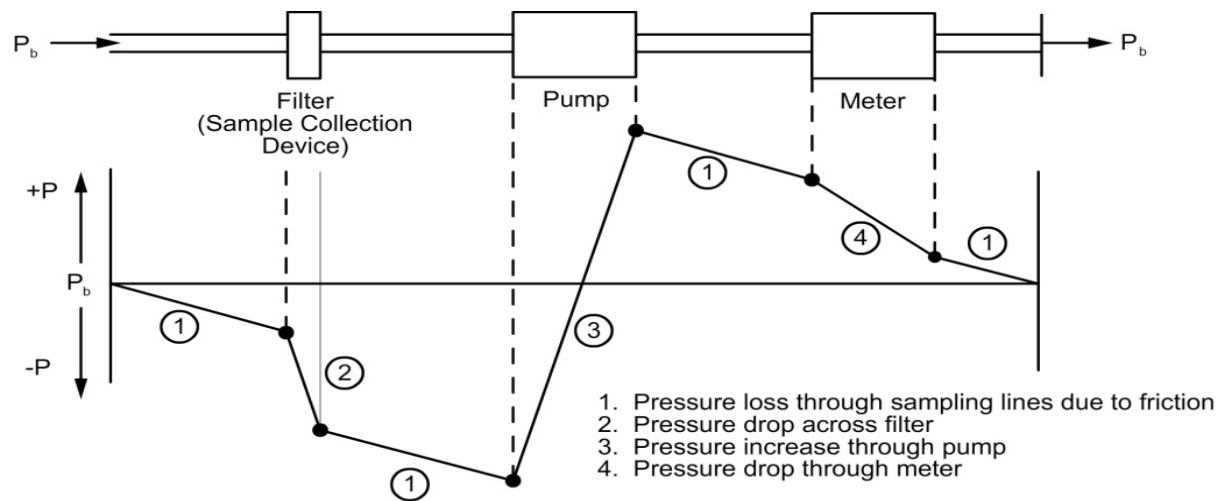

Pressure profile for basic sampling apparatus



# Pumps

## Definition and Classification

- Devices that raise or transfer fluids

### Classes:

- *Positive displacement pumps*
- *Centrifugal pumps*

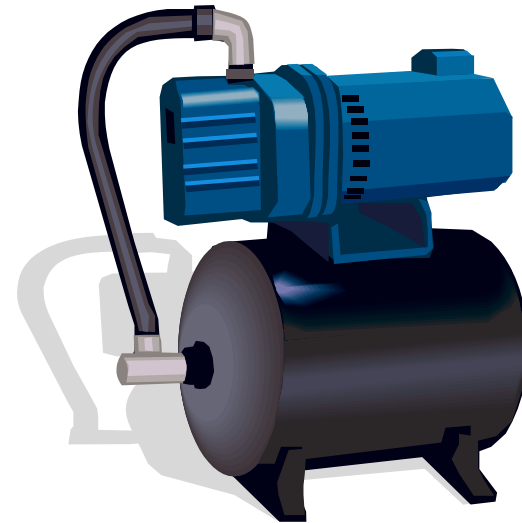
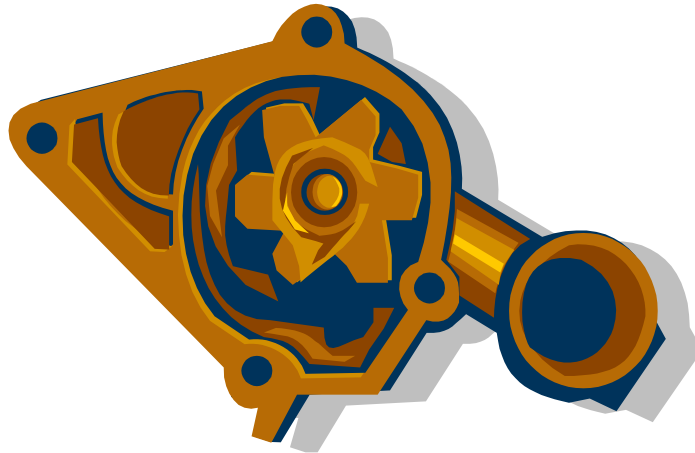

# Pumps

## Positive displacement pumps

Capacity (Q)

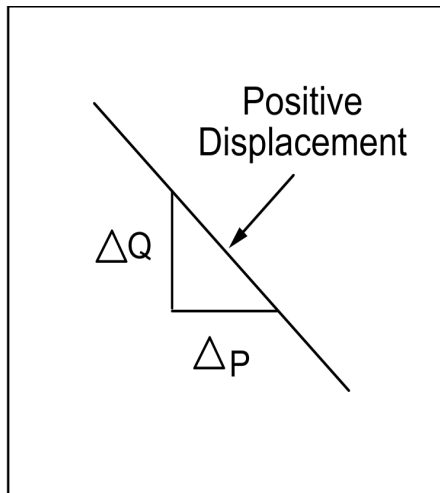

Pressure (p)

Principle Operation	Type of Pump
Reciprocating	Piston Plunger Diaphragm
Rotary (not discussed in this manual)	Gear Lobe Vane Screw Rotary Plunger

### Classification of positive displacement pumps

#### Positive displacement pump

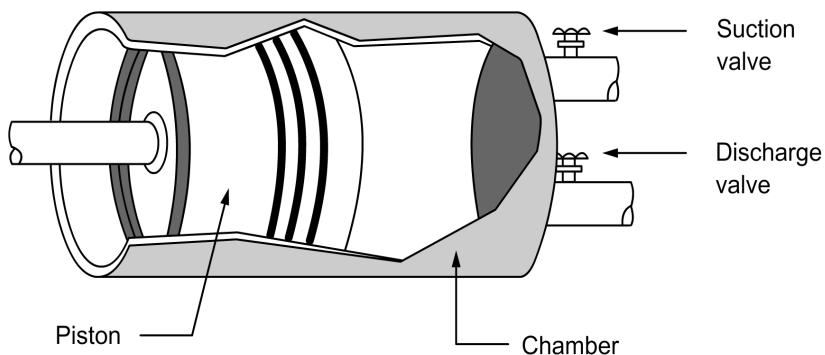

Piston pump

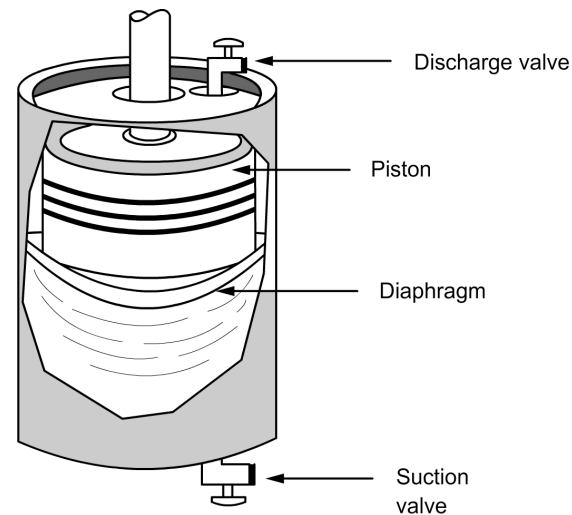

Diaphragm pump

# Pumps

## Centrifugal Pumps

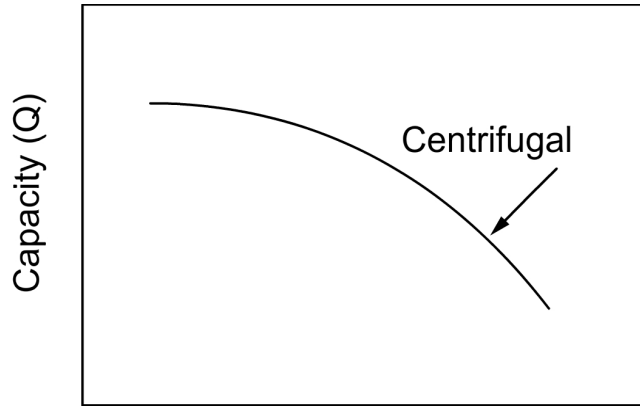

Pressure (p)

Centrifugal pump

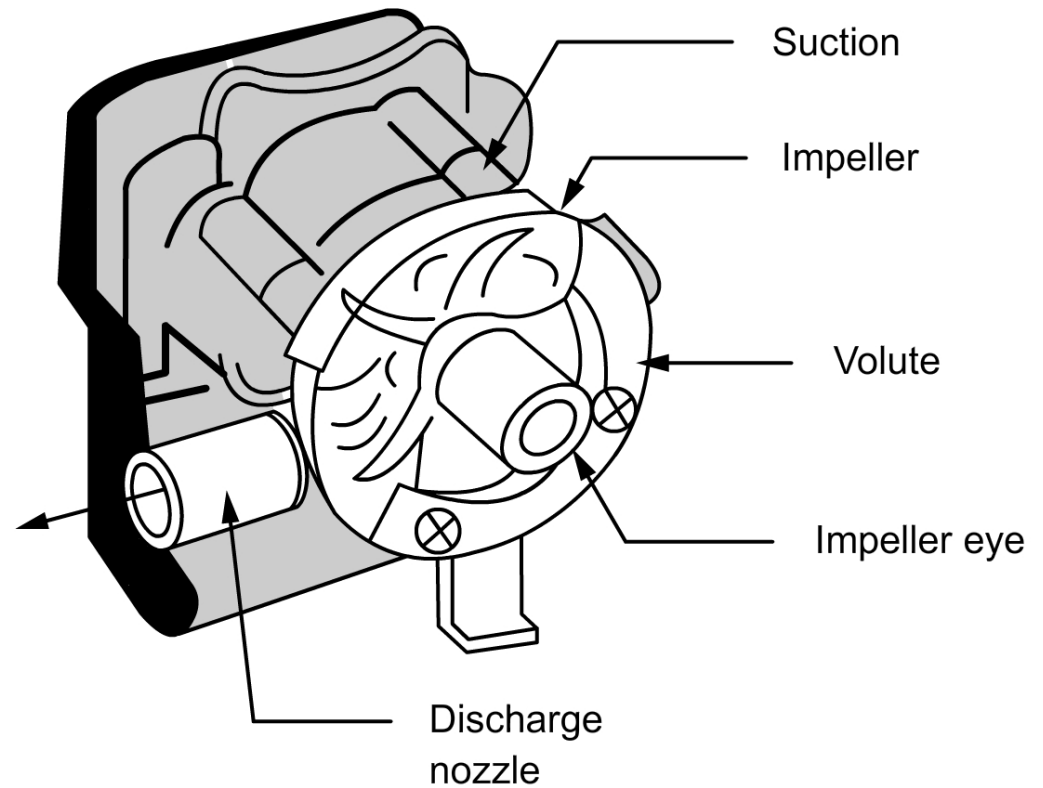

Centrifugal pump operation

# Pumps

## “Driving Forces” for Pumps



### Manual

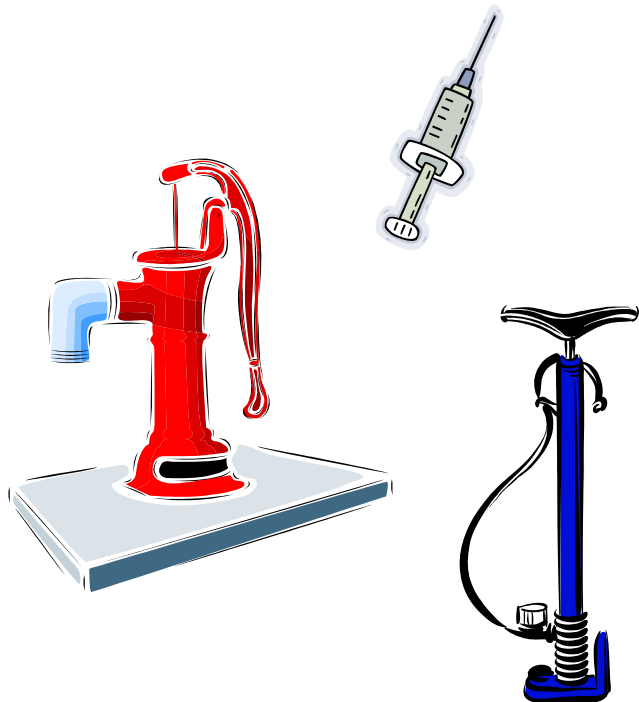

### Motors

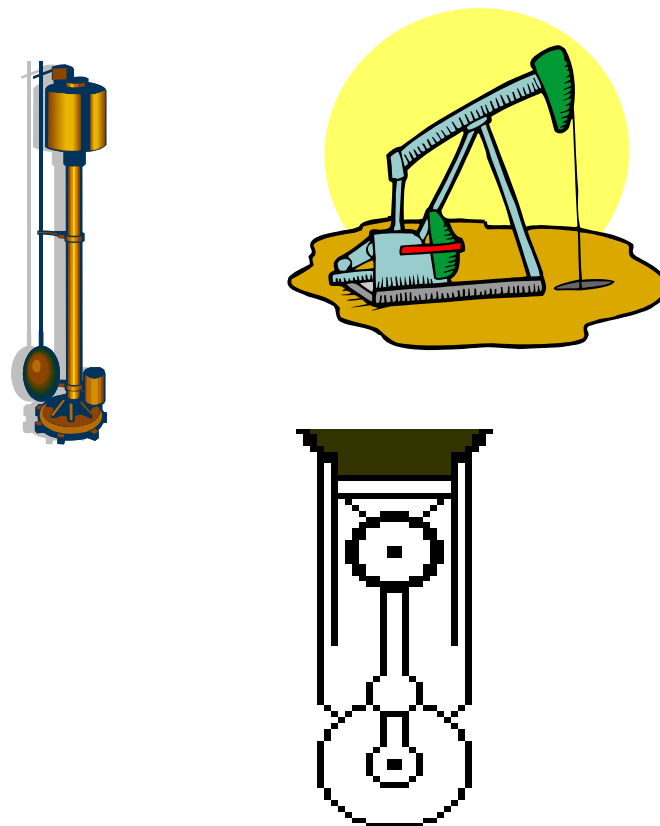

# Pumps

## Characteristic Curves

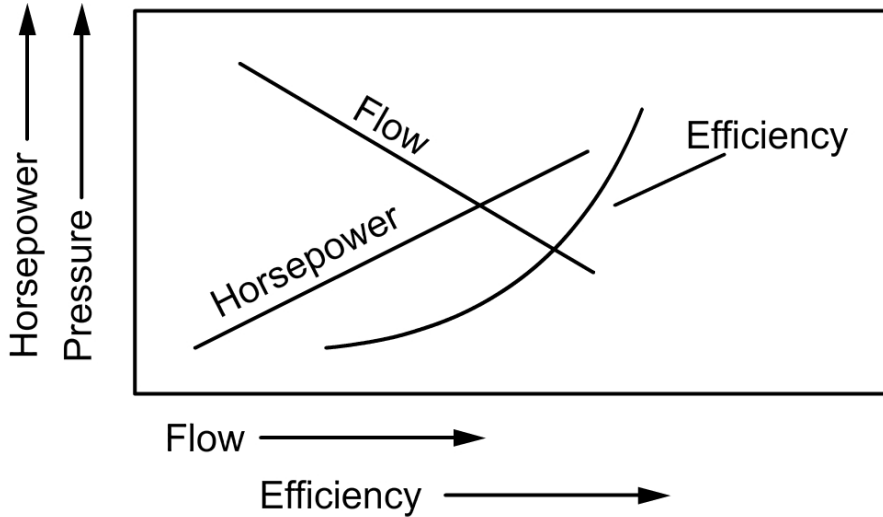

Characteristic curve for a positive displacement pump

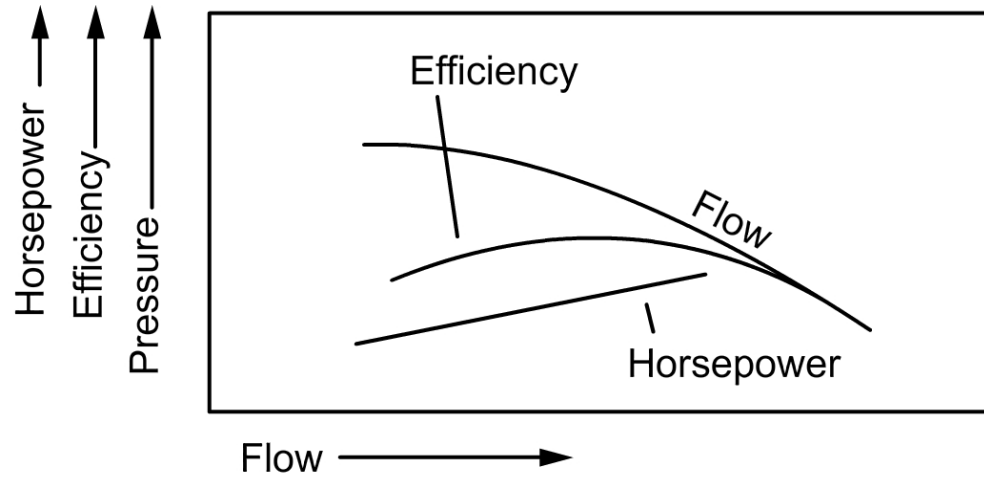

Characteristic curve for a centrifugal pump

# Pumps

Selecting a Pump (Refer to Page 3-11 in Student Manual)



<b>Pump type</b>	<b>Advantages</b>	<b>Disadvantages</b>
Piston pump (reciprocating)	<ol style="list-style-type: none"><li>1. Can operate at high suction pressure</li><li>2. Can be metered</li></ol>	<ol style="list-style-type: none"><li>1. Small capacity</li><li>2. Seal required between piston &amp; piston chamber</li><li>3. Working parts (check valves &amp; piston rings)</li><li>4. Pulsating flow</li><li>5. Moderate maintenance</li></ol>
Diaphragm pump (reciprocating)	<ol style="list-style-type: none"><li>1. Wide range of capacities</li><li>2. No seal required</li><li>3. Good in continuous operation</li></ol>	<ol style="list-style-type: none"><li>1. Limited construction materials</li><li>2. Operation at limited suction pressures</li><li>3. Pulsating flow</li><li>4. Periodic diaphragm replacement</li><li>5. Moderate maintenance</li></ol>
Centrifugal pump	<ol style="list-style-type: none"><li>1. Large range of capacities</li><li>2. No close clearance</li><li>3. Can obtain high suction heads by multistages</li><li>4. Light maintenance</li></ol>	<ol style="list-style-type: none"><li>1. No small capacities</li><li>2. Turbulence</li><li>3. Operational noise</li></ol>

Pump comparison

# Pumps

## Pump Gauges

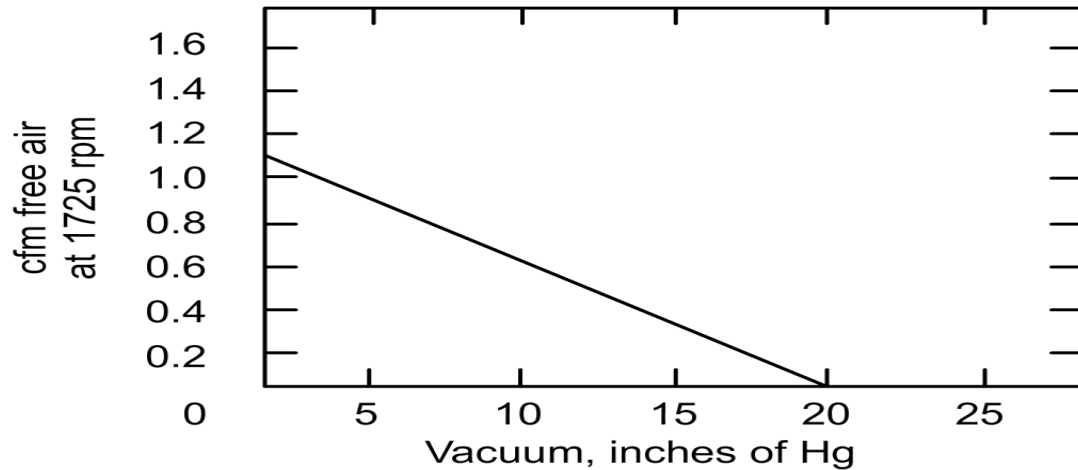
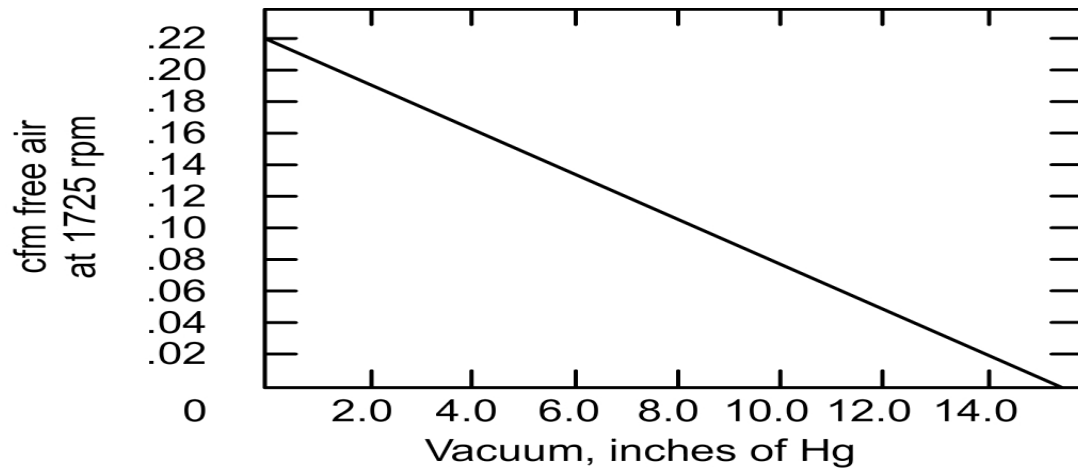

Pressure-flow relationship for metal bellows pumps for vacuum  
(continuous operation capability)

# Ejectors

## Principle of Operation

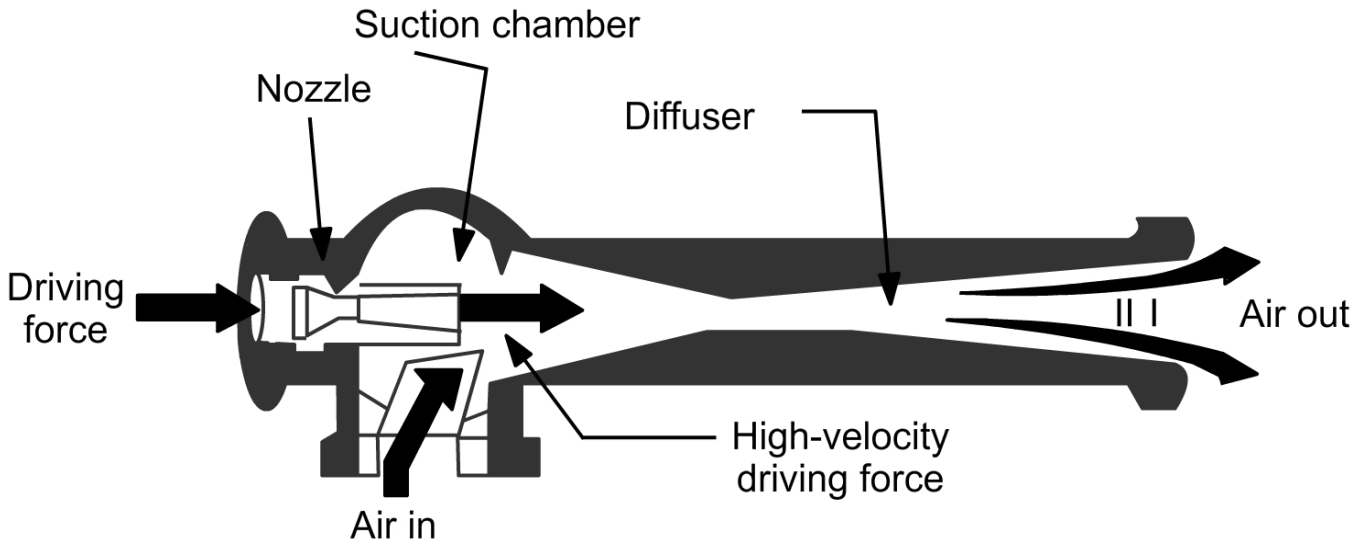

Ejector operation

- Driving Forces – (water, steam, CO<sub>2</sub> ...)
- Sampling use of Injectors



# Liquid Displacers

## Principle of Operation

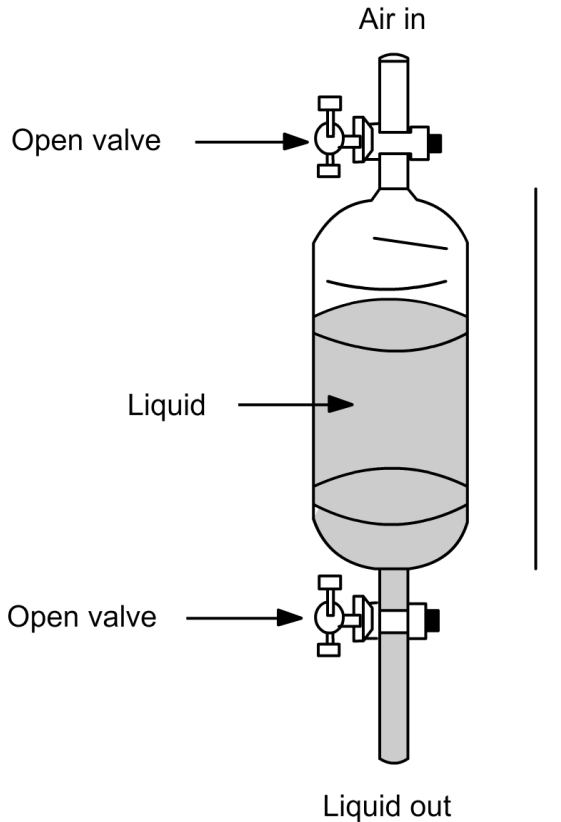

Liquid displacement

## Sampling by Use of Liquid Displacement

- Usually used only for grab sampling
- Sample volume capacity is limited to the size of the liquid container
- Examples of liquids used are water, mercury (Hg), and organic solvents

# Air Displacers

## Principle of Operation and Sampling



### Evacuated Flasks PO

- Evacuated by vacuum pump
- Sealed and transported to location
- Valve opened, surrounding air enters
- Valve closed confining sample

### “Plastic” Bags PO

- Tedlar, Mylar, Teflon, aluminized PVC
- Mounted within a rigid, airtight outer container
- Create a slight vacuum around the bag
- No rigid container, pump directly in plastic bag

### Evacuated Flasks Sampling

- Used only for grab sampling
- Only small sample volumes
- Summa canister hold vacuum for up to 30 days
- Possibility of flask “implosion” when using glass containers

### “Plastic” Bags Sampling

- Used only for grab sampling
- Only small sample volumes

# Flow Rate Control

## Control by Diversion

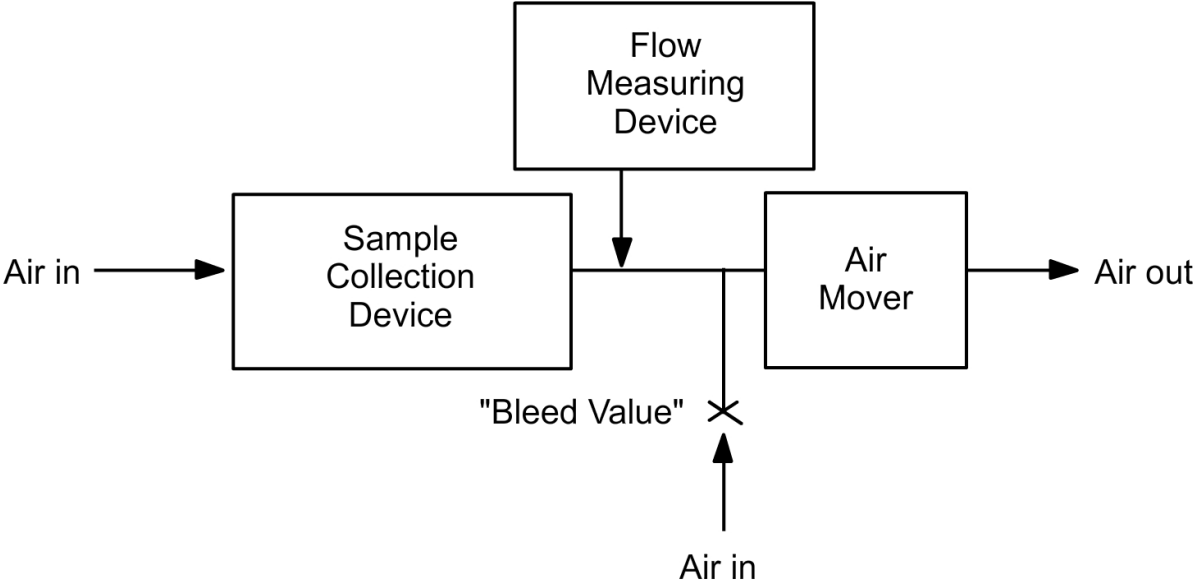

Flow rate control by diversion

# Flow Rate Control

## Resistance Control

- Flow rate decreases as the resistance it must overcome increases
- Partially closing a valve in the intake line creating a greater resistance

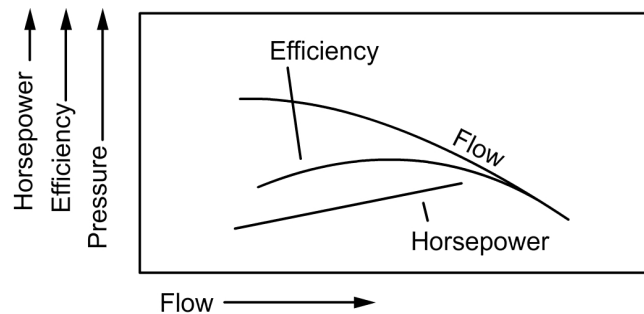
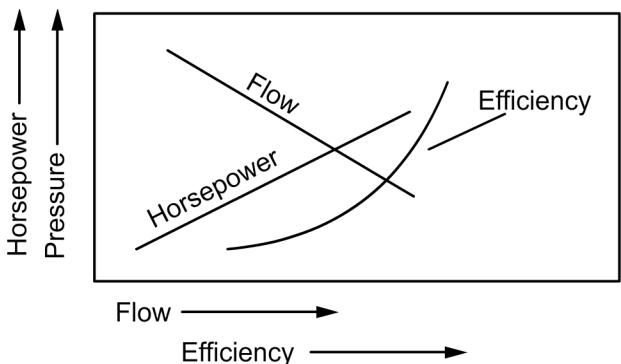

## Driving Force Control

### Examples

- Adjustment of the nozzle opening on an ejector
- Electric motor speed regulation by use of a variable transformer

# Flow Rate Sampling

## Need for Control

To maintain the exact particular flow rate that has been selected for the sampling train.

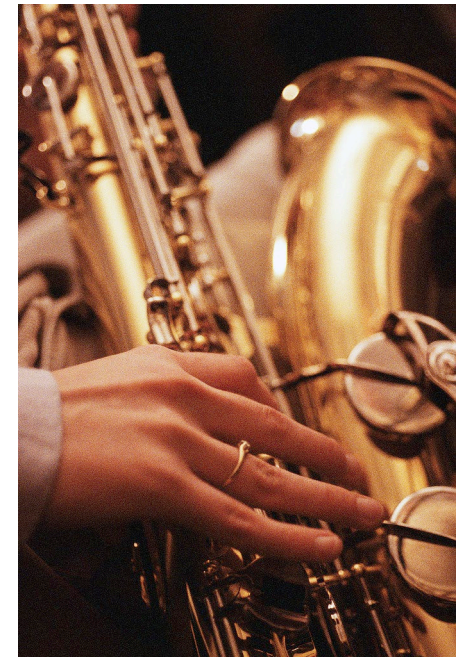
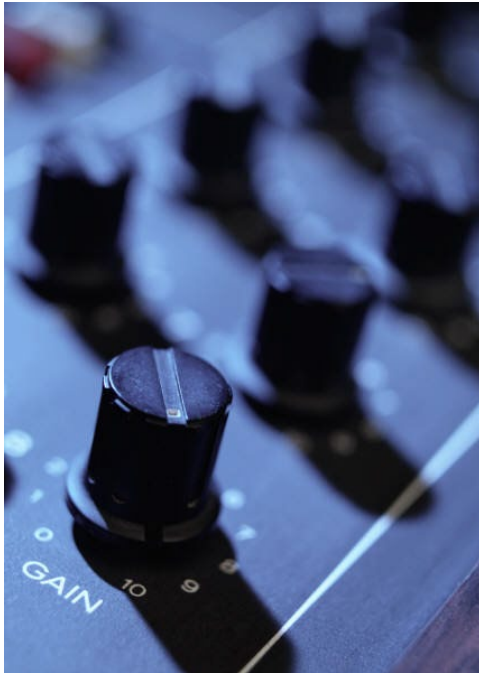

# Flow Rate Sampling

## Control Mechanisms

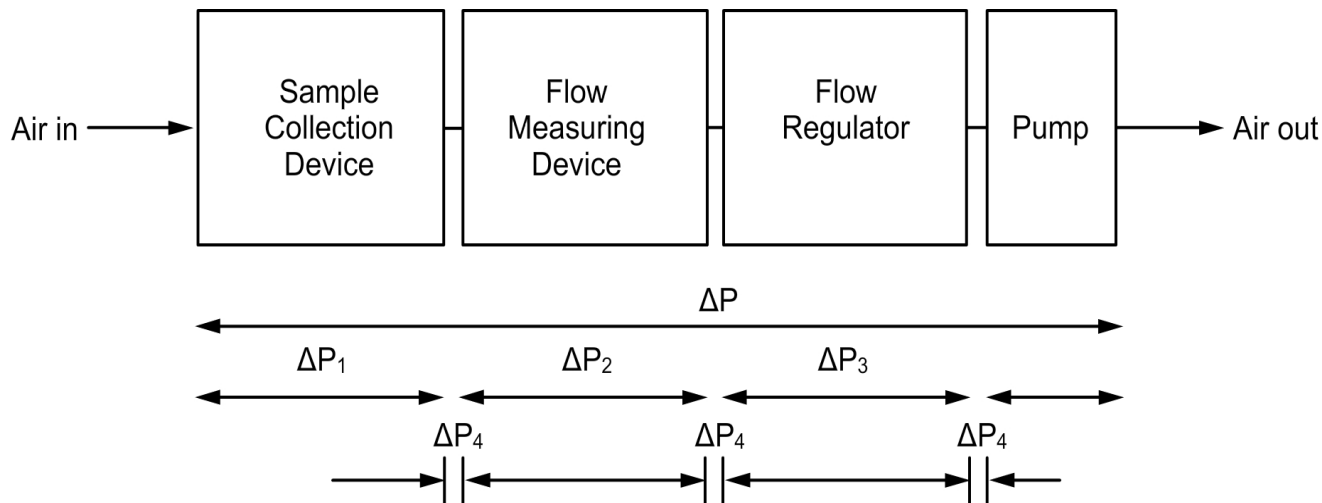

Flow rate control mechanism

$$\text{(Eq. 3-1)} \quad \Delta p = \Delta p_1 + \Delta p_2 + \Delta p_3 + \Delta p_4$$

$$\text{(Eq. 3-2)} \quad \Delta p - \Delta p_2 - \sum \Delta p_4 = \Delta p \text{ adjusted}$$

$$\text{(Eq. 3-3)} \quad \Delta p_2 + \sum \Delta p_4 = \text{constant}$$

$$\text{(Eq. 3-4)} \quad \Delta p_1 + \Delta p_3$$

# Air Measuring Instruments

## Introduction



$$\frac{\mu\text{g}}{M^3} \left( \frac{\text{Mass of pollutant}}{\text{Volume of air sampled}} \right)$$

$$V = Q \times t$$

# Air Measuring Instruments

## Types of Air Measuring Devices

- *Volume meters*
- *Rate meters*
- *Velocity meters*

$$Q = \frac{V}{t}$$

Volume Meter Equation

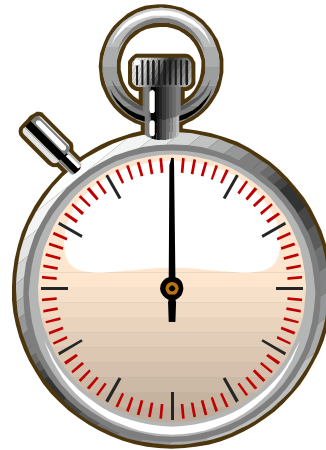

Rate Meters  
Time rate of flow

$$Q = A \times \bar{u}$$

Velocity Meter Equation



# Air Measuring Instruments

## Calibration

- Calibration is the comparison of an output value with a known input value



## Calibration Frequency Conditions

- Instrument use (What are the conditions under which the instrument is used?)
- Instrument users (How many different people use the instrument?  
What are their qualifications?)
- Instrument characteristics (How often does the instrument require calibration under controlled laboratory conditions? How sensitive is the instrument?)
- Regulatory requirements as to how frequently the instrument or device must be calibrated

# Volume Meters

## The Spirometer (or “Bell Prover”) – Primary Standard

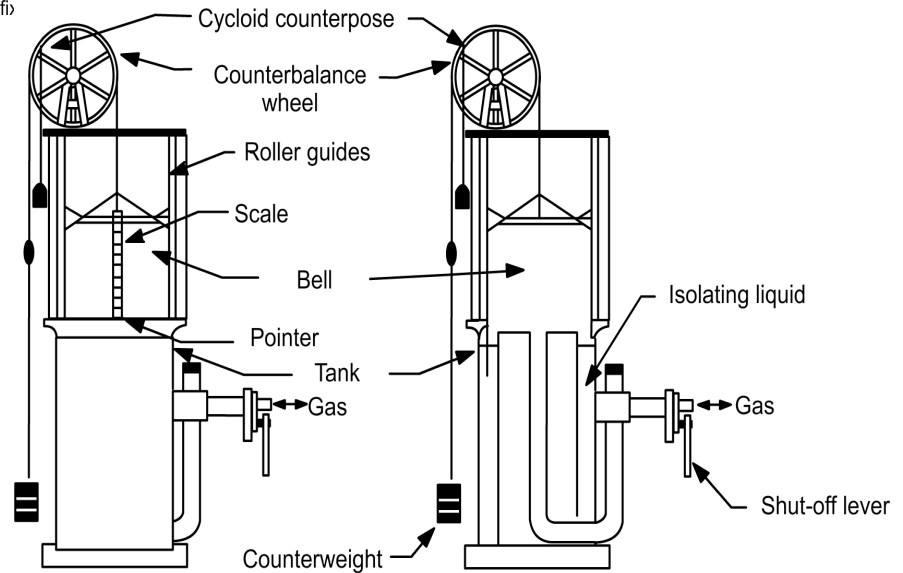
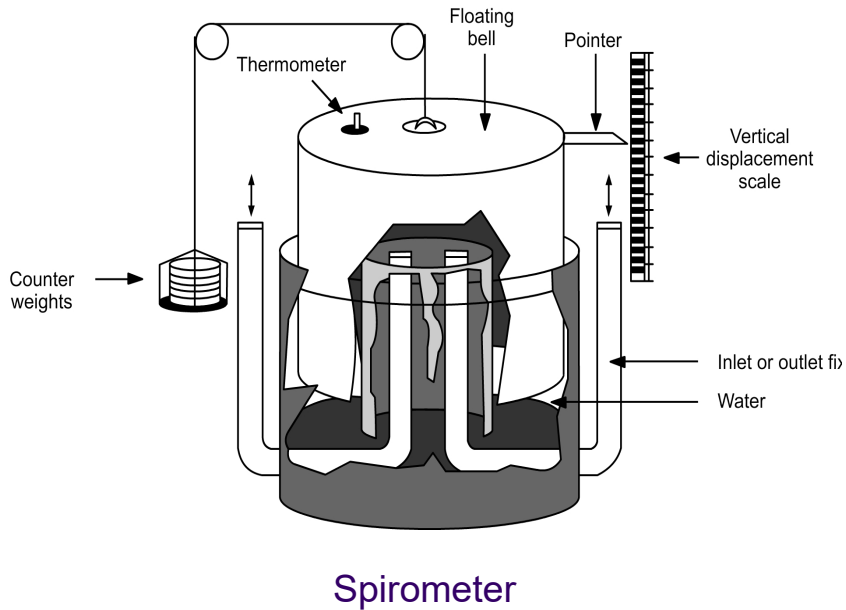

Orthographic and cross-sectional views of a 5-ft<sup>3</sup> spirometer

# Volume Meters

## The Spirometer (or “Bell Prover”) – Primary Standard



$$V = \frac{\pi d^2 h}{4}$$

Where:  $V$  = volume of air passed through spirometer  
 $\pi$  = a constant = 3.14  
 $d$  = diameter of bell  
 $h$  = vertical displacement of bell

$$V_2 = V_1 \left( \frac{P_1}{760 \text{ mm Hg}} \right) \left( \frac{298 \text{ K}}{T_1} \right)$$

Where:  $V_2$  = volume of gas at 2nd conditions or at  $P_2$  and  $T_2$   
 $V_1$  = a volume of gas at 1st conditions of  $P_1$  and  $T_1$   
 $T_1$  = initial temperature of gas, K  
 $T_2$  = final temperature of gas (in this case, 298 K)  
 $P_1$  = initial pressure of gas, mm Hg  
 $P_2$  = final pressure of gas (in this case, 760 mm Hg)

# Volume Meters

## Displacement Bottle Technique - Primary Standard

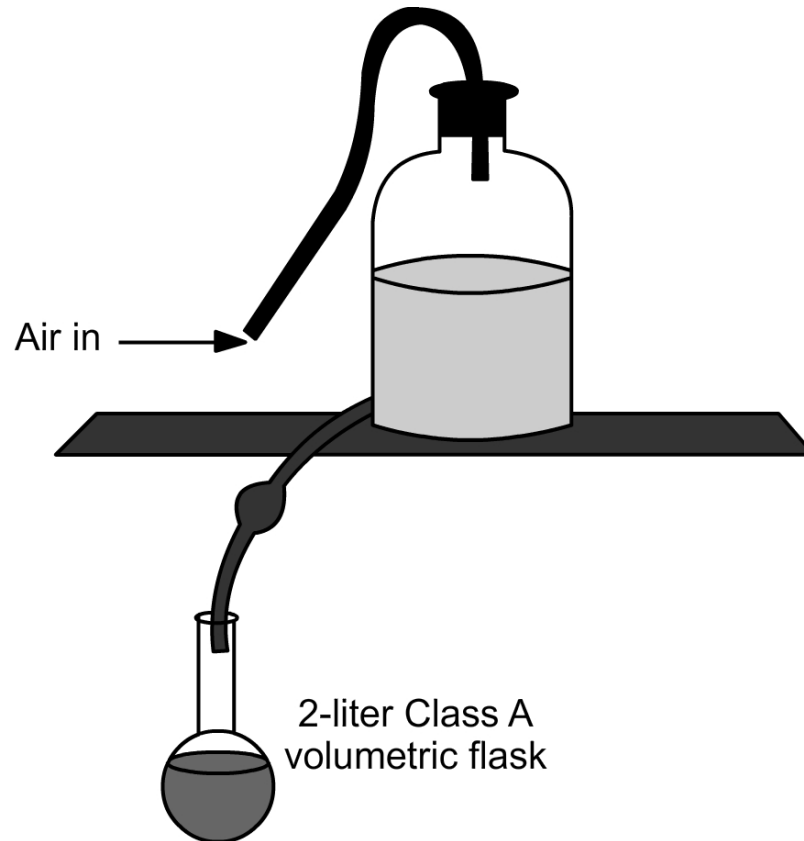

Displacement bottle technique

# Volume Meters

## Frictionless Pistons - Primary Standard

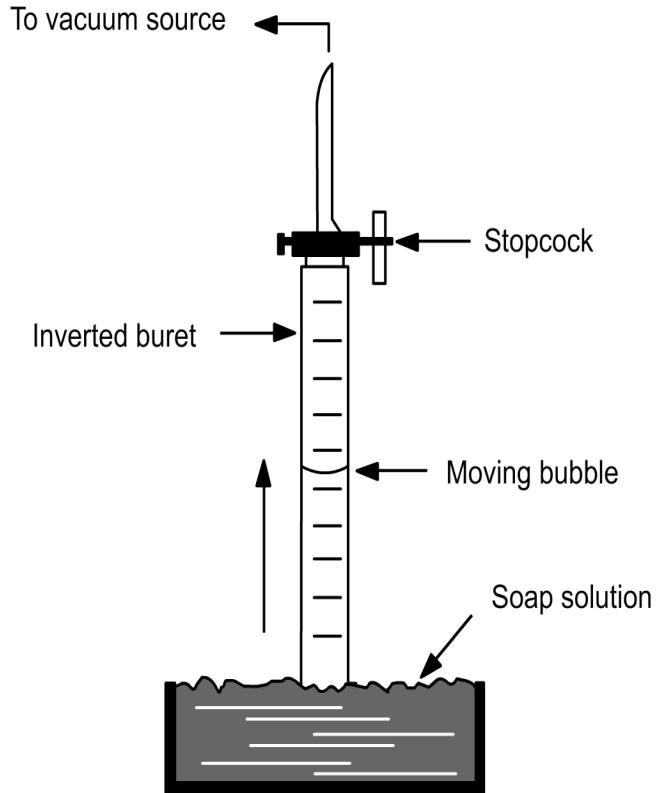

Moving-bubble meter

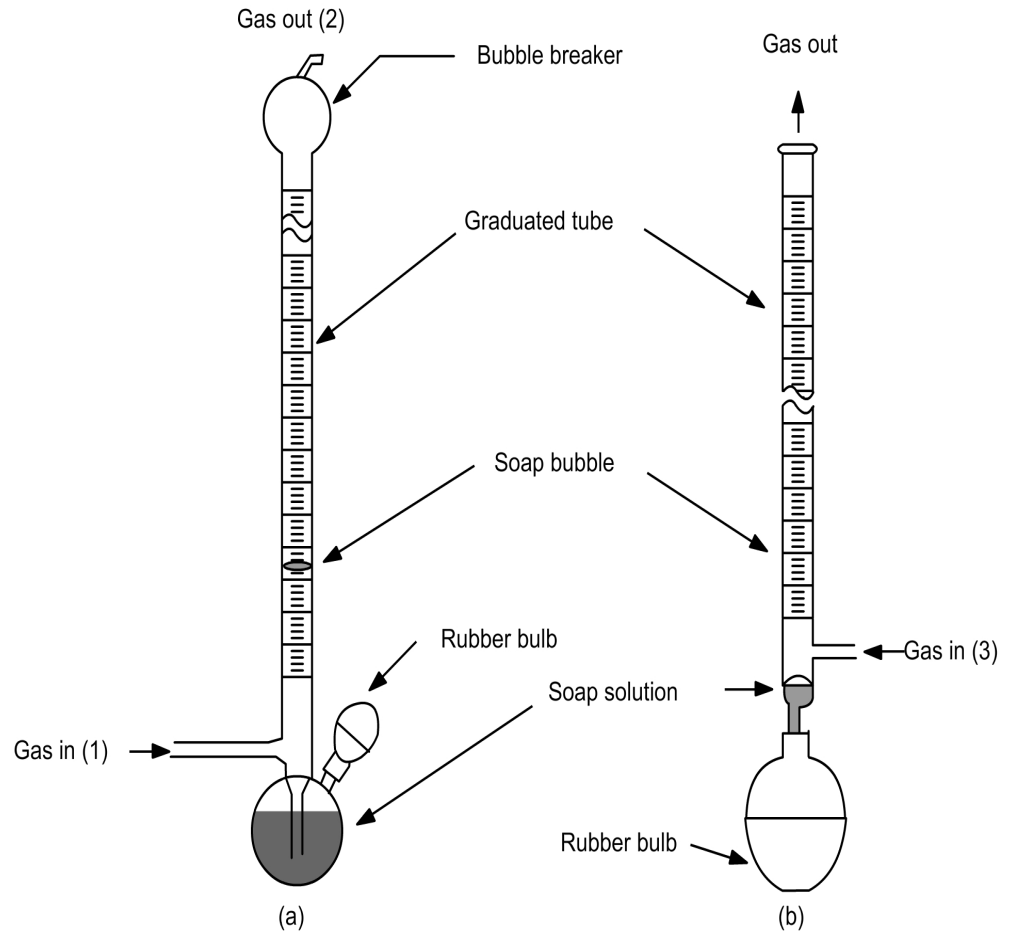

Moving-bubble meters: (a) one with bubble breaker and capability of handling vacuum at (2) or pressure at (1); (b) one capable of handling only pressure at(3)

# Volume Meters

## Frictionless Pistons - Primary Standard



$$V_2 = V_1 \left( \frac{P_1}{760 \text{ mm Hg}} \right) \left( \frac{298 \text{ K}}{T_1} \right)$$

Where:

- $V_2$  = volume of gas at 2nd conditions or at  $P_2$  and  $T_2$
- $V_1$  = a volume of gas at 1st conditions of  $P_1$  and  $T_1$
- $T_1$  = initial temperature of gas, K
- $T_2$  = final temperature of gas (in this case, 298 K)
- $P_1$  = initial pressure of gas, mm Hg
- $P_2$  = final pressure of gas (in this case, 760 mm Hg)

$$V_c = V_{meas} \left( \frac{P_b - P_w}{P_b} \right)$$

Where:  $V_c$  = corrected volume

$V_{meas}$  = measured volume

$P_b$  = atmospheric pressure, mm Hg

$P_w$  = vapor pressure of water at the room temperature, mm Hg.

# Volume Meters

## Frictionless Pistons - Primary Standard



TEMPERATURE (C°)	VAPOR PRESSURE (TORR)
15° C	12.8
16° C	13.6
17° C	14.5
18° C	15.5
19° C	16.5
20° C	17.6
21° C	18.7
22° C	19.8
23° C	21.1
24° C	22.4
25° C	23.8
26° C	25.2
27° C	26.8
28° C	28.4
29° C	30.1
30° C	31.9

Vapor pressure table.<sup>[1]</sup>

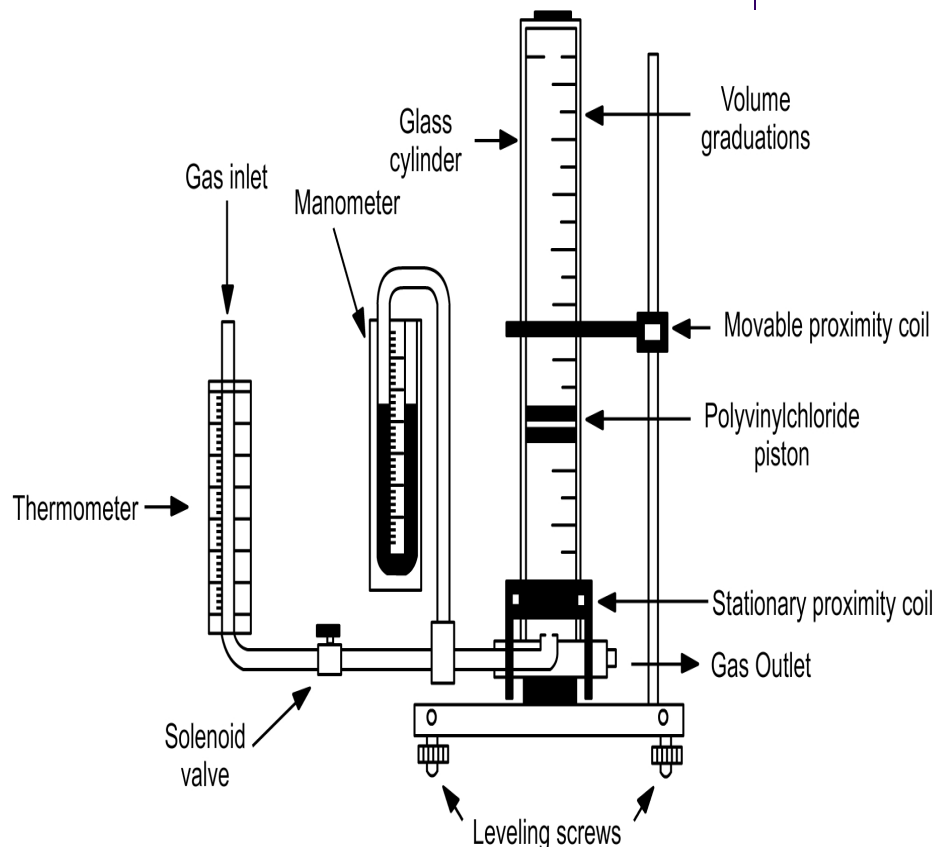

Mercury-sealed piston volume meter

# Volume Meters

## Automated Bubble Flowmeters

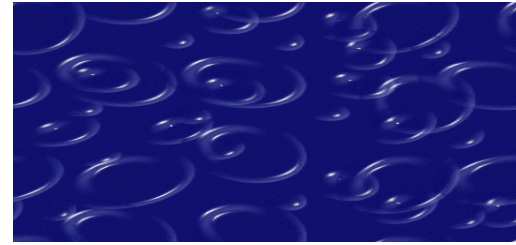

- Easier to use than the manual version and likely to provide more uniform and accurate flow rate measurements.

## Automated Dry-Piston Flowmeters

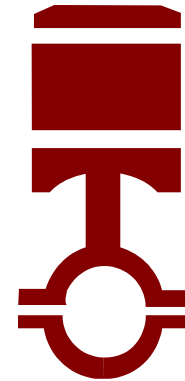

- Similar to soap-bubble flowmeters except they use a lightweight, low-friction, rigid piston in place of the soap-bubble.



# Volume Meters

## Wet Test Meter (WTM) - Secondary Standard

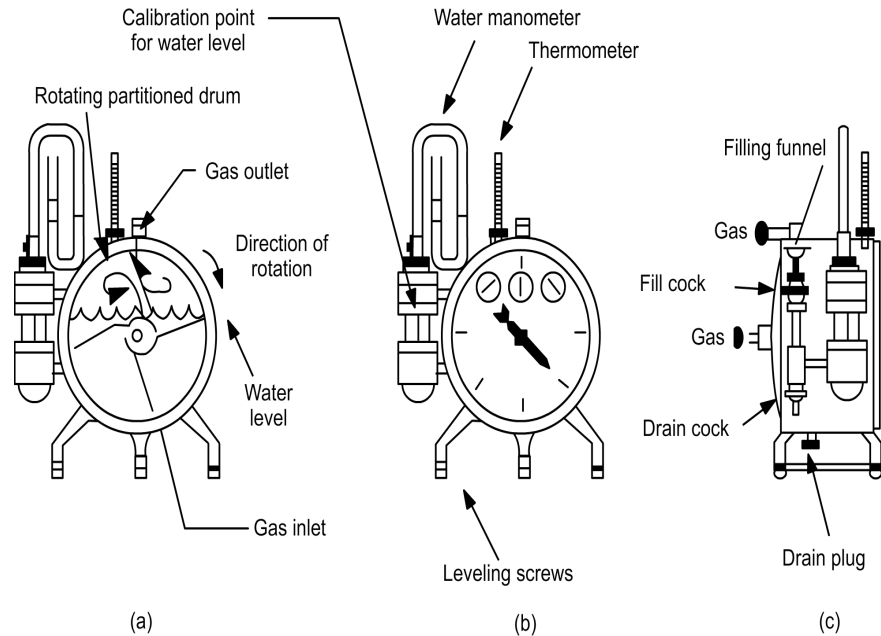

Wet test meter

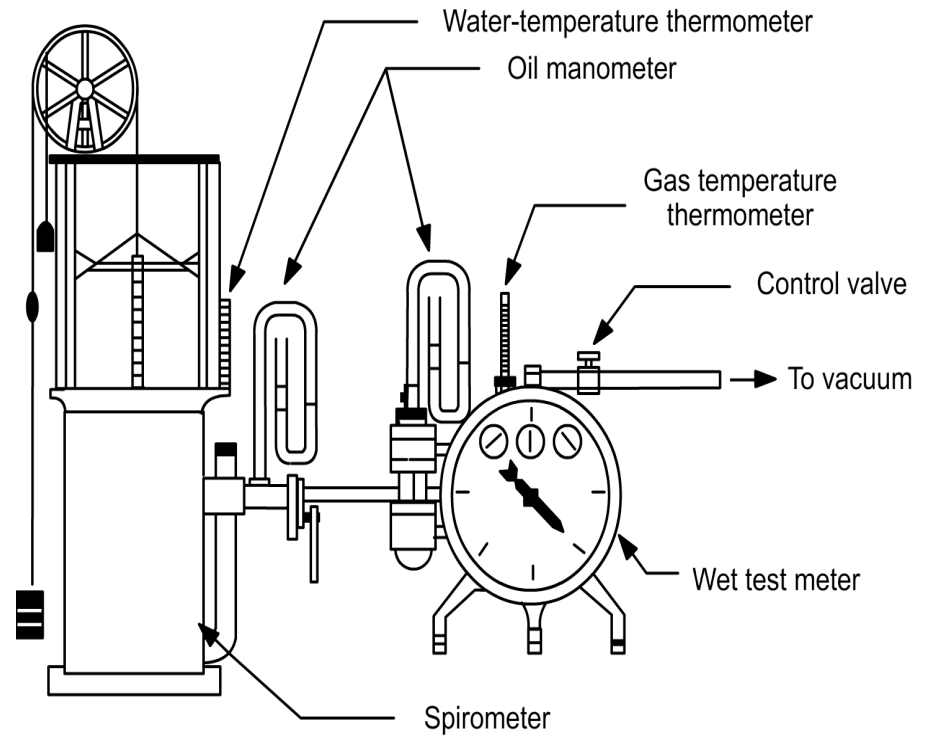

Setup for calibrating a wet test meter against a spirometer

# Volume Meters

## Wet Test Meter (WTM) - Secondary Standard



$$V_c = V_{meas} \left( \frac{P_b - P_w}{P_b} \right)$$

Where:

$V_c$  = corrected volume ( $V_2$ )

$V_{meas}$  = measured volume ( $V_1$ )

$P_b$  = atmospheric pressure, mm Hg

$P_w$  = vapor pressure of water at the room temperature, mm Hg

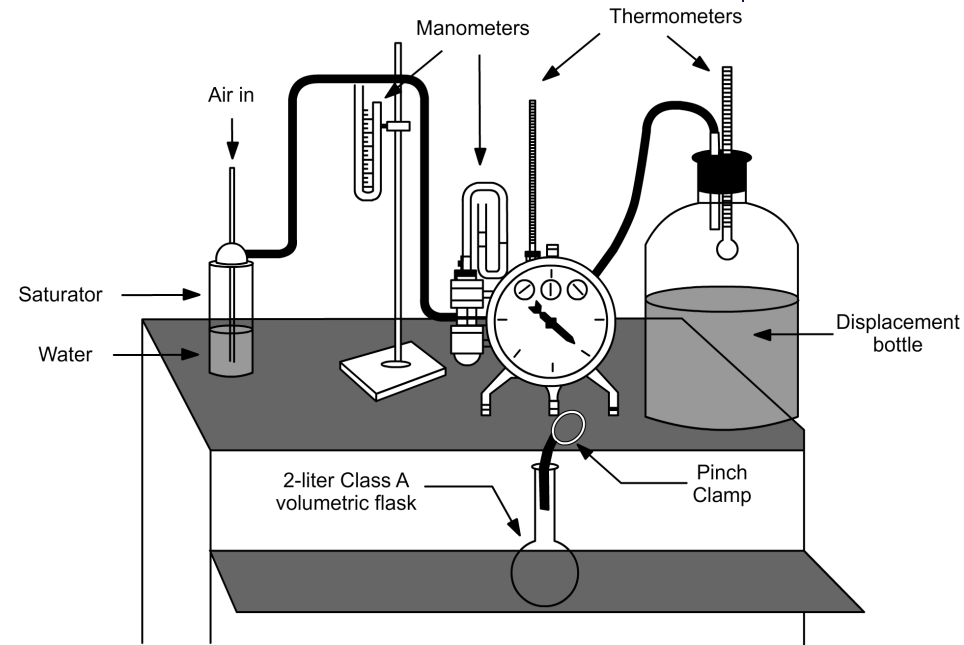

Calibration of wet test meter with displacement bottle

# Volume Meters

## Roots Meter - Secondary Standard

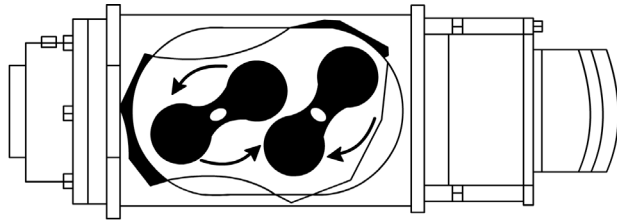

Position 1

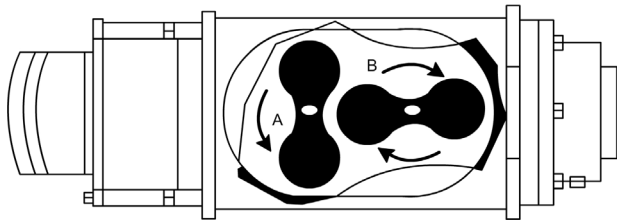

Position 2

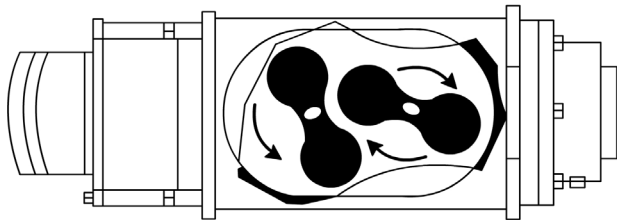

Position 3

$$V_2 = V_1 \left( \frac{P_1}{760 \text{ mm Hg}} \right) \left( \frac{298 \text{ K}}{T_2} \right)$$

Where:

$V_2$  = volume of gas at 2nd conditions or at  $P_2$  and  $T_2$

$V_1$  = a volume of gas at 1st conditions of  $P_1$  and  $T_1$

$T_1$  = initial temperature of gas, K

$T_2$  = final temperature of gas (in this case, 298 K)

$P_1$  = initial pressure of gas, mm Hg

$P_2$  = final pressure of gas (in this case, 760 mm Hg)

$$P_1 = P_b - \Delta p$$

Principle of gas flow through the Roots meter

# Volume Meters

## Dry Test Meter - Secondary Standard

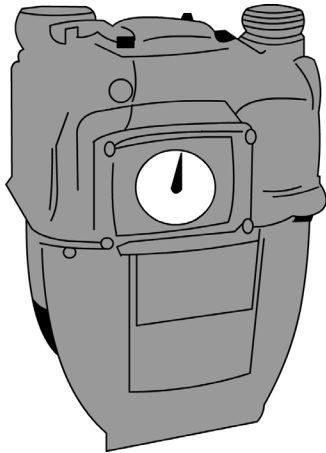

Dry gas meter

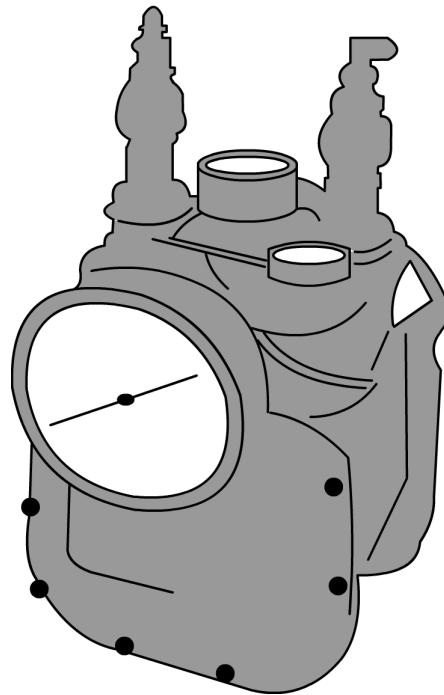

Dry test meter

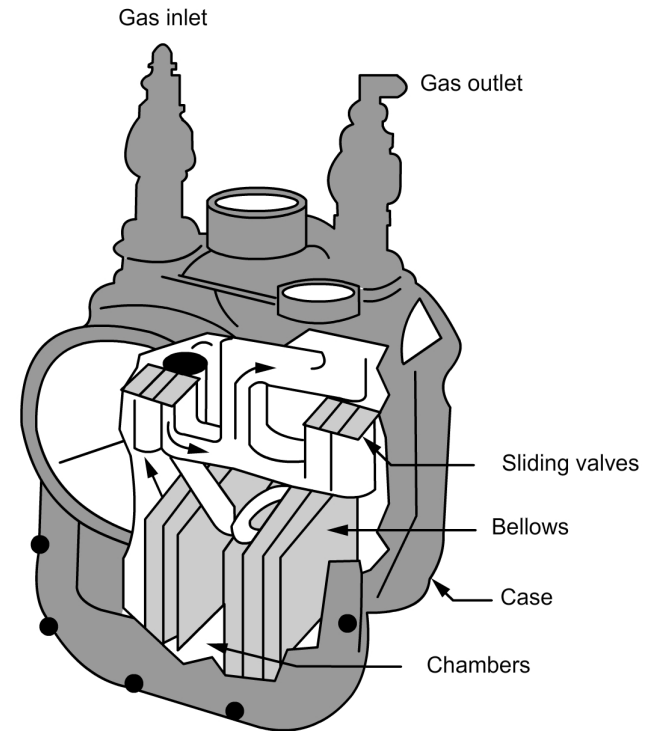

# Volume Meters

## Dry Test Meter - Secondary Standard

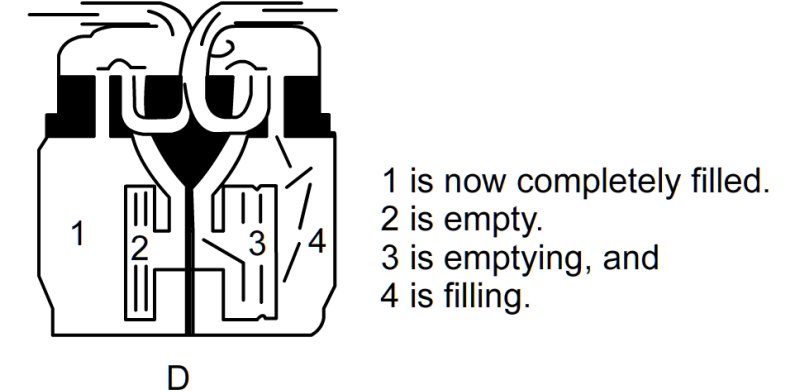
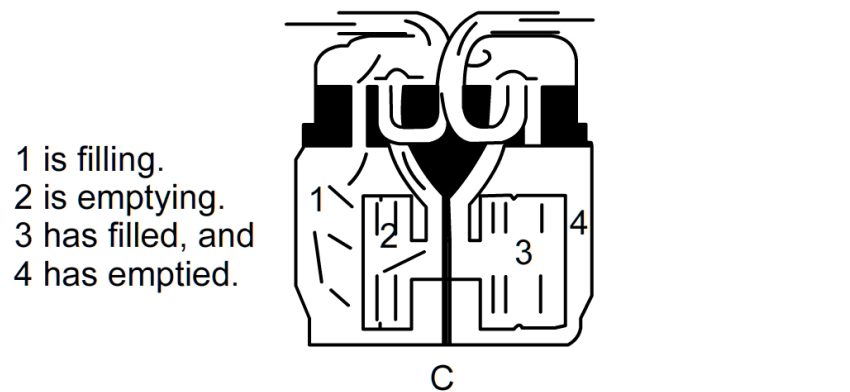
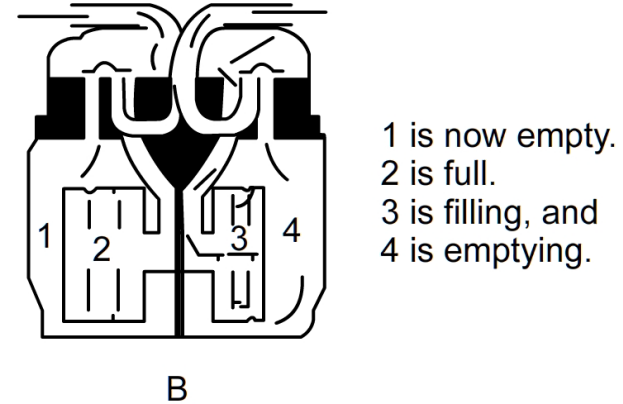
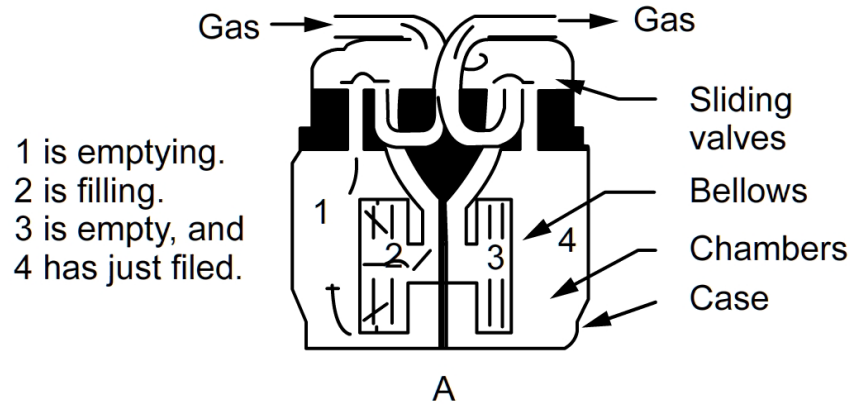

Working mechanism of dry test meter

# Rate Meters

## Variable-Pressure Meters - Head Meters

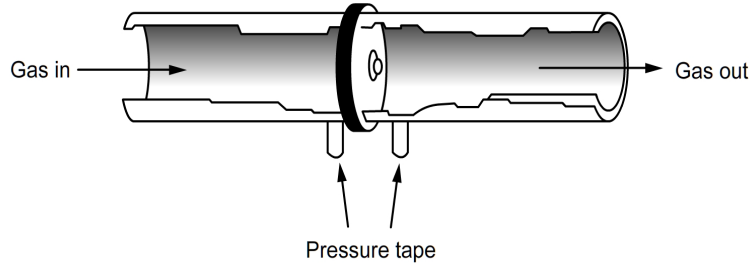

Orifice meter.

$$Q_2 = Q_1 \left( \frac{P_1 \times T_2}{P_2 \times T_1} \right)$$

Where:

$Q$  = flow

$P$  = pressure

$T$  = temperature in K

1 = initial conditions

2 = final conditions

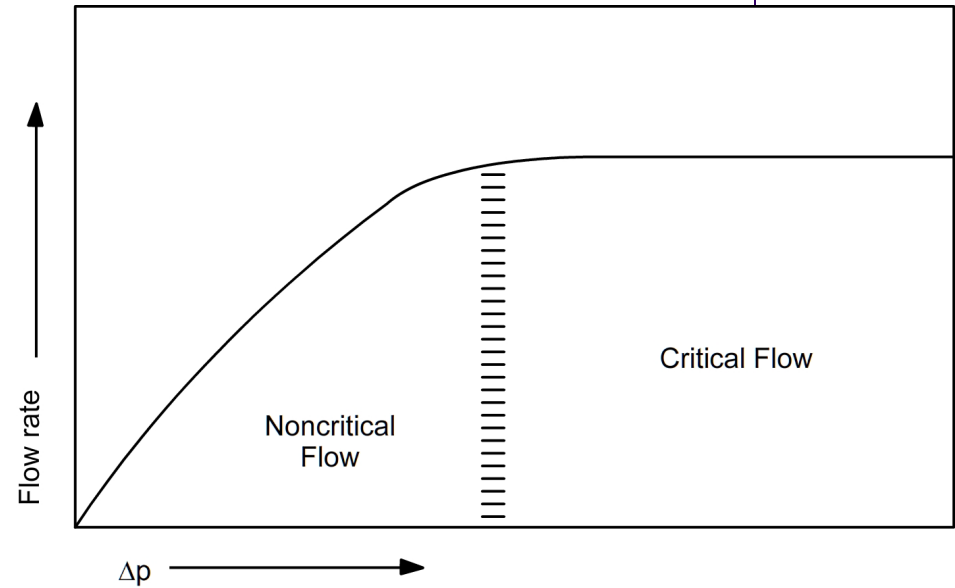

Typical orifice meter calibration curve

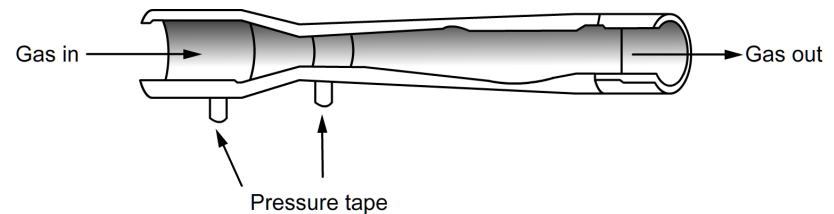

Venturi meter

# Rate Meters

## Variable Area Meters

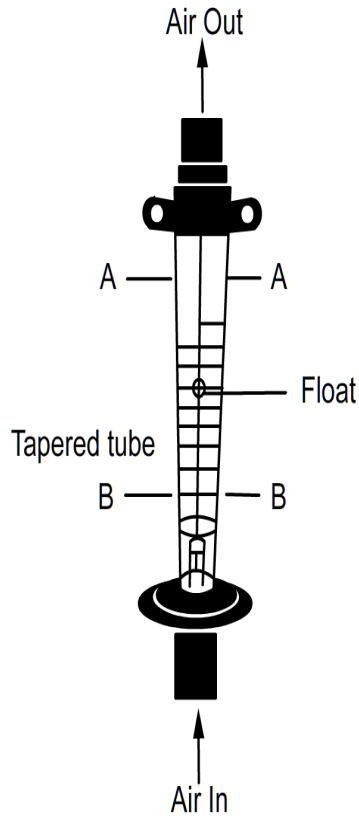

Rotameter

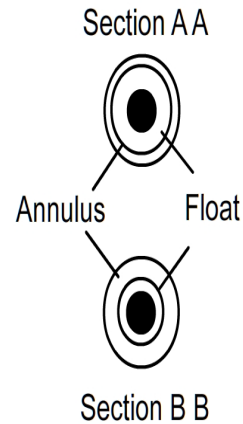

$$Q_2 = Q_1 \left( \frac{P_1 \times T_2}{P_2 \times T_1} \right)$$

Where:  $Q$  = flow  
 $P$  = pressure  
 $T$  = temperature in K  
 1 = initial conditions  
 2 = final conditions

$$Q_1 = Q_2 \left( \frac{q_2}{q_1} \right)^{1/2}$$

Where:  $Q_1$  = flow rate with gas 1  
 $Q_2$  = flow rate with gas 2  
 $q_2$  = density of gas 2  
 $q_1$  = density of gas 1

# Rate Meters

## Mass Flow Meters – Heat Transfer Meters –

### “Hot-Wire” Meters

- Operate on the principle that when a gas passes over a heated surface, heat is transferred from the surface to the gas
- Two basic applications: mass flow meters (measures volumetric flow rate) and mass flow controllers (measures and controls volumetric flow rate)

$$GCF = \frac{C_{pN_2}}{C_{pgasx}}$$

Where:

$GCF$	=	gas correction factor
$C_{pN_2}$	=	molar specific heat for $N_2$ gas (the typical gas used to calibrate a MFM)
$C_{pgasx}$	=	molar specific heat for the sample gas





# Velocity Meters

-Measure the linear velocity or some property that is proportional to the velocity of a gas

$$Q = A\bar{v}$$

Where:  $Q$  = volumetric flow rate,  $m^3/min$

$\bar{v}$  = average velocity,  $m/min$

$A$  = cross sectional area,  $m^2$



# Velocity Meters

## Pitot Tube – Primary Velocity Standard

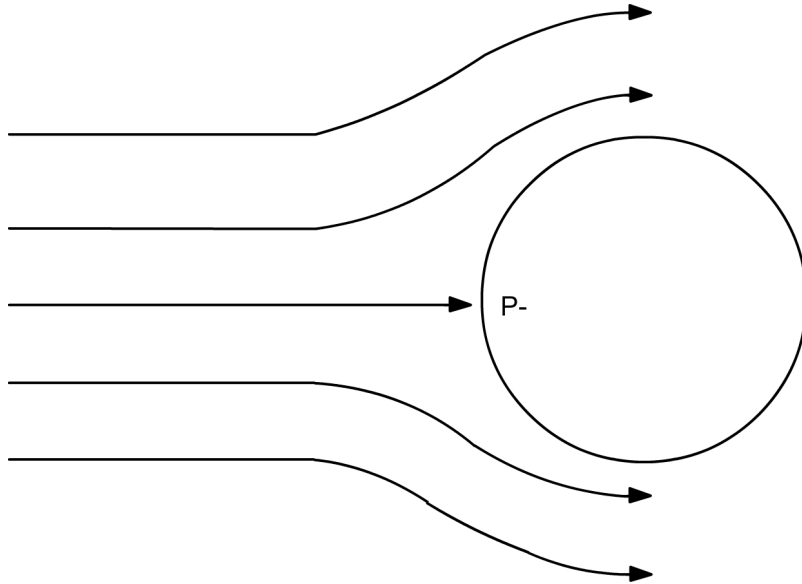

Gas stagnation against an object

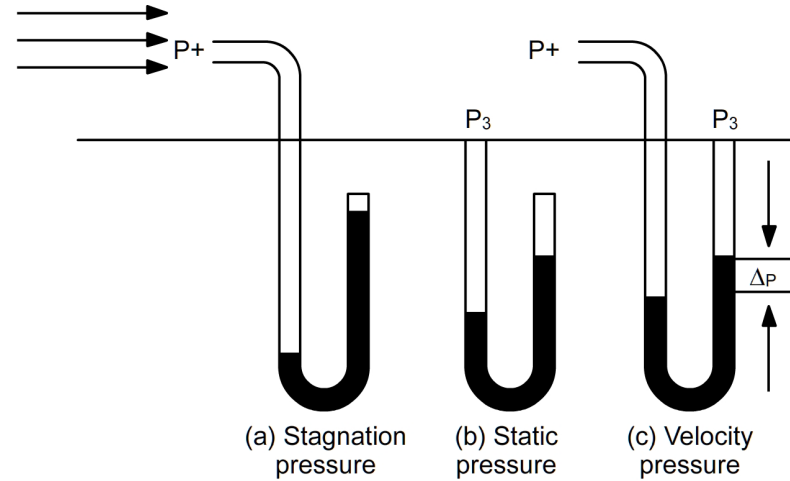

Pitot tube pressure components

$$v = K_p C_p \left( \frac{T \Delta p}{P M} \right)^{1/2}$$

Where:  $v$  = velocity of the gas stream, ft/sec

$T$  = absolute temperature, R ( $^{\circ}\text{F} + 460$ )

$P$  = absolute pressure, in. Hg

$M$  = molecular weight of the gas, lb/lb-mole

$\Delta p$  = velocity pressure, in. H<sub>2</sub>O

$$K_p = 85.49 \text{ ft/sec} \sqrt{\frac{(\text{lb/lb} \cdot \text{mole})(\text{in. Hg})}{(\text{in. H}_2\text{O})(^{\circ}\text{R})}}$$

$C_p$  = pitot tube coefficient, dimensionless.

# Velocity Meters

## Standard Pitot Tube – Secondary Velocity Standard

$$v = K_p C_p \left( \frac{T \Delta p}{P M} \right)^{1/2}$$

Where:

$v$  = velocity of the gas stream, ft/sec

$T$  = absolute temperature, R ( $^{\circ}\text{F} + 460$ )

$P$  = absolute pressure, in. Hg

$M$  = molecular weight of the gas, lb/lb-mole

$\Delta p$  = velocity pressure, in. H<sub>2</sub>O

$$K_p = 85.49 \text{ ft/sec} \sqrt{\frac{(\text{lb/lb} \cdot \text{mole})(\text{in. Hg})}{(\text{in. H}_2\text{O})(^{\circ}\text{R})}}$$

$C_p$  = pitot tube coefficient, dimensionless

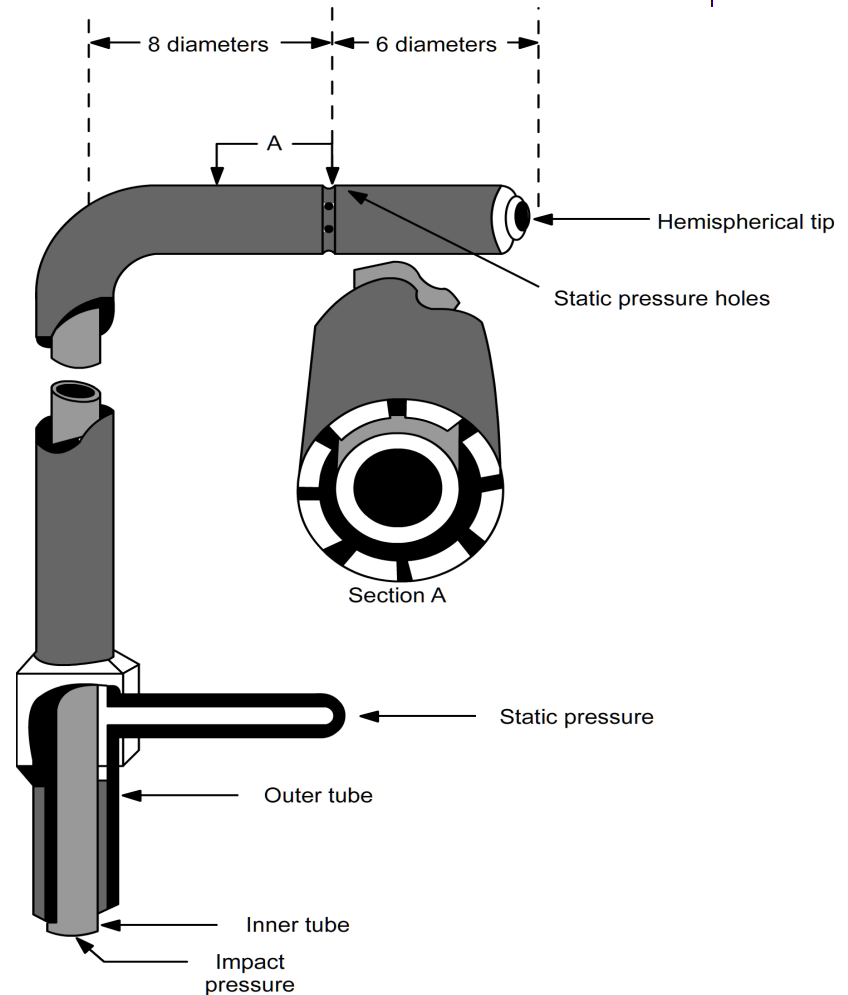

Standard pitot tube

# Velocity Meters

## S-Type Pitot Tube – Secondary Velocity Standard

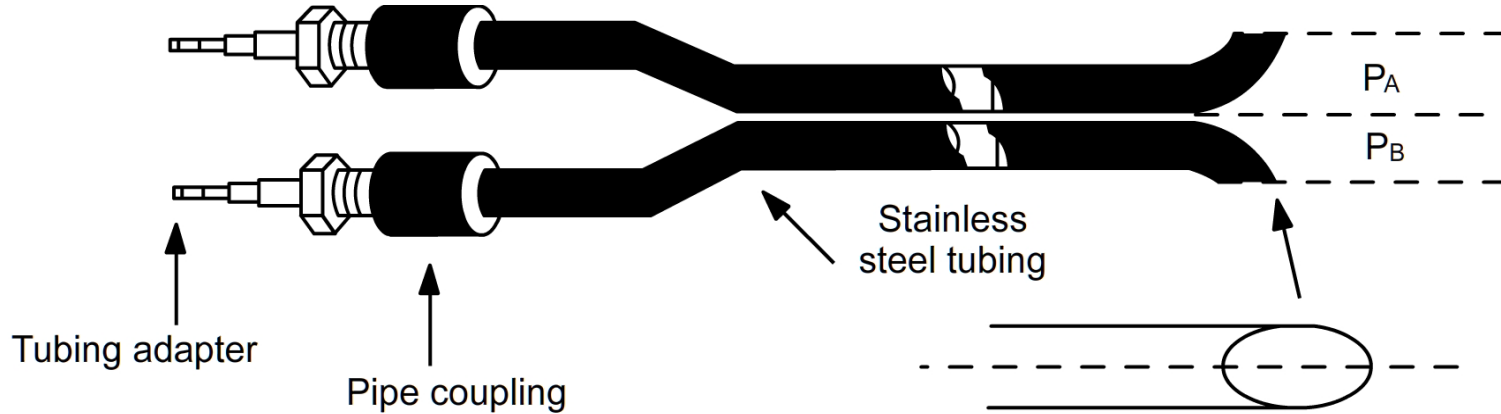

S-type pitot tube

$$C_{p(S)} = C_{p(STD)} \left( \frac{\Delta p_{STD}}{\Delta p_s} \right)$$

Where:

$C_{p(S)}$  = S-Type Pitot tube coefficient

$C_{p(STD)}$  = Standard pitot tube coefficient

$\Delta p_{STD}$  = velocity pressure of Standard pitot tube, in. H<sub>2</sub>O

$\Delta p_s$  = velocity pressure of S-Type pitot tube, in. H<sub>2</sub>O

$$v = K_p C_p \left( \frac{T \Delta p}{P M} \right)^{1/2}$$

Where:

$v$  = velocity of the gas stream, ft/sec

$T$  = absolute temperature, R ( $^{\circ}\text{F} + 460$ )

$P$  = absolute pressure, in. Hg

$M$  = molecular weight of the gas, lb/lb-mole

$\Delta p$  = velocity pressure, in. H<sub>2</sub>O

$$K_p = 85.49 \text{ ft/sec} \sqrt{\frac{(\text{lb/lb} \cdot \text{mole})(\text{in. Hg})}{(\text{in. H}_2\text{O})(^{\circ}\text{R})}}$$

$C_p$  = pitot tube coefficient, dimensionless

# Velocity Meters

## Thermal Anemometer – Secondary Velocity Standard



- Measures fluid velocities by measuring heat transfer from a small wire or film held in the gas stream of a stack or duct or in the ambient air to measure wind speed
- Typically used in source sampling applications to determine the velocity of a gas within a stack or duct

### Advantages

- High accuracy
- Easily-automated collection procedure
- High frequency response allowing measurement of turbulent flows



# Sample Problems

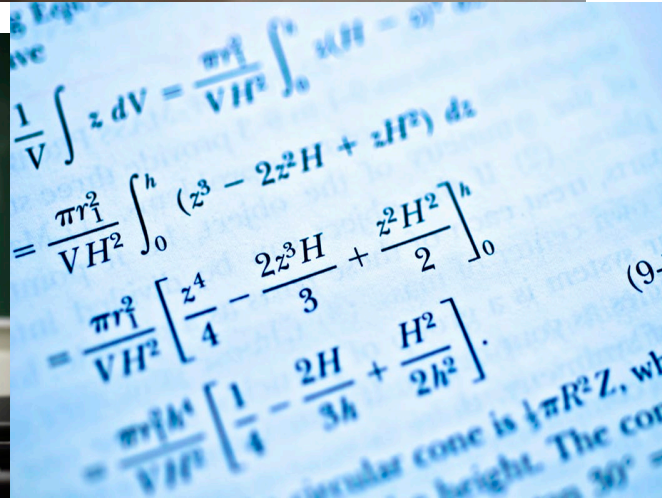
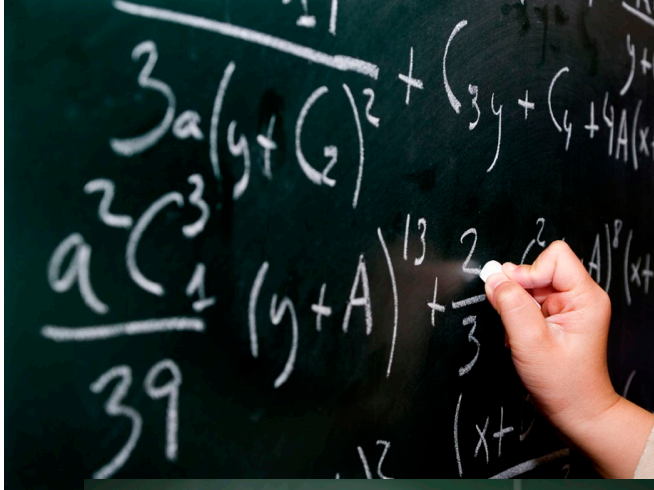

# Additional PM2.5 Flowmeters and Devices

- Bubble Flowmeters
- Piston Flowmeters
- Mass Flowmeters
- Orifice Devices
- Laminar Flow Elements
- Wet Test Meters
- Dry Gas Meters

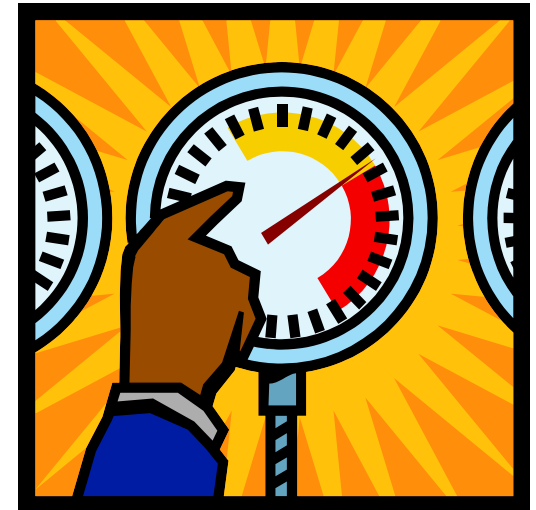
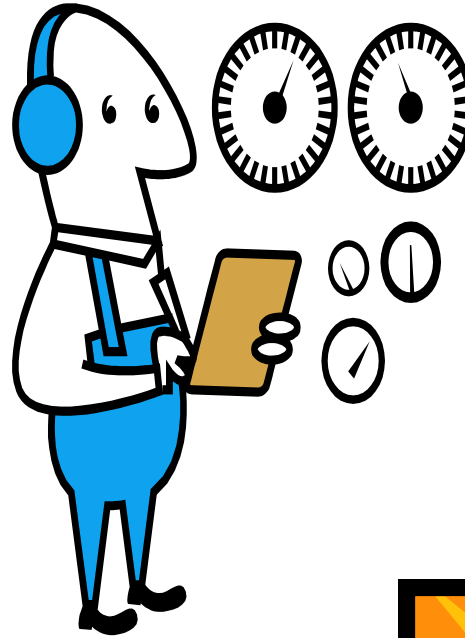

# APTI 435: Atmospheric Sampling Course Chapter 3



Questions?



Summary



# Chapter 4

## Particulate Matter Sampling



---

APTI 435: Atmospheric Sampling Course



# Terminal Learning Objective

- At the end of this chapter, the student will be able to identify the procedures of particulate matter sampling.



# Enabling Learning Objectives

- 4.1- View the principle of inertial collection
- 4.2- Identify and classify the inertial sampling devices
- 4.3- View collection efficiency and penetration efficiency of inertial sampling devices
- 4.4- Identify limitations and sources of error in inertial collection
- 4.5- View filtration sampling
- 4.6- View gravitational sampling
- 4.7- Describe the principles and applications of electrostatic precipitation
- 4.8- Describe the thermal precipitators
- 4.9- Summarize the fundamental principles for sampling for PM in the atmosphere

# Introduction to Particulate Matter Sampling

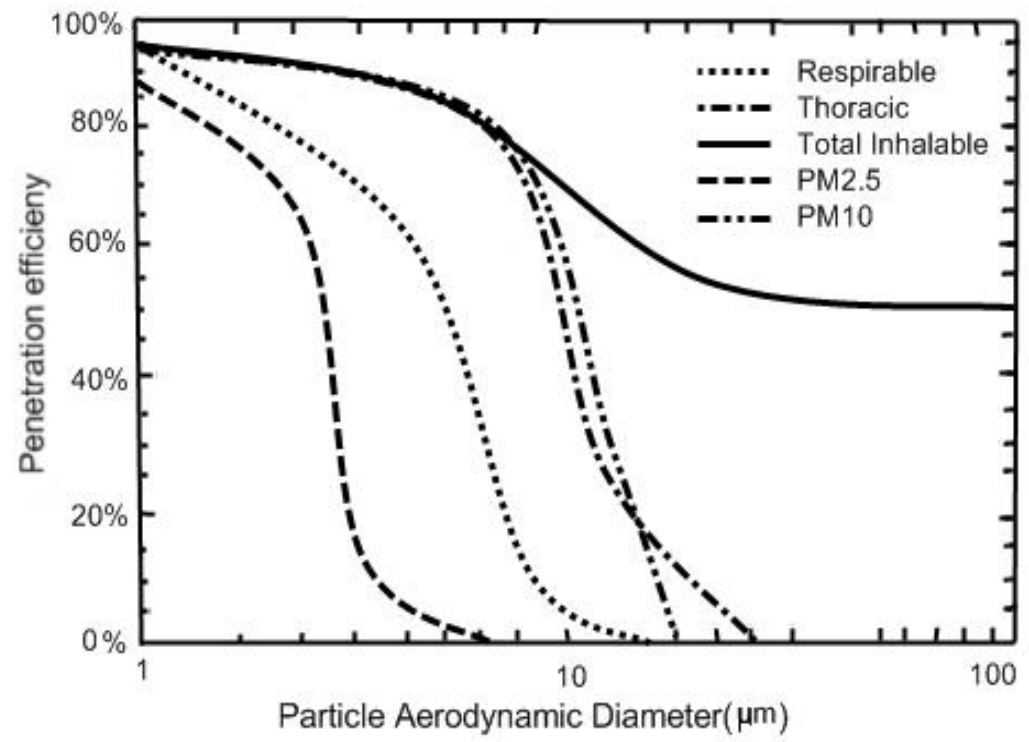
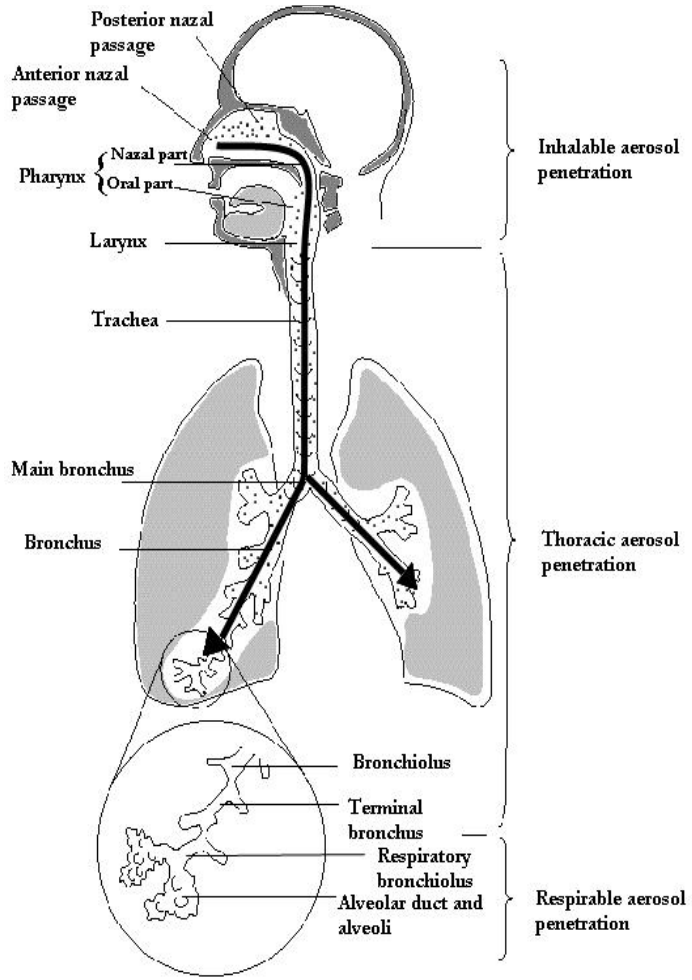

Respiratory collection of particles

Modeled lung deposition as a function of particle size

# Introduction to Particulate Matter Sampling

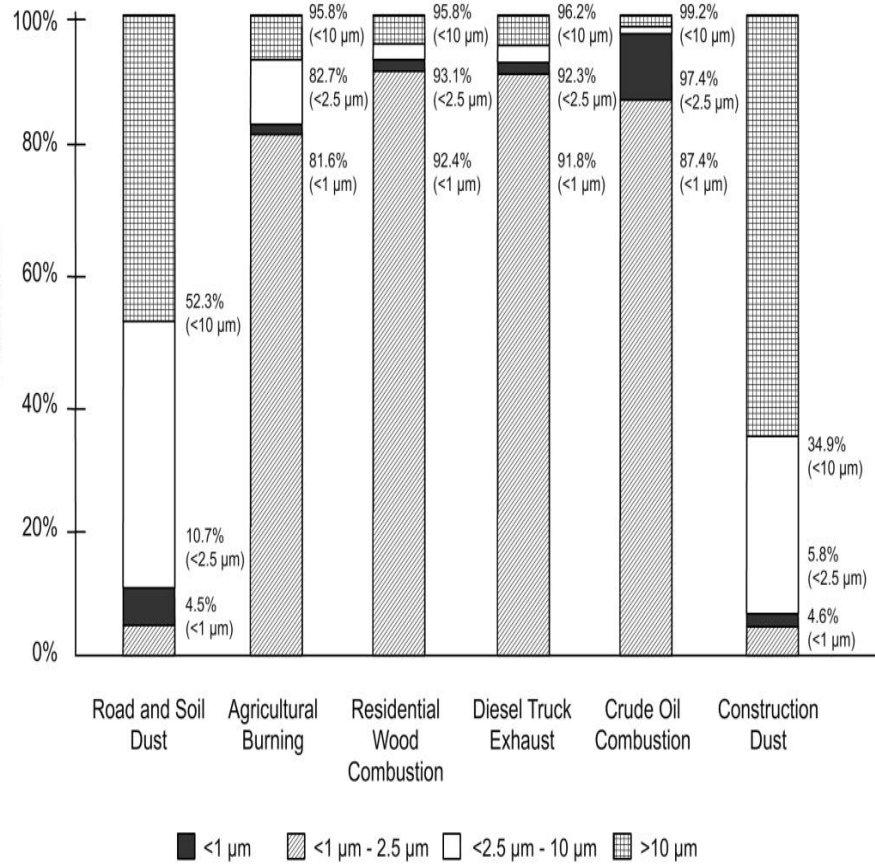

**Particle size distributions of sources of particulate emissions**

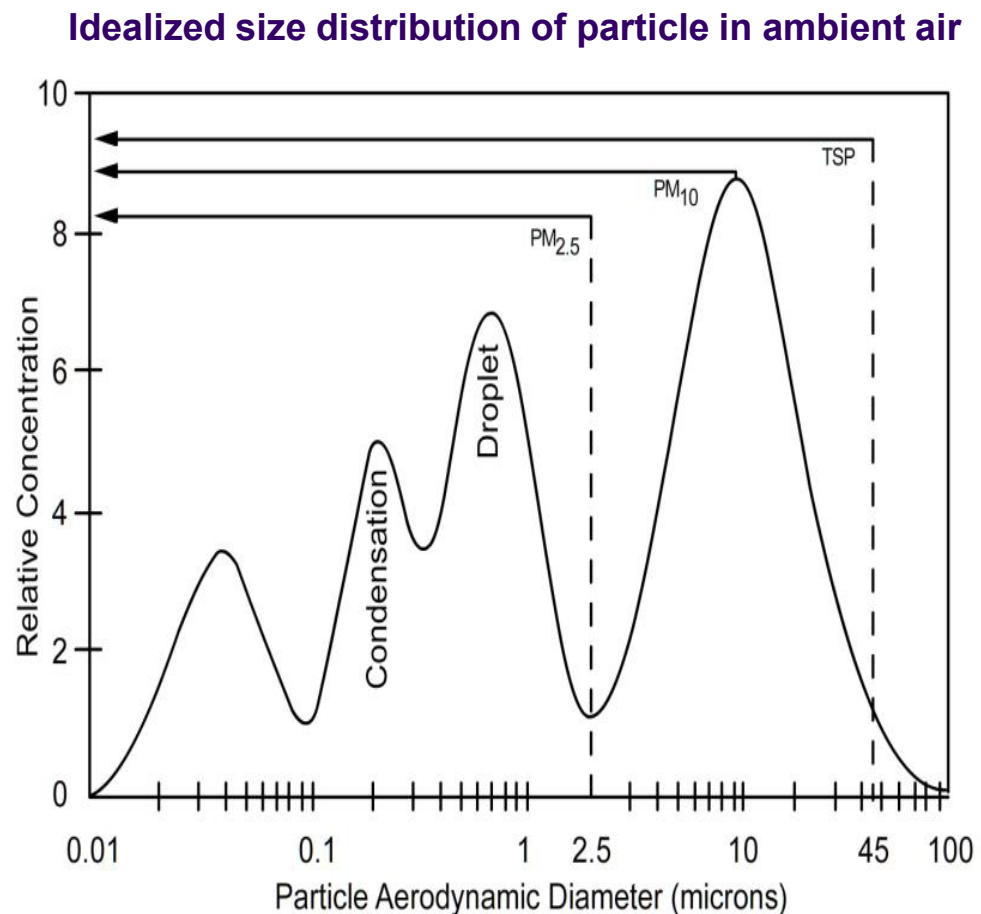

# Introduction to Particulate Matter Sampling

## Principles of Inertial Collection



- In addition to the size and nature of the particles, other important aspects to consider include;

- Theory of inertial impaction
- Particle settling
- Effects of thermal and electrical forces
- Theory of filtration

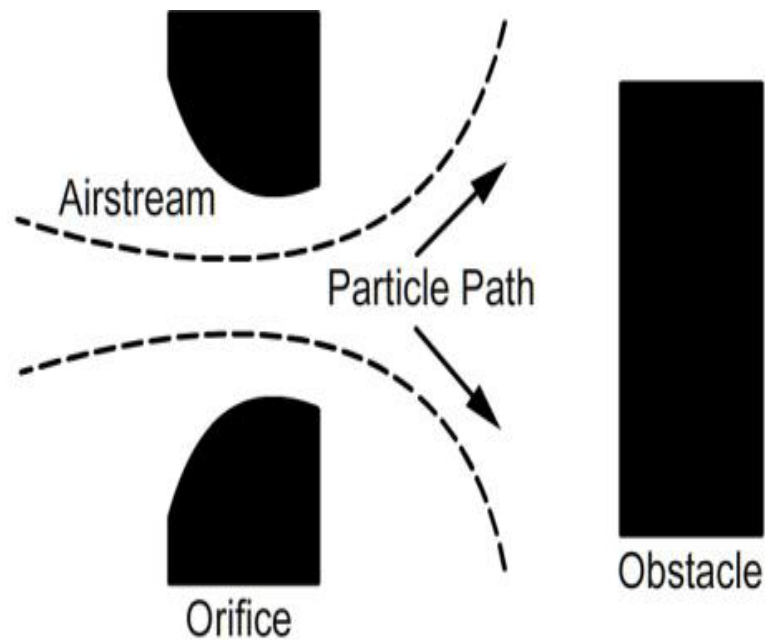

**Particle collection by impaction**

# Inertial Sampling Devices

## Impaction Devices

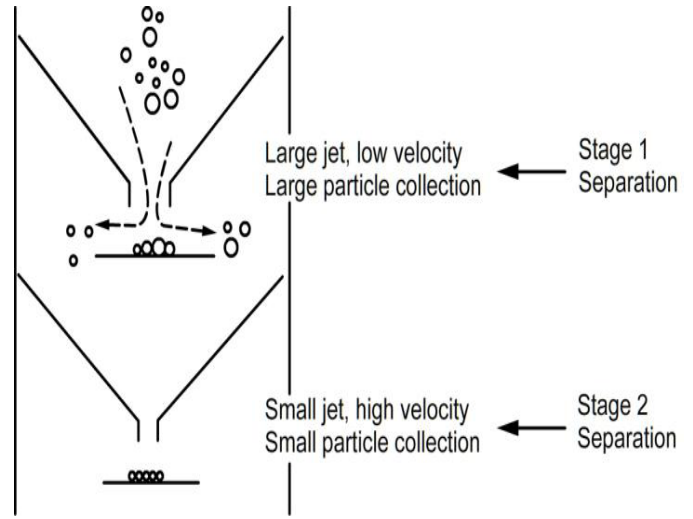

**Two-stage impactor**

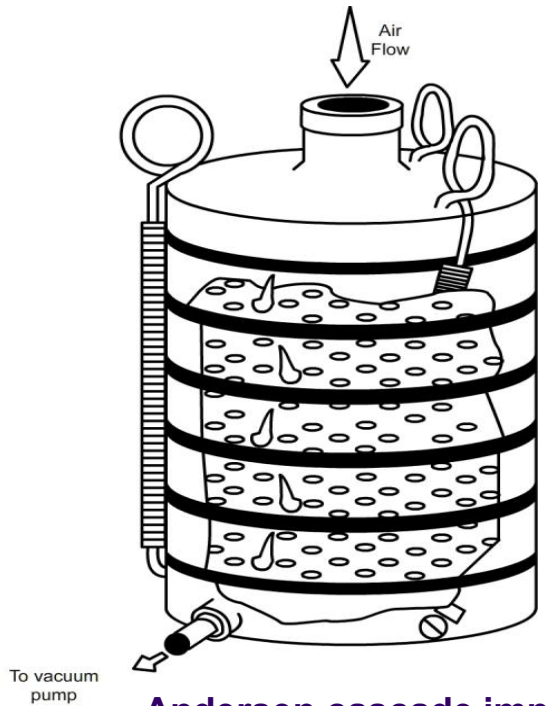

**Andersen cascade impactor**

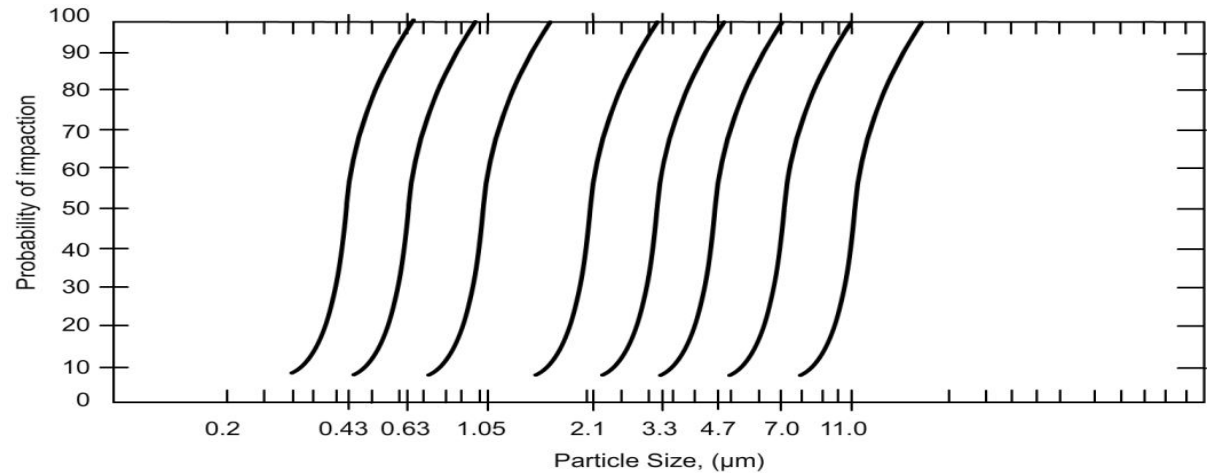

**Collection efficiency of each of 8 stages of an Andersen cascade impactor operated at 1 cfm.**

# Inertial Sampling Devices

## Impaction Devices

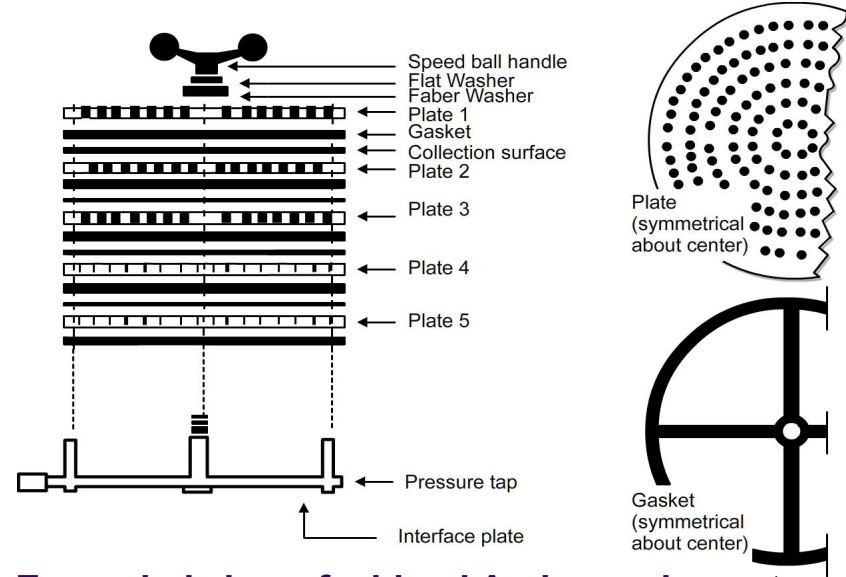
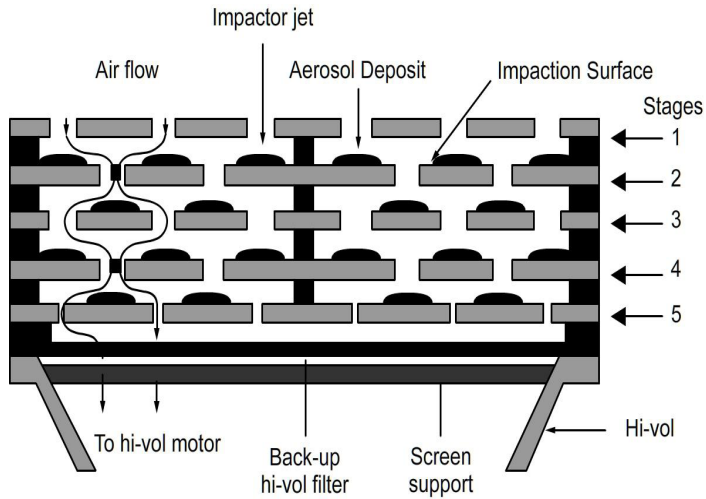

**Cross-sectional view of a hi-vol Andersen impactor**

**Expanded view of a hi-vol Andersen impactor**

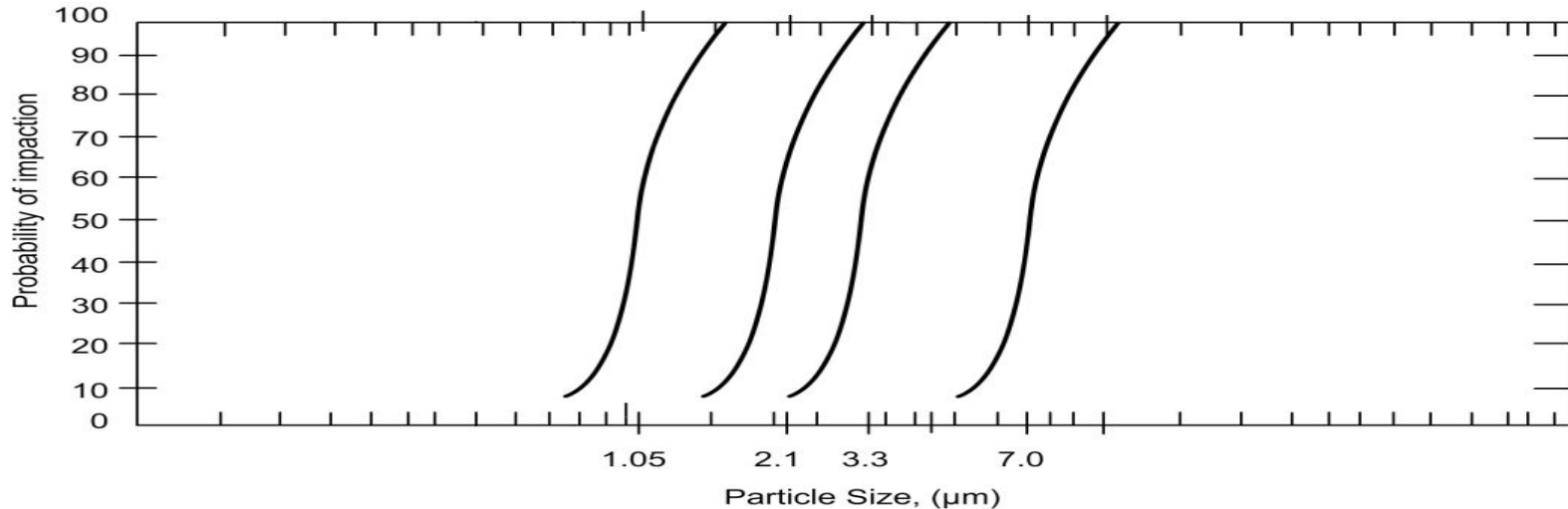

**Collection efficiency of a hi-vol Andersen impactor operated at 20 cfm**



# Inertial Sampling Devices

## Impaction Devices

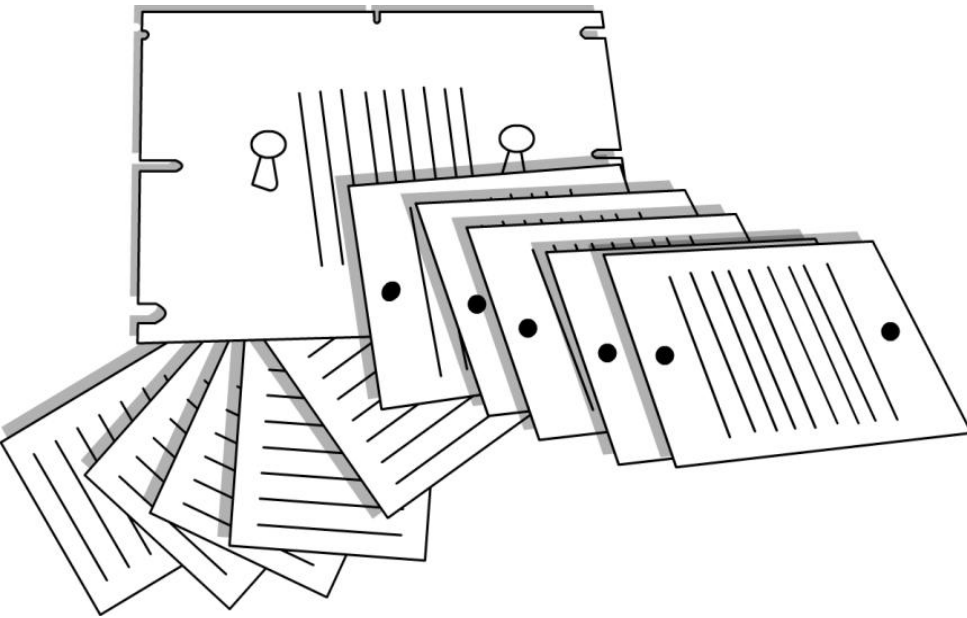

**Multiple-slit high-volume cascade impactor**

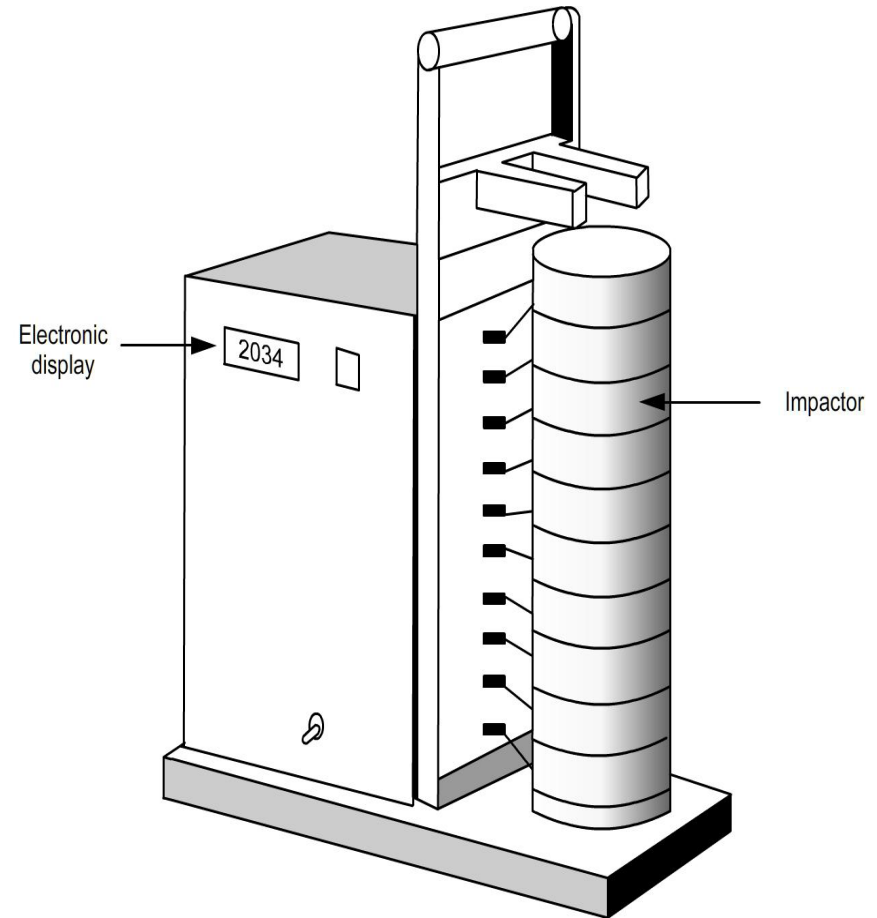

**Quartz crystal cascade impactor**

# Inertial Sampling Devices

## Impaction Devices

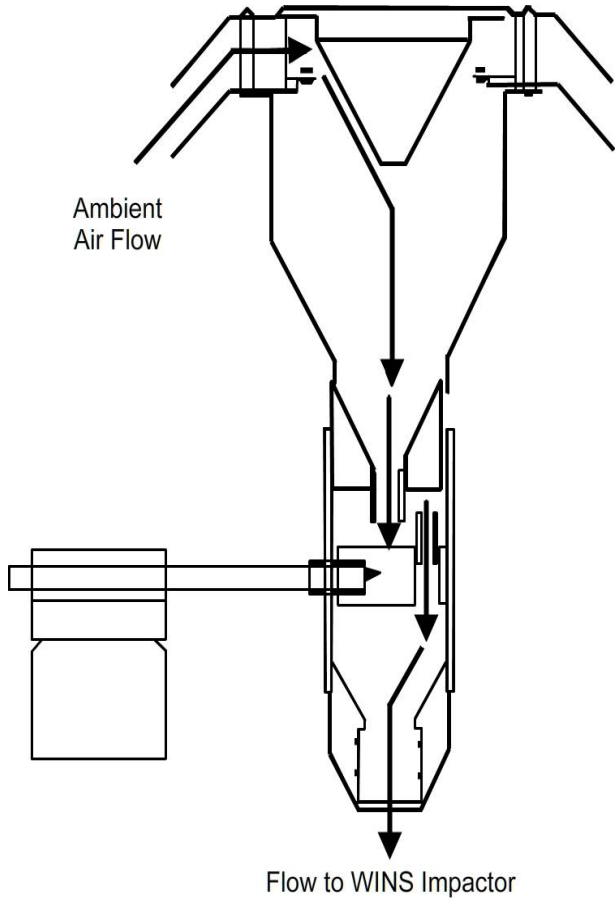

**Inlet of PM<sub>2.5</sub> inertial particle size separator**

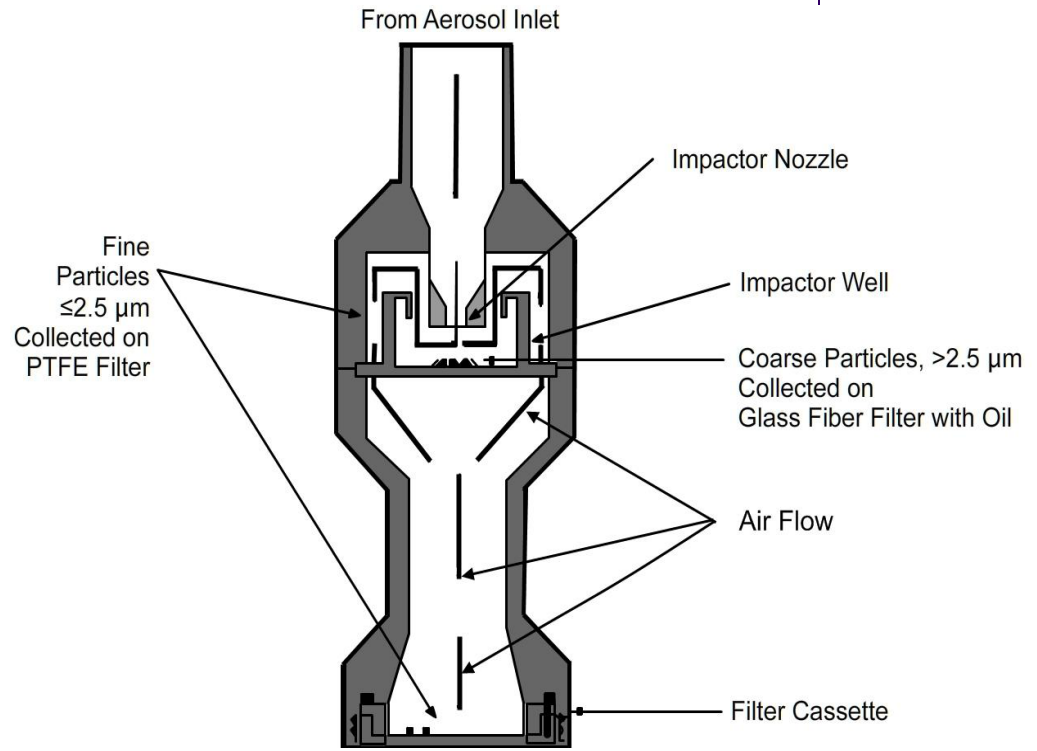

**WINS particle impactor and filter holder assembly**

# Inertial Sampling Devices

## Impingement Devices



- Differ from impactors because the jet and striking surface are immersed in a collection fluid
- Most impingers in use are variations of the instrument developed by Greenburg and Smith (Balzer 1972)
- Most commonly used in collecting dusts, mists, and fumes in the evaluation of occupational health hazards



# Inertial Sampling Devices

## Centrifugal Separation Devices

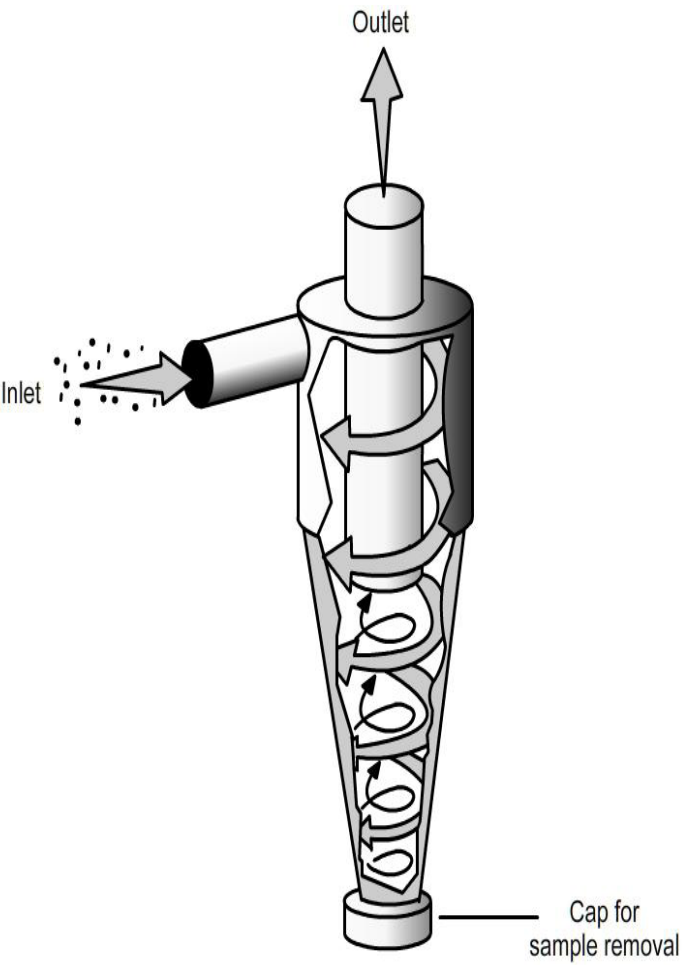

Cyclone sampler

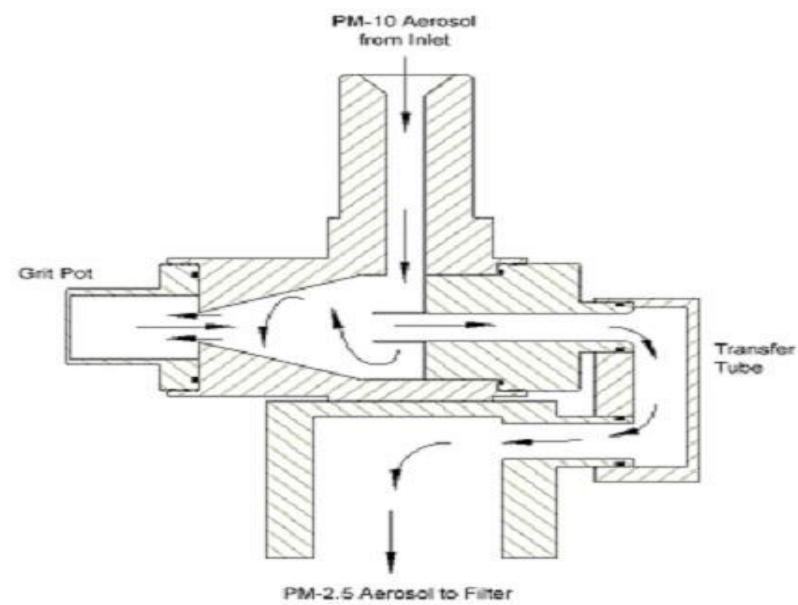

Flow schematic of VSCC PM2.5 fractionator

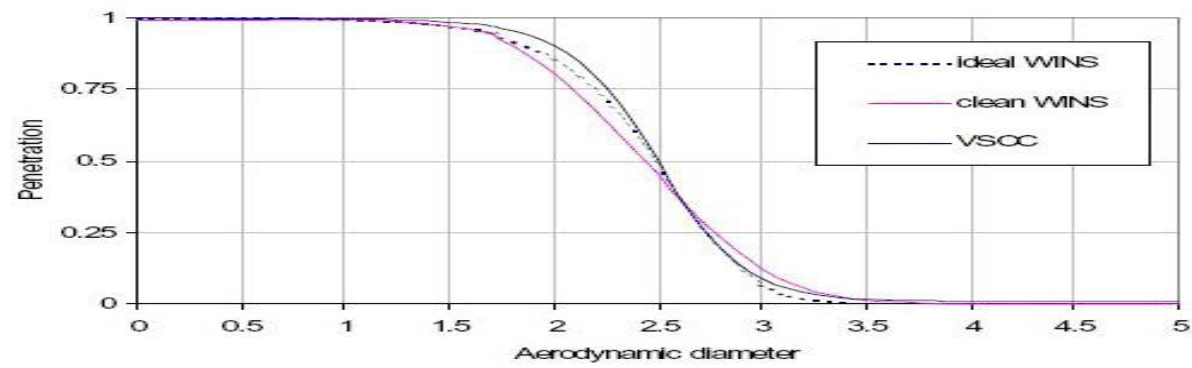

Penetration efficiency of VSCC PM2.5 fractionator and WINS PM2.5 impactor

# Inertial Sampling Devices

## Virtual Impactors—Dichotomous Sampler

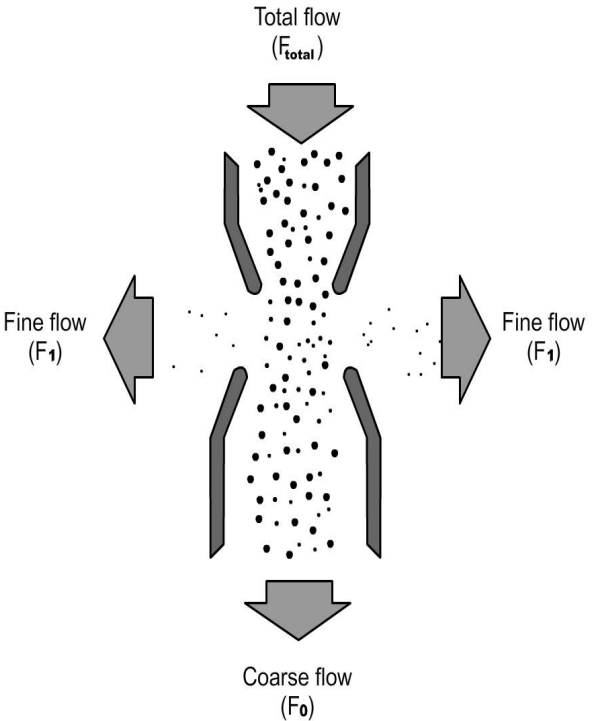

Schematic of virtual impactor

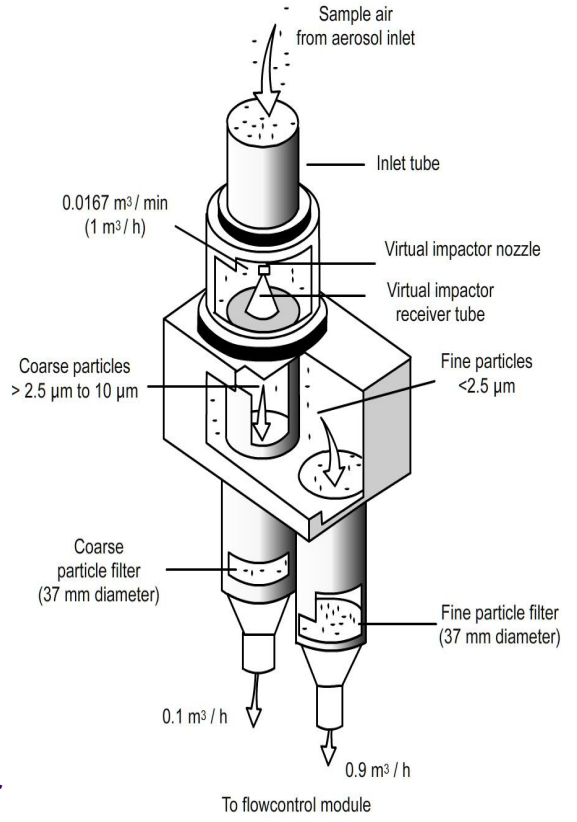
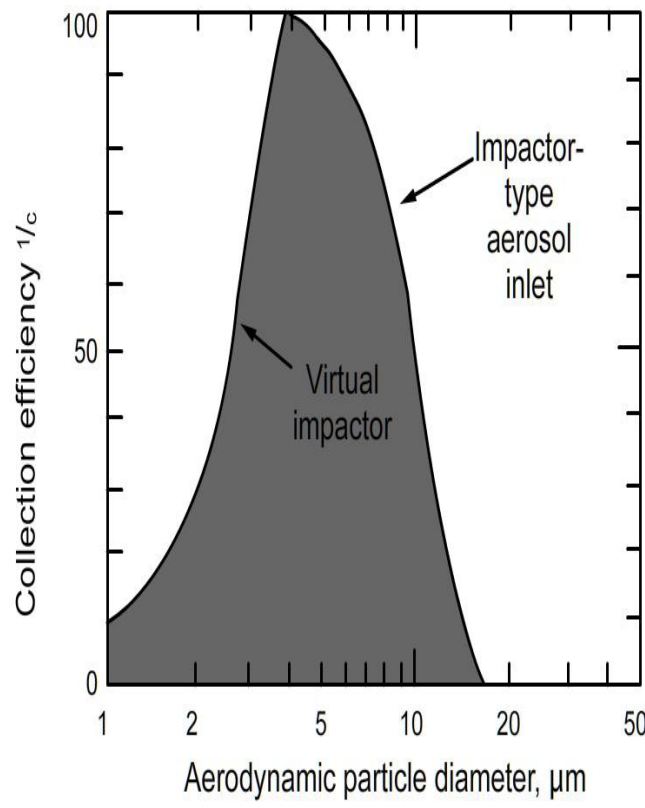

Diagram of the sampling module of a dichotomous sampler



Collection efficiencies for a dichotomous sampler

# Inertial Sampling Devices

## Virtual Impactors—Dichotomous Sampler

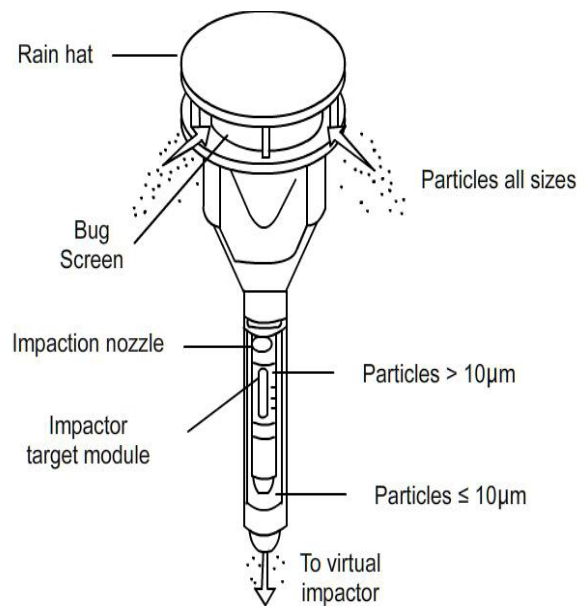

Impactor-type aerosol inlet for dichotomous sampler

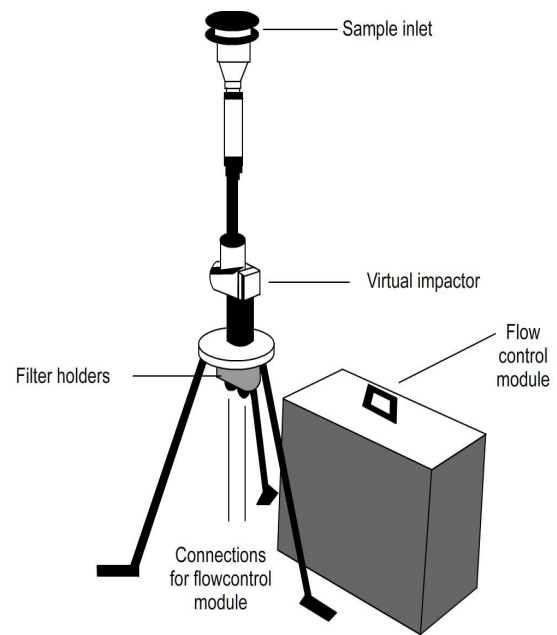

Dichotomous sampler

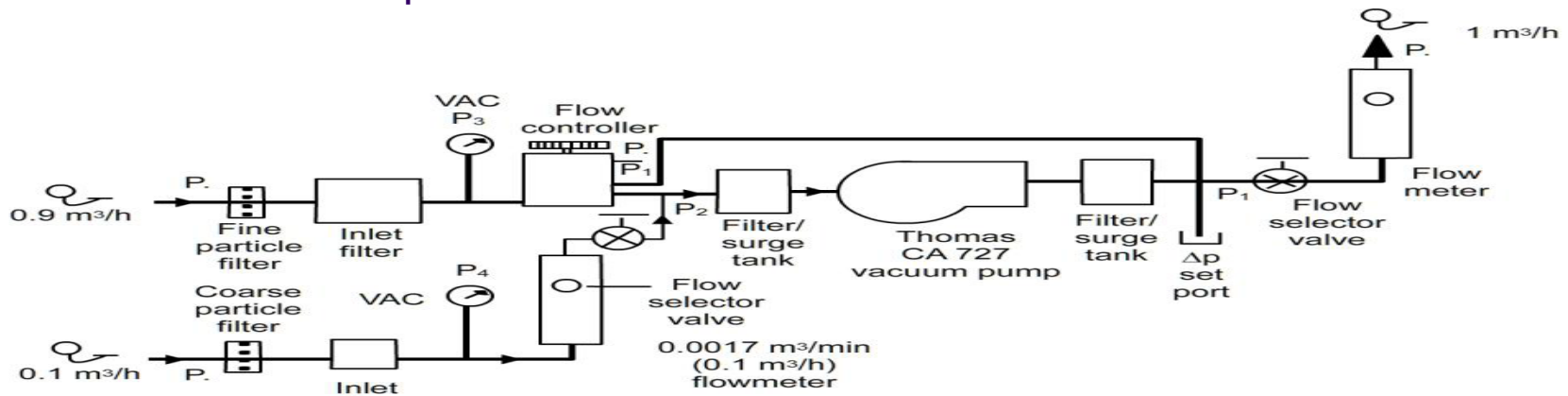

Flow schematic of dichotomous sampler

# Collection Efficiency and Penetration Efficiency of Inertial Sampling Devices



## Definition of Collection Efficiency and Penetration Efficiency

- The ratio of the number of particles striking an obstacle to the number that would strike if the stream lines were not deflected.

Collection efficiency - The fraction of the particles in an incident aerosol stream that is retained on the collection surface of the sampling device

Penetration efficiency - The fraction of the particles in an incident aerosol stream that passes through the collection surface of the sampling device



# Collection Efficiency and Penetration Efficiency of Inertial Sampling Devices

## Impactor Performance Characteristics

- Efficiency plotted against particle size for a given device

## Properties of Aerosols Affecting Inertial Collection Efficiency

- Particle Size
- Particle Density
- Aerosol Fluid Density

## Properties of the Collecting Device Influencing Collection Efficiency

- Jet Size
- Jet Shape
- Jet to Collection Distance
- Collection Surface

$$v = Q/A$$

Where:  $v$  = air velocity  
 $Q$  = volumetric flow rate  
 $A$  = cross-sectional area of the air stream



# Limitations and Sources of Error in Inertial Collection



## Inherent Errors in Sample Collection

- Particle Shattering
- Particle Bounce, Reentrainment of Particles and Wall Loss
- Limited Sample Quantity
- Poor Particle Resolution for Size Analysis

## Errors in Sample Analysis

- Error associated with the analytical procedure should be considered in the overall error assessment of the sampling procedure

# Limitations and Sources of Error in Inertial Collection



## Size-Selective Inlets and Devices for Aerosol Sampling

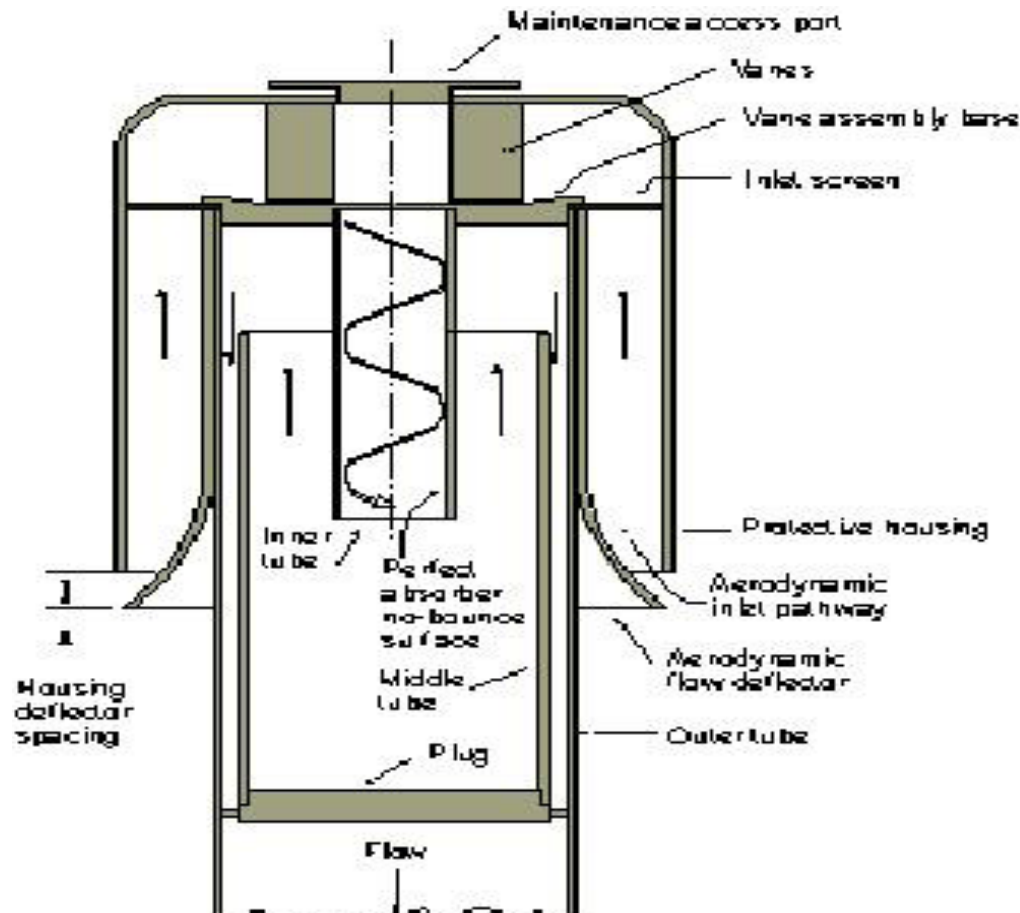

High-volume sampler with PM10 inlet

# Limitations and Sources of Error in Inertial Collection



Table 4-1. Size-selective inlets for aerosol sampling

Inlet Identifier (Manufacturer)	References	Operating Principle	d50 ( $\mu\text{m}$ ); Slope (no unit)	Flow Rate (L/min)	PM <sub>10</sub> Reference of Equivalence Reference No.	Comments
<i>High-Volume</i>						
SA <sup>a</sup> or GMC <sup>c</sup> Model 320 (Graseby Andersen, Atlanta, GA)	McFarland et al. (1980)	Impactor	15; 1.5	1,133	None	Single-stage, not greased shim.
SA or GMW Model 321A	McFarland and Ortiz (1984); Hayes et al. (1988)	Impactor	10.2; 1.45	1,133	RFPS-1287-065	Two-stage with greased shim.
SA or GMW Model 321B	Hayes et al. (1988); McFarland and Ortiz (1987)	Impactor	9.7; 1.40	1,133	RFPS-1287-064	Two-stage with greased shim.
SA or GMW Model 1200	Purdue (1988); Wedding et al. (1988); Mathai et al. (1988); Hoffman et al. (1988); Hayes et al. (1988)	Impactor	9.7; 1.40	1,133	RFPS-1287-063	Single-stage with greased shim (body hinged).

# Limitations and Sources of Error in Inertial Collection



Table 4-1. Size-selective inlets for aerosol sampling (cont')

GMW Wedding PM <sub>10</sub> (General Metal Works, Village of Cleves, OH)	Woods et al. (1986)	Cyclonic Flow	8.8; --	1,133	None	No inlet cleaning port.
Wedding IP <sub>10</sub> PM <sub>10</sub> (Wedding & Associates, Fort Collins, CO)	Wedding and Weignand (1985); Woods et al. (1986)	Cyclonic Flow	9.6; 1.37	1,133	RFPS-1087-062	Inlet cleaning port on top of inlet.
<i>Medium-Volume</i>						
SA 254 Medium-Volume PM <sub>10</sub> Inlet	Olin and Bohn (1983)	Impactor	10; 1.6 <sup>d</sup>	113	RFPS-0389-071	Several small screws must be removed to clean.
Wedding Medium Flow PM <sub>10</sub> Inlet	Wedding et al. (1983)	Cyclonic Flow	9.5; 1.12	113	None	Has a cleaning port. Can use a bottle brush to clean.
Bendix 240 Cyclone (Sensidyne, Inc., Clearwater, FL)	Chan and Lippman (1977); Mueller et al. (1983)	Cyclonic Flow	2.5; 1.7	113	None	Plastic cup acts as a hopper to collect large particles

# Limitations and Sources of Error in Inertial Collection



Table 4-1. Size-selective inlets for aerosol sampling (cont')

Sensidyne Model BDX 99R (Sensidyne Inc., Clearwater, FL)	Blackman and Lippman (1974); Hering (1995)	Cyclonic Flow	3.5; --	1.7	None	Also known as Dorr-Oliver design. Generally used in personal sampling applications.
SKC Cat. No. 225-01-02 (SKC Inc., Eighty Four, PA)	Blackman and Lippman (1974); Hering (1995)	Cyclonic Flow	5; --	1.9	None	Generally used in personal sampling applications.
MST Low Flow Rate Sharp Cut Impactor (Harvard Impactor) (Air Diagnostic and Engineering, Harrison, ME)	Marple et al. (1987)	Direct Impactor	2.5; 1.02 <sup>d</sup> 10; 1.11 <sup>d</sup>	4, 10, 20 4,10	None None	Oiled aluminum impactor plate needs to be replaced after every 24 hours of sampling. Designed for use in indoor air pollution health studies.

- a. See Table 4-5 for Federal Register citation and notice date.
- b. Sierra-Andersen, Atlanta, GA.
- c. General Metal Works, Atlanta, GA.
- d. Slope =  $\sqrt{d_{16}/d_{94}}$ , as defined in text.
- e. Slope is estimated based on  $\sqrt{d_{10}/d_{90}}$ .
- f. Inlet for Modules A, B, and C of IMPROVE samplers.

# Filtration Sampling

## Introduction

- A combination of filtration/impaction sampling
- Most widely used approach for the collection of atmospheric particulates
- Filters are relatively low in cost, easily stored, and used for subsequent simple and/or complex analyses of collected PM

## General Considerations

### *Advantages*

- Feasibility of handling large volume rates of flow
- The number of sizes of filters available
- Capable of sampling a wide range of environmental conditions of temperature, humidity, and dust loadings
- Adaptable to analysis schemes ranging from microscopic examination to elaborate chemical separation schemes

### *Disadvantages*

- Variations in physical and chemical properties of filters in any given filter type
- In conjunction with selective particle sizing



# Filtration Sampling

## The Theory of Filtration

### Contributing Mechanisms

*Diffusion*- the irregular movement of particles suspended in a fluid, where the fluid is ambient air

*Direct interception*- the part of the filter collection mechanism that is analogous to mechanical straining

*Inertial Collection*- If the inertia of a particle causes it to strike a filter fiber during the passage of the air stream around the fiber, the particle will be collected

*Electrical Force*- If the aerosol particle has an electrical charge, and the filter fiber has a charge of opposite sign, the particle will be attracted to the filter media

*Combined Factors*- all four of the above-mentioned collection mechanisms are working together so that it is often difficult to separate one from another



# Filtration Sampling

## Collection Efficiency of Filters

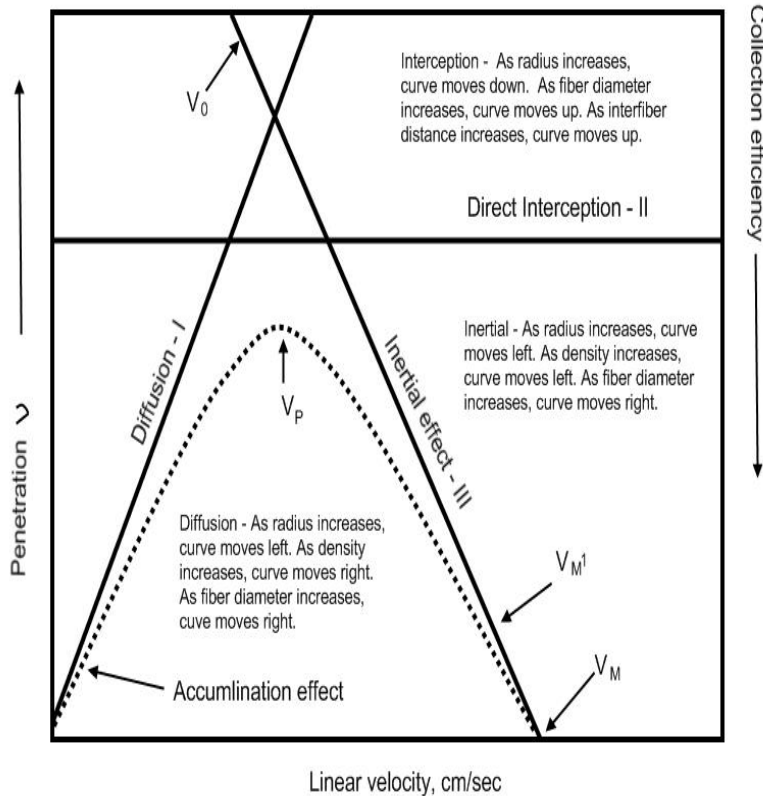

## Theory of Collection Efficiency

- Diffusion Efficiency
- Direct Interception Efficiency
- Inertial Effect Efficiency
- Overall Efficiency
- Experimental Collection Efficiencies

## Filtration mechanisms



# Filtration Sampling

## Collection Efficiency of Filters

Table 4-2. Collection efficiency of commonly used filter types for particles > 0.3  $\mu\text{m}$  diameter. Measurements made via Royco particle counter.<sup>a</sup>

Collection Efficiency (%) for Commonly Used Filter Types										
Filter	Size (mm)	No. of trials	Particle Size ( $\mu\text{m}$ ) in equivalent diameters							
			0.32	0.4	0.5	0.64	0.8	1.0	1.3	1.6
0.8 $\mu$ Nucleopore	47	1	82	96	99	99	100	100	100	100
5.0 $\mu$ Nucleopore	90	1	83	95	98	97	98	100	100	100
3.0 $\mu$ MF millipore (SS)	90	3	99.93	99.98	100	100	100	100	100	100
5.0 $\mu$ MF millipore (SM)	47	1	100	100	100	100	100	100	100	100
5.0 $\mu$ MF millipore (SM)	90	1	100	100	100	100	100	100	100	100
5.0 $\mu$ Teflon <sup>®</sup> millipore (LS)	90	1	99	99.6	100	100	100	100	100	100
8.0 $\mu$ MF millipore (SC)	47	1	96	99	99	99	96	99	100	—
10 $\mu$ Teflon <sup>®</sup> millipore (LC)	90	1	96	99	99	99	100	100	100	100
1.2 $\mu$ Silver membrane	47	2	99.9	100	100	100	100	100	100	100
S&S 0.45 (B6A) cellulose acetate	47	1	100	100	100	100	100	100	100	100
Gelman GA-1 cellulose acetate	47	1	99	100	100	100	100	100	100	100
<b>Glass fiber filters</b>										
Gelman A	47	2	99.8	99.8	99.6	99.7	99.1	99	99	97
Gelman A	25	1	100	100	100	100	100	100	100	100
Gelman A acid washed	25	1	99.9	100	100	100	100	100	100	100
Reeves angel # 900 AF	47	1	99.9	100	99.9	100	100	100	100	100
MSA 1106 BH	47	1	100	100	100	100	100	100	100	100
S&S #25 acid washed	47	3	26	53	65	64	69	71	79	88
TFA <sup>b</sup>	47	2	38	67	80	81	83	85	84	87
Whatman 41	47	1	63	83	90	84	89	81	94	100
S&S green ribbon #559	47	1	69	84	88	87	93	98	97	100

a. Face velocity in cm/sec for 25-, 47-, and 90-mm filters is 0.82, 0.31, and 0.11, respectively.

b. After sampling 500 ft<sup>3</sup> of room air, the filtration efficiency of TFA increased to 90% for 0.3  $\mu\text{m}$  particles with other values in the range of 80 to 90% for sizes up to 1.6  $\mu\text{m}$ . This efficiency was not significantly altered by discharging the filter over a radioactive source.

# Filtration Sampling

## Characteristics of Filter Media



### Cellulose Fiber Filters- Paper chemical filters

Table 4-3. Cellulose fiber filters.

Filter	Void size (microns)	Fiber diameter (microns)	Thickness (microns)	Weight per unit area (mg/cm <sup>2</sup> )	Ash content (%)	Maximum operating temp. (°C)	Tensile strength	Flow resistance 100 ft/min (in. H <sub>2</sub> O)
Whatman							1.67	
1	2+	—	130	8.7	0.06	150	kg/cm	40.5
4	4+	—	180	9.2	0.06	150		11.5
32	1-	—	150	10.0	0.025	150		38 (1 fm)
40	2	—	150	9.5	0.01	150		54
41	4+	—	180	9.1	0.01	150	1.41	8.1
							kg/cm	
42	>1	—	180	10.0	0.01	150		46 (28 1 fm)
44	>1	—	150	8.0	0.01	150		40 (28 1 fm)
50	1	—	100	10.0	0.025	150		49 (28 1 fm)
541	4+	—	130	8.2	0.008	150	2.24	—
							kg/cm	
S&S 604	—	—	200	—	0.03	80		8.5
MSA Type S	—	—	100.0	—	1.3	120		6.5
Cellulose	—	—	1000	—	1.3	120		
Corrugated	—	—	—	—	—	—		
Cellulose	—	—	1000	—	1.3	120		
MSA BM-2133	—	—	1830	32.7	0.12	—	0.58	9.1
							kg/cm	
IPC 1478	—	Av. 17	560-760	14.6	0.04	120	0.18	0.31
							kg/cm	
Gelman W-41	24	—	—	—	—	—		

- Sampling Considerations
- Specific Filters

# Filtration Sampling

## Characteristics of Filter Media

### Glass Fiber Filters

- Made from finely spun glass fiber by combining the fiber with an organic binder and compressing this material in a paper machine

Table 4-4. Glass fiber filter characteristics.

Filter	Void size (microns)	Fiber diameter (microns)	Thickness (microns)	Weight per unit area (mg/cm <sup>2</sup> )	Ash content (%)	Maximum operating temp. (°C)	Tensile strength	Flow resistance 100 ft/min (in. H <sub>2</sub> O)	Benzene extract/ 100 in. <sup>2</sup> (mg)
MSA									
1106B*			180-270	6.1	- 95	540	3.5 lb/in.	19.8	17.3
1106BH#			180-460	5.8	- 100	540	1.5 lb/in.	19.8	0.6
Gelman									
A#			380	9.3	99.4	480		18.9	
E*			380	10.0	98.1	480		18.9	
G			810	11.6		480		3.0	
M			580	10.8		480		6.1	
H			510	12.7		480		21.7	
Whatman									
AGF/A#	>1		340	5.3	100	540	1.29 lb/in.		0.8
AGF/B#	>1		840	15.0	100	540	3.14 lb/in.		3.2
AGF/D	>1		460	5.5	100	540	0.56 lb/in.	2.3@2 lfm	
AGF/E	>1		890	15.0	100	540	1.07 lb/in.		
AGF/F	>1		380	6.3	100	540	0.73 lb/in.		
H&V									
H≅93		0.6	460-560	9.3	96-99	540	2.5 lb/in.		
H≅94		0.5≅3	380	8.2	96-99	480	2.5 lb/in.		
S&S									
24*									
26#			200	6.05					0.3
27*			125-180		98	400			
29#			127	5.4	98	400			0.6

# without organic binder  
\* with organic binder

- Sampling Considerations
- Analysis Considerations
- Specific Filters

# Filtration Sampling

## Characteristics of Filter Media

### Mixed Fiber Filters

- Possess the characteristics of the individual fibers composing them



Table 4-5. Mixed fiber filter characteristics.

Filter designation	Composition	Void size (microns)	Fiber diameter (microns)	Thickness (microns)	Weight per unit area (mg/cm <sup>2</sup> )	Ash content (%)	Maximum operating temp. (°C)	Tensile strength	Flow resistance at 100 ft/min [ $\sim$ 50 cm/sec] (in. H <sub>2</sub> O)
H&V H $\cong$ 70, 9 mil	Cellulose asbestos		0.1-35	230	8.2	20-25	150	2.5 lb/in.	17
H $\cong$ 70, 18 mil	Cellulose asbestos		0.1-35	460	15.4	20-25	150	4.0 lb/in.	26
H $\cong$ 64	Cellulose asbestos		0.1-35	830-1090	22.7	15-20	150	2.0 lb/in.	15
H $\cong$ 90	Cellulose glass		9-35	685	13.4	70	150	3.2 lb/in.	0.4
H $\cong$ 91	Cellulose glass		1.5-35	710	13.5	80	150	3.5 lb/in.	0.89
N $\cong$ 15	Synthetic fiber & glass		0.5-15	1270	24.9	15	150	1.0 lb/in.	9.9
5 $\cong$ G	Synthetic fiberglass & cotton		0.5-15	685	14.5	4-6	150	gauze backed	2.0
MSA glass & cellulose	Glass & cellulose			1000			120		
Whatman ACG/A	Glass & cellulose	>1		330	5.5		150	270 gm/cm	0.9 (20 l fm)
ACG/B	Glass & cellulose	>1		990	19.5		150	330 gm/cm	2.6 (20 l fm)
H&V CWS $\cong$ 6	Cellulose asbestos			762		11%			17
H&V AEC $\cong$ 1	Cellulose asbestos			762		13%			13.3
VM $\cong$ 100 Gelman	Vinyl metracel	10.0							
VM $\cong$ 1	Vinyl metracel	5.0							



# Filtration Sampling

## Characteristics of Filter Media

### Membrane Filters

- Consists of dry gels of cellulose esters, usually produced as cellulose acetate or cellulose nitrate, polyvinyl chloride, acrylonitrile, and Teflon

Table 4-6. Membrane filter media.

Filter	Pore size (microns)	Index refraction	Thickness (microns)	Weight per unit area (mg/cm <sup>2</sup> )	Ash content (%)	Maximum operating temp. (°C)	Tensile strength	Flow resistance, 100 ft/min (in. H <sub>2</sub> O)
Millipore	SM	1.495	170	3.6	0.0001	125	100 psi	19
	SS	1.495	170	3.8	0.0001	125	150 psi	38
	WS		150	4.9	"	"		-100
	RA	1.512	150	4.2	"	"	300 psi	62
	AA	1.510	150	4.7	"	"	350 psi	91 (39)*
	DA	1.510	150	4.8	"	"	400 psi	120
	HA	1.510	150	4.9	"	"	450 psi	210
	WH	1.510	150	5.7	0.0001	"		-270
Gelman	AM≅1		200	3.6		"	0.41 kg/cm <sup>2</sup>	11
	AM≅3		200	6.6		"	0.72 kg/cm <sup>2</sup>	33
	AM≅4		200			"		73
	AM≅5		200			"		
	AM≅6		200	5.8		"		
	S&S	7.5		180-250	6.3-8.7	0.01	Continuous	
AF≅600						100		
AF≅400	4.0		180-250	6.3-8.7	0.01	Peak 200		
AF≅250	2.0		160-210	5.6-7.3	0.008	"		
AF≅150	0.85		160-210	5.6-7.3	0.008	"		
AF≅100	0.70		Av-150	Av 5.3	0.007	"		
AF≅50	0.60		Av-135	Av 4.7	0.006	"		
AF≅30	0.40		Av-120	Av 4.2	0.005	"		
Gelman	GM≅1	1.49				Dry 176		
	GM≅3	1.49				176		
	GM≅4	1.49				176		
	GM≅6	1.49				176		
	GM≅8	1.49				176		
	GM≅9	1.49				176		
	GM≅10	1.49				176		

\*Alternate value reported.



Sampling Considerations



Analysis Considerations

# Filtration Sampling

## Characteristics of Filter Media



Table 4-7. Commonly used filter media for particulate sampling and analysis.

Filter Type, (Major Manufacturer, and Catalog No. or Trade Name)	Filter Size	Physical Characteristics	Chemical Characteristics	Compatible Analysis Methods <sup>a</sup>	No. of Filters per Box
Ringed Teflon <sup>®</sup> - membrane (Gelman Scientific; Ann Arbor, MI; Teflon <sup>®</sup> R2PJ047, R2PJ037)	25 mm 37 mm 47 mm	Thin membrane stretched between polymethylpentane ring. White surface, nearly transparent. Minimal diffusion of transmitted light. High particle collection efficiencies. Cannot be accurately sectioned. 1.2, 2.0, 3.0, 5.0 and 10µm pore sizes (determined from liquid filtration). Melts at ~60°C. High flow resistance.	Usually low blank levels, but several contaminated batches have been found. Made of carbon-based material, so inappropriate for carbon analysis. Inert to adsorption of gases. Low hygroscopicity. Low blank weight.	Gravimetry, OA, XFR, PIXE, INAA, AAS, ICP/AES, ICP/MS, IC, AC	50 50 50
Ringed Teflon <sup>®</sup> - membrane (Pallflex, Putnam, CT)	25 mm 37 mm 47 mm	Thin film of Teflon <sup>®</sup> attached to polyolefin ring without adhesive.	Made of carbon-based material, so inappropriate for carbon analysis. Inert to adsorption of gases. Low hygroscopicity. Low blank weight.	Gravimetry, OA, XRF, PIXE, INAA, AAS, ICP/AES, ICP/MS, IC, AC	25 25
Backed Teflon <sup>®</sup> membrane, (Gelman Scientific, Ann Arbor, MI; "Zeflour"; 2µm, P5PJ037 or P5PJ047; 1µm, P5PL037 or P5PL047)	37 mm 47 mm 20.3 × 25.4cm	Thin membrane mounted on thick polypropylene backing. White opaque surface, diffuses transmitted light. High particle collection efficiencies. Melts at ~60°C. High flow resistance. 1 µm and 2 µm pore sizes.	Usually low blank levels. Made of carbon-based material, so inappropriate for carbon analysis. Inert to adsorption of gases. Higher background levels for XRF and PIXE than Teflon <sup>®</sup> owing to greater filter thickness. Low hygroscopicity. High blank weight.	Gravimetry, XRF, PIXE, INAA, AAS, ICP/AES, ICP/MS, IC, AC	50 50 25

# Filtration Sampling

## Characteristics of Filter Media



Table 4-7 Cont'

Backed Teflon <sup>®</sup> membrane, (Pallflex, Putnam, CT)	25 mm 37 mm 47 mm	TFE porous membrane on TFE support. Smooth surface. 0.30 $\mu\text{m}$ @ 99% efficiency.	Neutral pH. Usually low blank levels. Made of carbon-based material, so inappropriate for carbon analysis. Inert to adsorption of gases. Higher background levels for XRF and PIXE than Teflon <sup>®</sup> , due to greater filter thickness. Low hygroscopicity. High blank weight. Retains average tare weight of 7.6 grams.	Gravimetry, XRF, PIXE, INAA, AAS, ICP/AES, ICP/MS, IC, AC	50 50
Nylon membrane, (Gelman Scientific, Ann Arbor, MI: "Nylasorb", #66509)	47 mm 90 mm	Thin membrane of pure nylon. White opaque surface, diffuses transmitted light. 1 $\mu\text{m}$ pore size. Melts at $\sim 60^{\circ}\text{C}$ . High flow resistance.	High $\text{HNO}_3$ collection efficiency. Passively adsorbs low levels of $\text{NO}$ , $\text{NO}_2$ , PAN, and $\text{SO}_2$ . Low hygroscopicity. Low blank weight.	IC, AC	100 50
Silver membrane (Millipore Corp., Marlborough, MA)	25 mm <sup>b</sup> 37 mm <sup>c</sup>	Thin membrane of sintering, uniform metallic silver particles. Grayish-white surface diffuses transmitted light. Melts at $\sim 350^{\circ}\text{C}$ . High flow resistance.	Resistant to chemical attack by all fluids. Passively adsorbs organic vapors. Low hygroscopicity. High blank weight.	Gravimetry, XRD	50 25
Cellulose esters membrane (Millipore Corp., Marlborough, MA; "Nitrocellulose")	37 mm 47 mm <sup>d</sup>	Thin membrane of cellulose nitrate mixed esters, and cellulose acetate. White opaque surface diffused transmitted light. 0.025, 0.05, 0.1, 0.22, 0.30, 0.45, 0.65, 0.80, 1.2, 3.0, 5.0, and 8.0 $\mu\text{m}$ pore sizes. Melts at $\sim 70^{\circ}\text{C}$ . High flow resistance.	High hygroscopicity. Negligible ash content. Dissolves in many organic solvents. Low blank weight.	Gravimetry, OM, TEM, SEM, XRD Biomedical applications	100 100

# Filtration Sampling

## Characteristics of Filter Media



Table 4-7 Cont'

Polyvinyl Chloride membrane (Millipore Corp., Marlborough, MA)	25 mm 37 mm 47 mm	Hospital-grade polyvinyl chloride membrane. White opaque surface, diffuses transmitted light. 0.2, 0.6, 0.8, 2.0, and 5.0 $\mu\text{m}$ pore sizes. Melts at $\sim 50^\circ\text{C}$ . High flow resistance.	Dissolves in some organic solvents. High hygroscopicity. Low blank weight.	XRD	100 100 100
Polycarbonate membrane, (Corning CoStar, [formerly Nuclepore Corp.], Cambridge, MA; #111129) (Poretics, Minnetonka, MN)	25mm 37mm 47mm <sup>b</sup>	Smooth, thin, polycarbonate surface with straight through capillary holes. Used for particle size classification. Light gray surface, nearly transparent. Minimal diffusion of transmitted light. Low particle collection efficiencies, <70% for some larger pore sizes. Retains static charge. 0.1, 0.3, 0.4, 0.6, 1.0, 2.0, 3.0, 5.0, 8.0, 10.0, and 12.0 $\mu\text{m}$ uniform pore sizes. Melts at $\sim 60^\circ\text{C}$ . Moderate flow resistance.	Low blank levels (made of carbon-based material, so inappropriate for carbon analysis). Low hygroscopicity. Low blank weight.	Gravimetry, OA, OM, SEM, XRF, PIXE	100 100 100
Pure quartz-fiber (Pallflex Corp., Putnam, CT; 2500 QAT-UP)	25 mm 37 mm 47 mm 20.3 $\times$ 25.4 cm	Mat of pure quartz fibers. White opaque surface, diffuses transmitted light. High particle collection efficiencies. Soft and friable edges flake in most filter holders. Melts at $>900^\circ\text{C}$ . Moderate flow resistance.	Pre-washed during manufacture - low blank levels for ion. Contains large and variable quantities of Al and Si. Some batches contain other metals. Passively adsorbs organic vapors. Adsorbs little $\text{HNO}_3$ , $\text{NO}_2$ , and $\text{SO}_2$ . Low hygroscopicity.	ICP/AES, ICP/MS, IC, AC, T, TOR, TMO, TOT, OA	100 25 25 25



# Filtration Sampling

## Characteristics of Filter Media

Table 4-7 Cont'



Mixed quartz-fiber (Whatman Corp., Hillsboro, OR; QM/A #1861865)	37 mm 47 mm 20.3 × 25.4 cm	Quartz (SiO <sub>2</sub> ) fibers with ~5% borosilicate content. White opaque surface, diffuses transmitted light. High particle collection efficiencies. Some batches can melt at ~500°C. Effects on thermal carbon analysis are unknown. Becomes brittle when heated. Low flow resistance.	High blank weight. Contains large and variable quantities of Na, Al, and Si in all batches. Variable levels of other metals are found in many batches. Passively adsorbs organic vapors. Adsorbs little HNO <sub>3</sub> , NO <sub>2</sub> , and SO <sub>2</sub> . Low hygroscopicity. High blank weight.	Gravimetry, XRF, PIXE, AA, ICP/AES, ICP/MS for some metals, IC, AC, T, TOR, TMO, TOT	100 100 25
Cellulose-fiber 41 (Whatman Corp., Hillsboro, OR; #1441047)	25 mm 47 mm	Thick mat of cellulose fibers, often called a "paper" filter. White opaque surface, diffuses transmitted light. Low particle collection efficiencies, <70% for some variations of this filter. High mechanical strength. Burns at elevated temperatures (~150°C, exact temperature depends on nature of particle deposit). Variable flow resistance.	High purity, low blank levels. Made of carbon-based material, so inappropriate for carbon analysis. Adsorbs gases, especially water vapor. Most appropriate for adsorbing gases such as HNO <sub>3</sub> , SO <sub>2</sub> , NH <sub>3</sub> , and NO <sub>2</sub> when impregnated with reactive chemicals. High hygroscopicity. High blank weight.	Gravimetry, XRF, PIXE, INAA, AAS, ICP/AES, ICP/MS, IC, AC	100 100
Cellulose-fiber 31ET (Whatman Corp., Hillsboro, OR; #3031F915)	47 mm 46×47 cm		High purity, low blank levels. Made of carbon-based material, so inappropriate for carbon analysis. Adsorbs gases, especially water vapor. Most appropriate for adsorbing gases such as HNO <sub>3</sub> , SO <sub>2</sub> , NH <sub>3</sub> , and NO <sub>2</sub> when impregnated with reactive chemicals. High hygroscopicity. High blank weight.	Gravimetry, XRF, PIXE, INAA, AAS, ICP/AES, ICP/MS, IC, AC	100 25

# Filtration Sampling

## Characteristics of Filter Media



Table 4-7 Cont'

Teflon <sup>®</sup> -coated glass-fiber (Pallflex, Putnam, CT; TX40H120)	37 mm 47 mm	Thick mat of borosilicate glass fiber with a layer of Teflon <sup>®</sup> on the surface. Glass fiber supporting Teflon <sup>®</sup> is shiny. High particle collection efficiencies. Glass melts at ~500°C. Teflon <sup>®</sup> melts at ~60°C. Low flow resistance.	Low blank levels for ions (glass backing and carbon content make it less suitable for elemental and carbon analyses). Inert to adsorption of HNO <sub>3</sub> , NO <sub>2</sub> , and SO <sub>2</sub> . Low hygroscopicity. High blank weight.	Gravimetry, IC, AC	100 100
Glass fiber (Gelman Scientific, Ann Arbor, MI; Type A/E)	25 mm 47 mm 20.3 × 25.4 cm  (available in 13 mm to 293 mm sizes)	Borosilicate glass fiber. White opaque surface, diffuses transmitted light. High particle collection efficiencies. Melts at ~500°C. Low flow resistance.	High blank levels. Adsorbs HNO <sub>3</sub> , NO <sub>2</sub> , SO <sub>2</sub> , and organic vapors. Low hygroscopicity. High blank weight.	Gravimetry, OA, XRF, PIXE, INAA, AAS, ICP/AES, IC, AC	500 100 100

- a
- AAS = Atomic Absorption Spectrophotometry
  - AC = Automated Colorimetry
  - IC = Ion Chromatography
  - ICP/AES = Inductively-Coupled Plasma with Atomic Emission Spectrophotometry
  - ICP/MS = Inductively-Coupled Plasma with Mass Spectrophotometry
  - INAA = Instrumental Neutron Activation Analysis
  - OA = Optical Absorption or Light Transmission (b<sub>abs</sub>)
  - OM = Optical Microscopy
  - PIXE = Proton-Induced X-Ray Emissions
  - SEM = Scanning Electron Microscopy
  - T = Thermal Carbon Analysis
  - TEM = Transmission Electron Microscopy
  - TMO = Thermal Manganese Oxidation Carbon Analysis
  - TOR = Thermal/Optical Reflectance Carbon Analysis
  - TOT = Thurman Optical Transmission Carbon Analysis
  - XRD = X-Ray Diffraction
  - XRF = X-Ray Fluorescence

b Available in 0.45 μm pore size.

c Available in 0.80 μm pore size.

d Filter disc is available in-size between 13 mm to 293 mm, depending on the pore size.

e Available by special order.

# Sample Problems

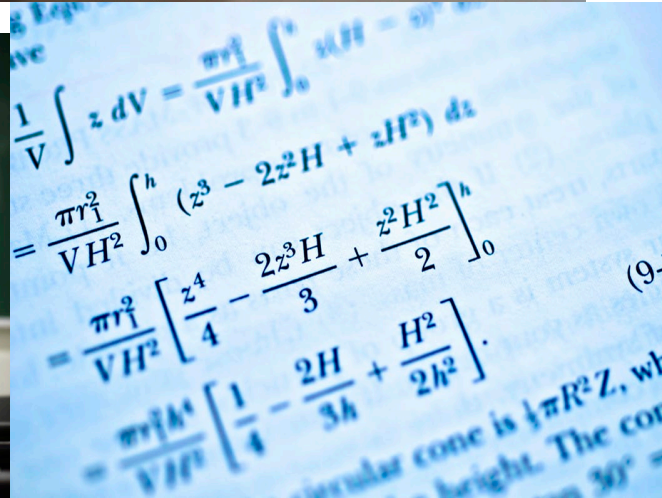
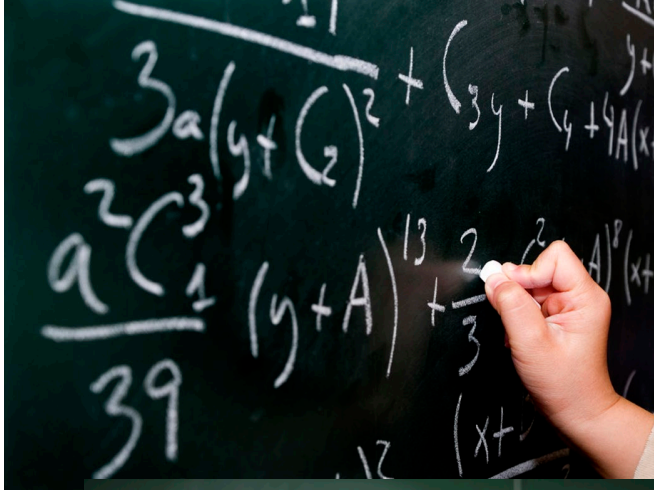

# Gravitational Sampling

-The amount of precipitation (solid or liquid) which reaches the ground over a stated period of time.



NACAA  
National Association of Clean Air Agencies

## Dustfall Bucket or Jar

- One of the earliest sampling devices
- Used mostly as a bulk collector for wet and dry deposition
- Results calculated by filtering liquid, with subsequent weighing of remaining solids

## Precipitation Collectors

- Non-recording type gauges
  - Constructed of a cylinder closed at one end and a measuring ruler
- Recording type gauges (2 types)
  - Weighing-type gauges
  - Tipping bucket-type gauges

# Electrostatic Precipitators

## Principles of Electrostatic Precipitation

Two Advantages:

- The sampling rate is not affected by mass loading
- The collected sample is in a readily recoverable form

Two Operations involved in collection:

- Electrically charging the particles
- Accelerating the charged particles toward an oppositely charged electrode

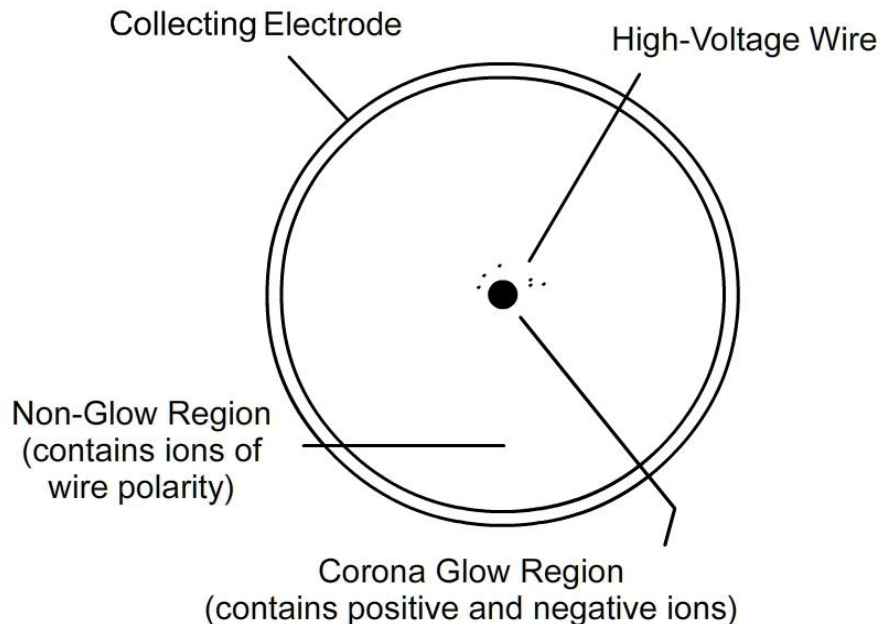

Collection Efficiency  
Specific Applications

Axial view of high voltage corona discharge

# Thermal Precipitators

- Collect particles from an air stream by passing the air sample through a narrow channel having a significant temperature gradient perpendicular to the direction of flow

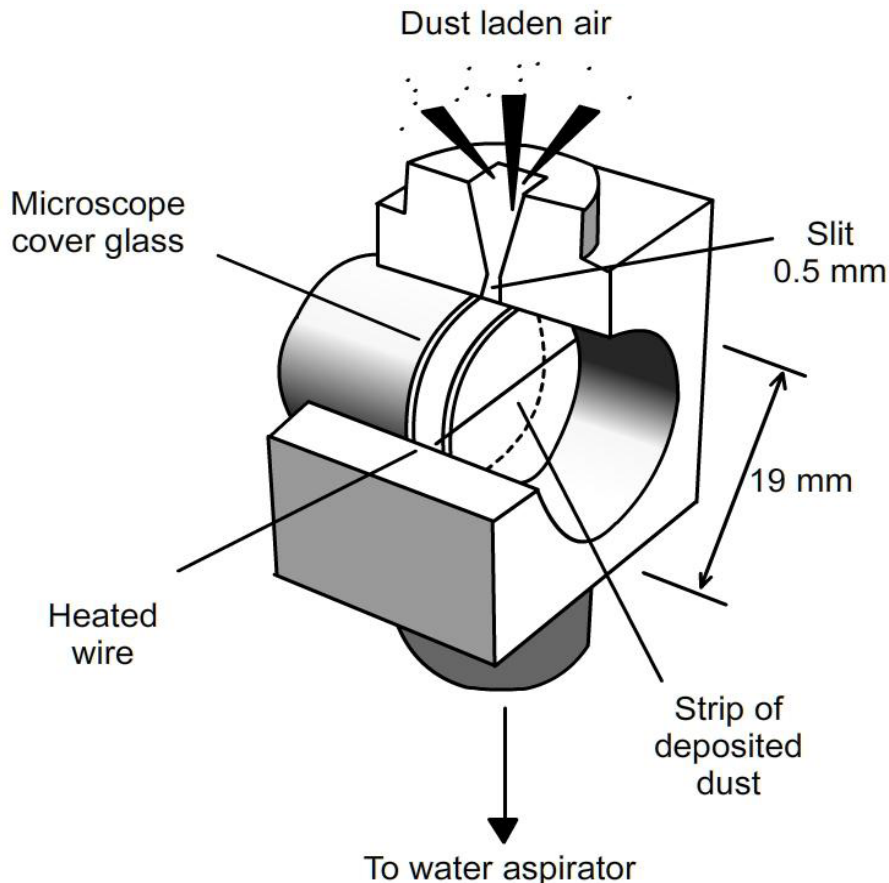

- Collection Efficiency and Deposition pattern
- Advantages
- Disadvantages

Sampling head of thermal precipitator

# APTI 435: Atmospheric Sampling Course Chapter 4



Questions?



Summary

# Chapter 5

## Methodologies and Instrumentation for Particulate Matter Sampling



---

APTI 435: Atmospheric Sampling Course





# Terminal Learning Objective



- At the end of the chapter, the student will be able to describe the methods and instruments used in particulate matter sampling.



# Enabling Learning Objectives

- 5.1 Understand overview of chapter.
- 5.2 Describe high-volume sampling for suspended particulate matter (SPM) and air toxics.
- 5.3 Describe high-volume air sampling.
- 5.4 Describe the FRM for the determination of particulate matter as  $PM_{10}$ .
- 5.5 Identify the FRM and FEM for the determination of fine particulate matter as  $PM_{2.5}$ .

# Enabling Learning Objectives (cont)



- 5.6 Identify the FRM and FEM for the determination of coarse particles (PM<sub>10</sub>-PM<sub>2.5</sub>).
- 5.7 Summarize the operating principles of adsorption when sampling gaseous pollutants.
- 5.8 Explain the procedures for *in situ* monitoring for particulate matter.
- 5.9 Describe automated Federal Equivalent Monitors.
- 5.10 Describe additional automated PM methods.

## 5.2 High-Volume Sampling for Suspended Particulate Matter (SPM) and Air Toxics



- Air pollution control agencies determine air pollution in their communities and the effectiveness of their control programs
- They collect samples of suspended, inhalable, and respirable Particulate Matter (PM)
- Suspended Particulate Matter (SPM) in air generally is a complex, multi-phase system of all airborne solid and low-vapor pressure liquid particles having aerodynamic particle sizes from below 0.01  $\mu\text{m}$  to 100  $\mu\text{m}$  and larger
- Inhalable PM is the fraction of Suspended Particulate Matter (SPM) that is capable of being respired into the human respiratory system in significant quantities
  - ✓ Referred to as Coarse Particles or Thoracic Coarse particles

## 5.2 High-Volume Sampling for Suspended Particulate Matter (SPM) and Air Toxics



- Another subset of SPM includes a size fraction of particles with an aerodynamic diameter of the less than  $2.5 \mu\text{m}$ , which is referred to as respirable PM
- The smaller particles ( $\text{PM}_{2.5}$ ) are able to reach the lower regions of the human respiratory tract
- Responsible for most of the adverse health effects associated with suspended particulate pollution
- This size fraction is more commonly referred to as *fine* particles

## 5.2 High-Volume Sampling for Suspended Particulate Matter (SPM) and Air Toxics



- Atmospheric particles can be identified based on the two distinct modes in which they occur
- The fine ( $<2.5 \mu\text{m}$ ) mode and the coarse ( $2.5\text{-}10.0 \mu\text{m}$ ) mode
  - ✓ The fine or accumulation mode (or respirable particulate matter) is attributed to the growth of particles from the gas phase and subsequent agglomeration
- Coarse mode is made of mechanically abraded or ground particles

## 5.2 High-Volume Sampling for Suspended Particulate Matter (SPM) and Air Toxics



- Several different sampling techniques and devices - filtration, electrostatic and thermal precipitation, and inertial separators
- Employed to collect suspended particulate pollutants from ambient air
- Filtration and inertial separation have been found to be the most suitable for routine air sampling
- The EPA has designated the high-volume method as the reference method for TSP matter and  $PM_{10}$  when outfitted with a size selective inlet

## 5.2 High-Volume Sampling for Suspended Particulate Matter (SPM) and Air Toxics



Method	Pollutant or Pollutant Category	Sample Collection Media
TSP <sup>1</sup>	TSP	quartz filter
PM <sub>10</sub> <sup>2</sup>	PM <sub>10</sub>	quartz filter
Lead (Pb) <sup>3</sup>	Lead (Pb)	quartz filter
TO-4A <sup>4</sup>	Pesticides & PCBs	PUF cartridge
TO-9A <sup>4</sup>	Dioxins & furans	quartz filter & PUF cartridge
TO-13A <sup>4</sup>	PAHs	quartz filter & PUF cartridges or XAD-2™
IO-3.1 <sup>5</sup>	metals	quartz filter, other
IO-3.2 <sup>5</sup>	metals	quartz filter
IO-3.4 <sup>5</sup>	metals	quartz filter
IO-3.5 <sup>5</sup>	metals	quartz filter
IO-3.6 <sup>5</sup>	metals	quartz filter
IO-3.7 <sup>5</sup>	metals	quartz filter

**Table 5-1. Summary of sampling and analytical methods utilizing the high-volume method to sample PM, metals, and semi-volatile compounds.**



# 5.3 High-Volume Air Sampling



## Introduction

- Samplers previously used
- TSP levels decreased – TSP samplers diminished
- TSP FRM remains as the official sampling method for obtaining samples to determine compliance with the national ambient air quality standard for lead

# 5.3 High-Volume Air Sampling



## Development of the High-Volume Sampler

- **1948 – Silverman Aerosol Collector**
  - ✓ Operated at a much higher flow rate than other available samplers - identified as a high-volume sampler
- **1950s - Staplex**
  - ✓ Cast aluminum motor housing
  - ✓ Adoption of a stainless steel filter holder to accommodate an 8- by 10-inch filter permitted 24-hour operation of the sampler
- **1957 – General Metal Works**
  - ✓ More rugged sampler needed

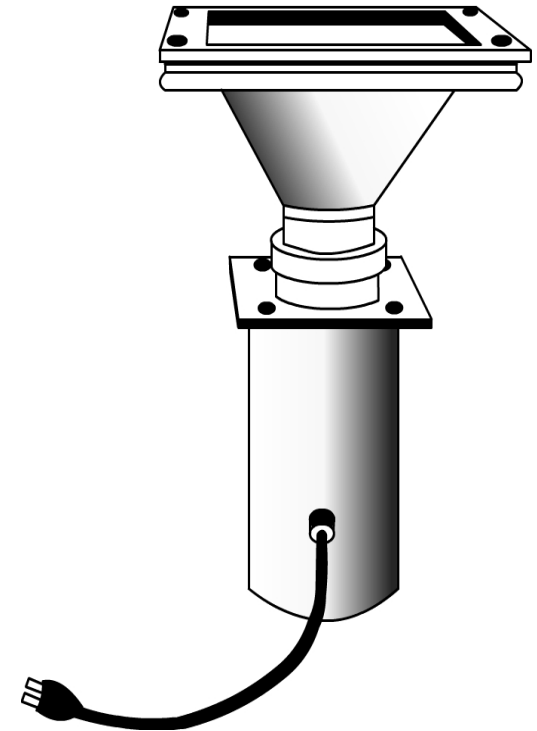

Figure 5-1. Hi-vol sampler components (motor, filter, housing).

# 5.3 High-Volume Air Sampling



## Sampler-Shelter Combination

- The sampler and its shelter should be considered as a single, functioning unit
- The shelter must provide protection for the sampler, and at the same time allow unrestricted access of ambient air from all directions without direct impingement of particles on the filter

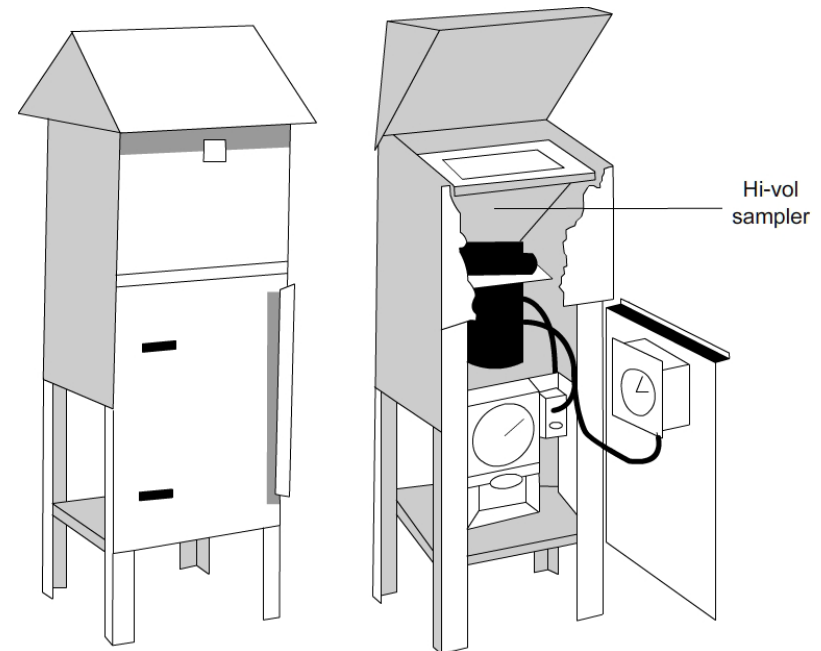

Figure 5-2. Hi-vol sampler in shelter.

# 5.3 High-Volume Air Sampling



## Sampler-Shelter Combination

- The standard peak roof of the shelter, which acts as a plenum above the filter, is placed to provide a total opening area of slightly more than the 63-square-inch exposed filter area
- The size of the opening to the filter and the volume of air filtered per unit time will affect the particle size range collected

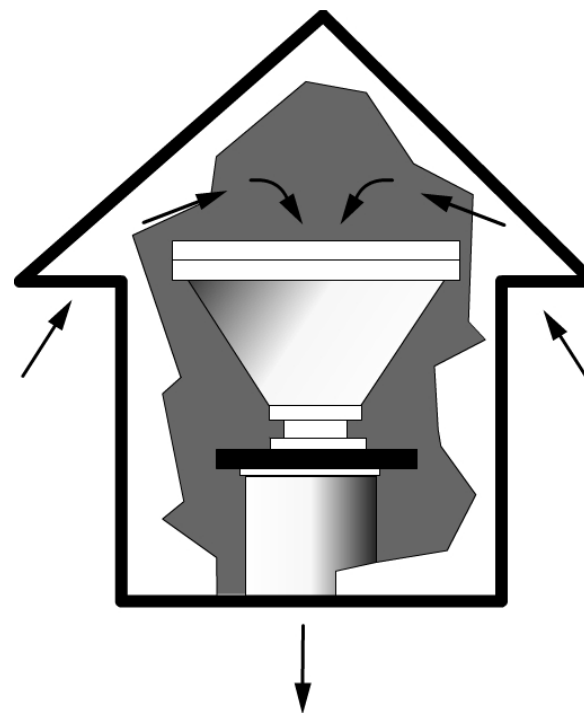

Figure 5-3. Air flow of hi-vol sampler in shelter.

# 5.3 High-Volume Air Sampling

## Filter Media for High-Volume Sampler



Size	20.3 ± 0.2 × 25.4 ± 0.2cm (nominal 8 × 10 in.)
Nominal exposed area	406.5 cm <sup>2</sup> (63 in. <sup>2</sup> )
Material	Glass fiber filter or other relatively inert, non-hygroscopic material
Collection efficiency	99% minimum is measured by the DOP test (ASTM-2986) for particles of 0.3-μm aerodynamic diameter
Recommended pressure drop range	42 to 54 mm Hg (5.6 to 7.2 kPa) at a flow rate of 1.5 std m <sup>3</sup> /min through the nominal exposed area
pH	6 to 10
Integrity	2.4 mg maximum weight loss
Tear strength	500 g minimum for 20-mm wide strip cut from filter in weakest dimension (ASTM Test D828-60)
Brittleness	No cracks or material separations after single lengthwise crease
Lead content	Low Pb concentration desirable (typical Pb content 75 μg/filter). Low degree of Pb content variability between filters of the same batch.

**Table 5-2. U.S. EPA specifications for TSP filters. Additional specification for TSP filters used for the determination of lead in SPM.**

# 5.3 High-Volume Air Sampling



## Precautions in Filter Handling

- Desired filters should be permanently identified by stamping a serial number on two diagonally opposite corners
- Care should be taken not to tear the filter
- Inspect filters for holes, tears, particles, or other imperfections that may cause uneven loading, loss of particulate matter
- Equilibrate for at least 24 hours in a conditioning environment before the filters are weighed

# 5.3 High-Volume Air Sampling



## Precautions in Filter Handling

- Installing a New Filter
- Removing Old Filters

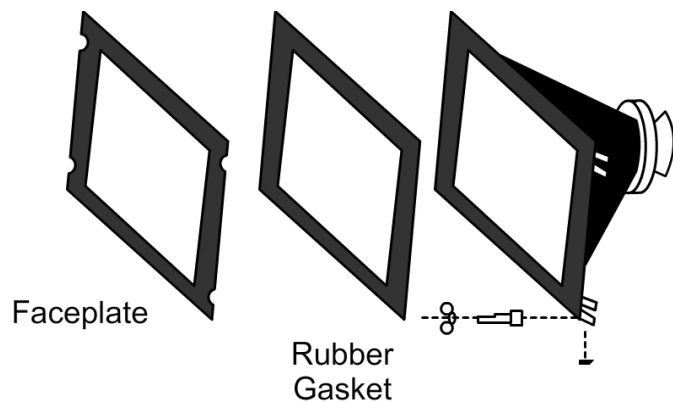

Figure 5-4. Hi-vol sampler filter adapter assembly.

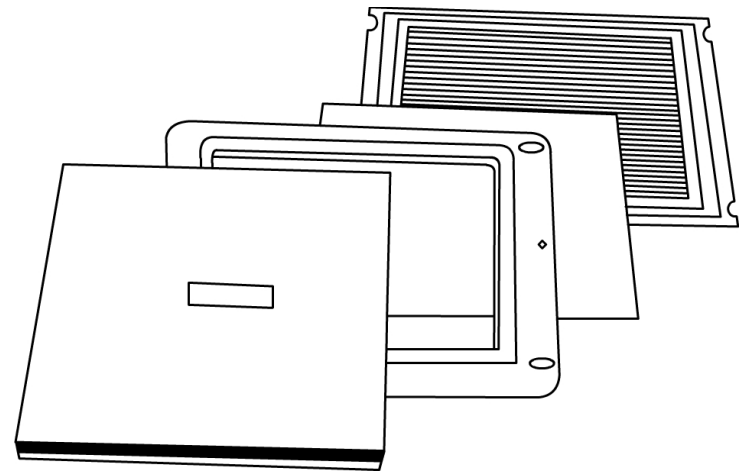

Figure 5-5. Hi-vol filter cartridge.

# 5.3 High-Volume Air Sampling



## Precautions in Filter Handling

Documentation of all these steps is for legal purposes and to ensure data reliability. The operator who starts the sampler is responsible for recording the following information:

1. Filter serial number
2. Sampling site identification number and/or address
3. Sampler identification number
4. Starting time
5. Initial sampling flow rate
6. Sampling date (including day, month, and year)
7. Summary of conditions that may affect results (e.g., meteorology, construction activities, etc.)
8. Operator's initials or signature
9. Ambient temperature and barometric pressure



# 5.3 High-Volume Air Sampling



## Precautions in Filter Handling

The operator who removes the sample is responsible for recording the following information:

1. Stop time and elapsed time (if available)
2. Final sampling flow rate
3. Operator's initials or signature
4. Ambient temperature and barometric pressure, if necessary (see calibration section of this chapter)
5. Comments concerning voided samples
6. Summary of existing conditions that may affect results

# 5.3 High-Volume Air Sampling

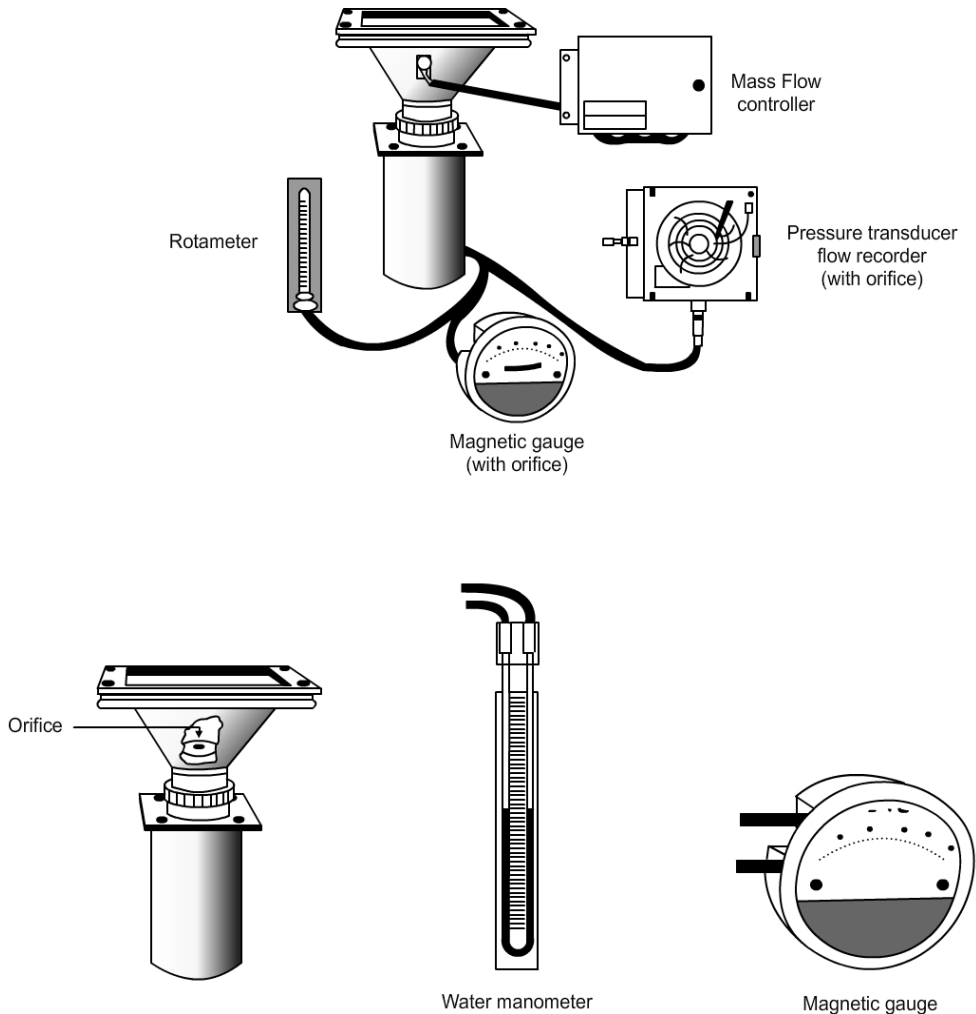

## Calibration

- Most high-volume samplers use an orifice/pressure indicator, an electronic mass flowmeter, or a rotameter (visifloat) for measuring sampling flow rate
- EPA has specified procedures in Appendix B of 40 CFR 50

Figure 5-6. Typical flow rate indicating devices.

# 5.3 High-Volume Air Sampling



## Calibration

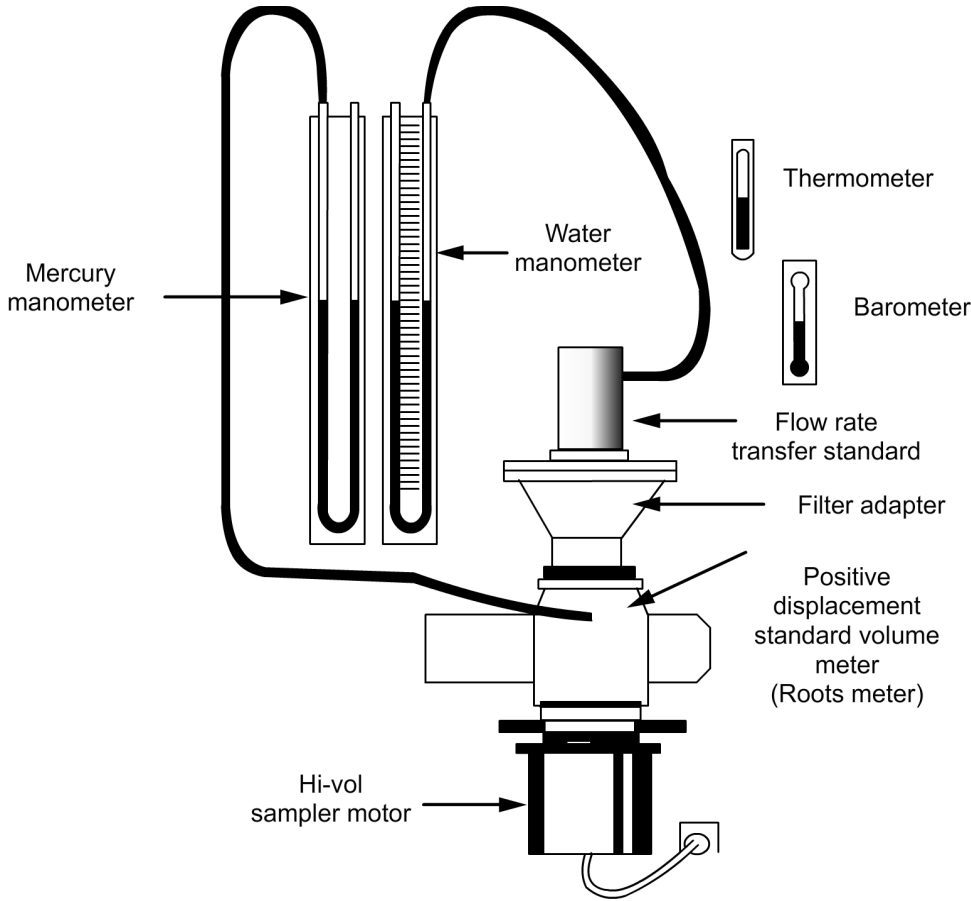

Figure 5-7. Flow rate transfer standard calibration setup.

# 5.3 High-Volume Air Sampling



## Calibration

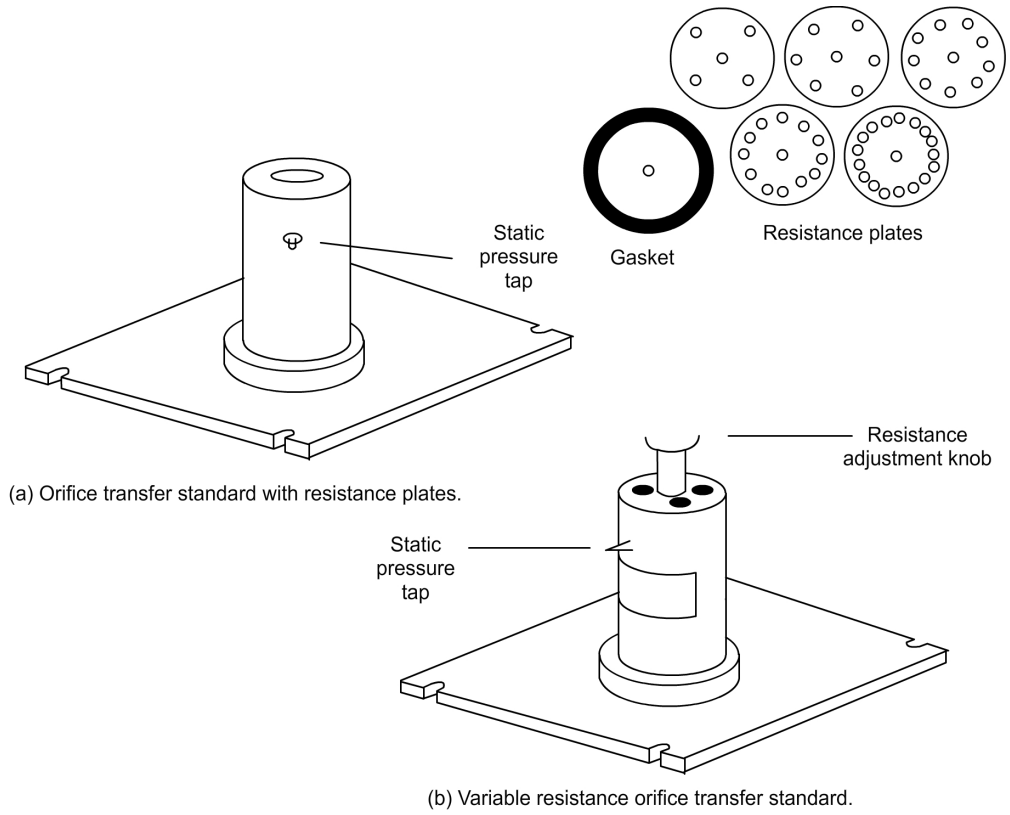

Figure 5-8. Typical orifice-type flow rate transfer standards.

# 5.3 High-Volume Air Sampling



## Calibration

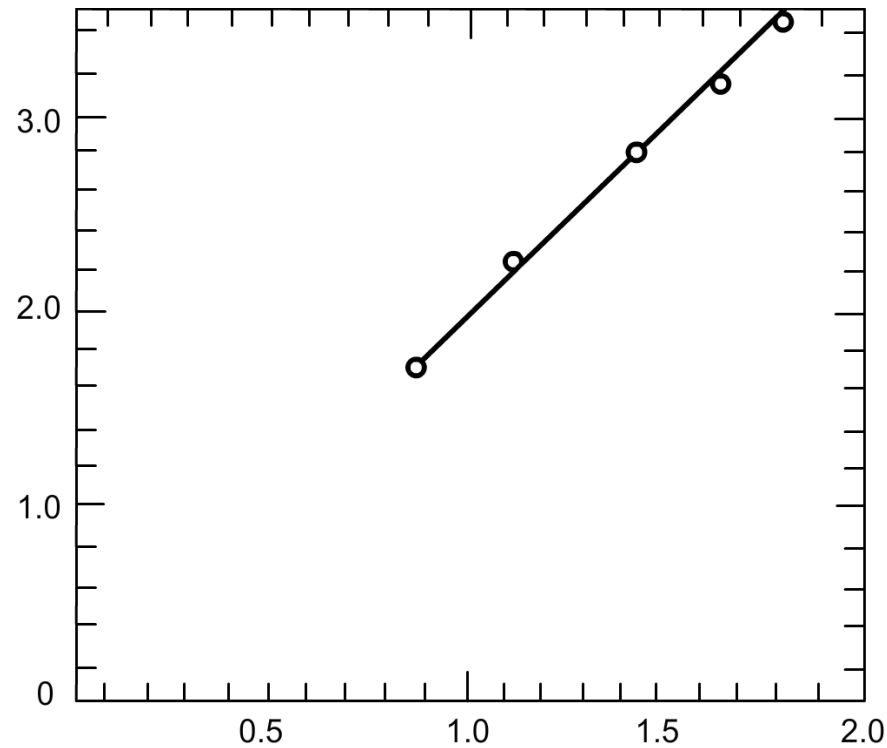

Figure 5-9. Typical calibration curve for a flow rate transfer standard.

# 5.3 High-Volume Air Sampling



## Calibration

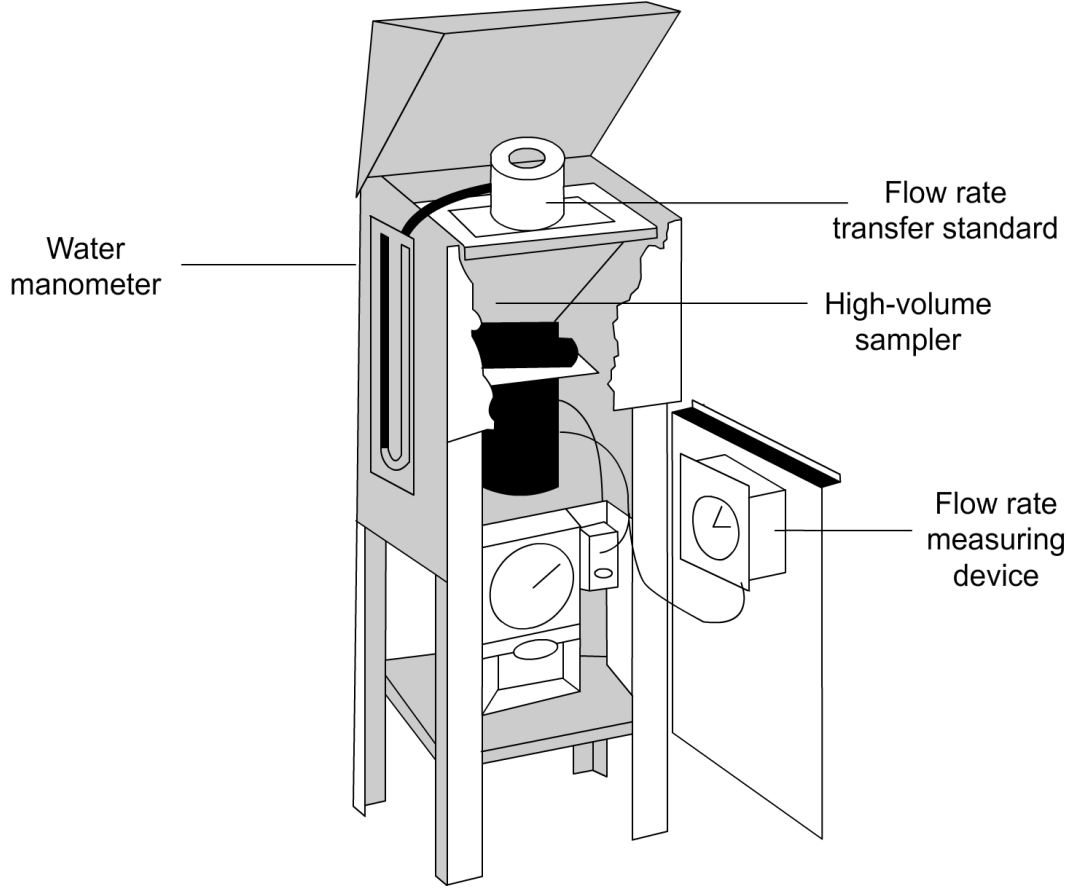

Figure 5-10. Flow rate measuring device calibration setup.



# 5.3 High-Volume Air Sampling

## Calibration

Table 5-3. Formulas for expressing indicated flow rates of sampler flow rate measuring device calibration.

Type of sampler flow rate measuring device	Expression	
	For actual pressure (P <sub>2</sub> ) and temperature (T <sub>2</sub> ) corrections	For incorporation of geographic average barometric pressure (P <sub>a</sub> ) and seasonal average temperature (T <sub>a</sub> )
Mass flowmeter	I	I
Orifice and pressure indicator	$\sqrt{I \left( \frac{P_2}{P_{std}} \right) \left( \frac{298}{T_2} \right)}$	$\sqrt{I \left( \frac{P_2}{P_a} \right) \left( \frac{T_a}{T_2} \right)}$
Rotameter, or orifice and pressure recorder having a square root scale*	$\sqrt{I \left( \frac{P_2}{P_{std}} \right) \left( \frac{298}{T_2} \right)}$	$\sqrt{I \left( \frac{P_2}{P_a} \right) \left( \frac{T_a}{T_2} \right)}$

\* This scale is recognizable by its non-uniform divisions and is the most commonly available for high-volume samplers.

# 5.3 High-Volume Air Sampling



## Calibration

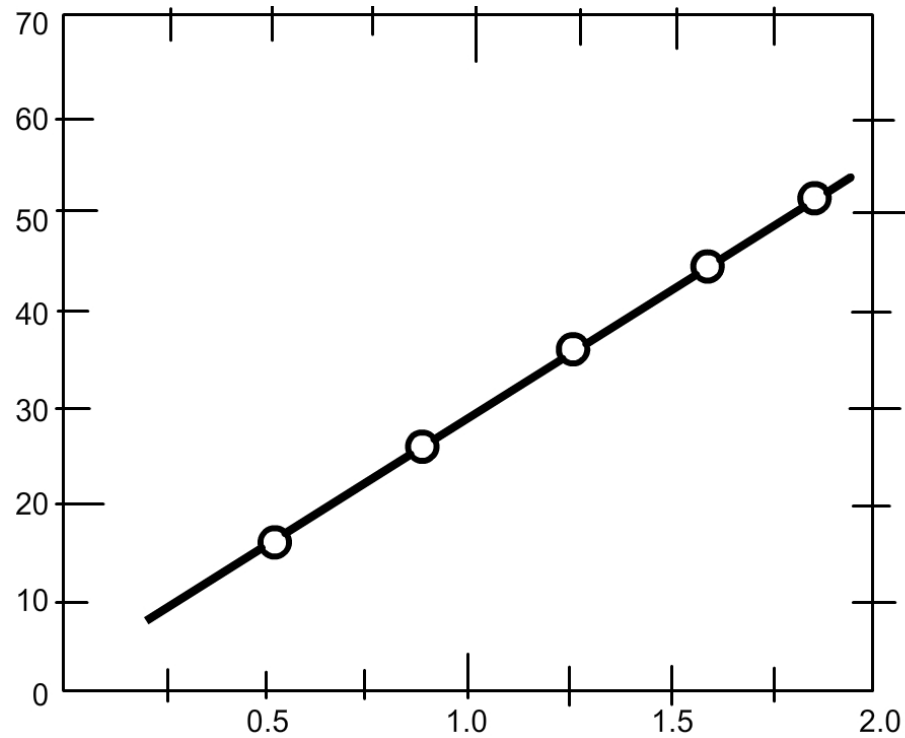

Figure 5-11. Typical calibration curve for a sampler flow rate measuring device.



# 5.3 High-Volume Air Sampling

## Calibration

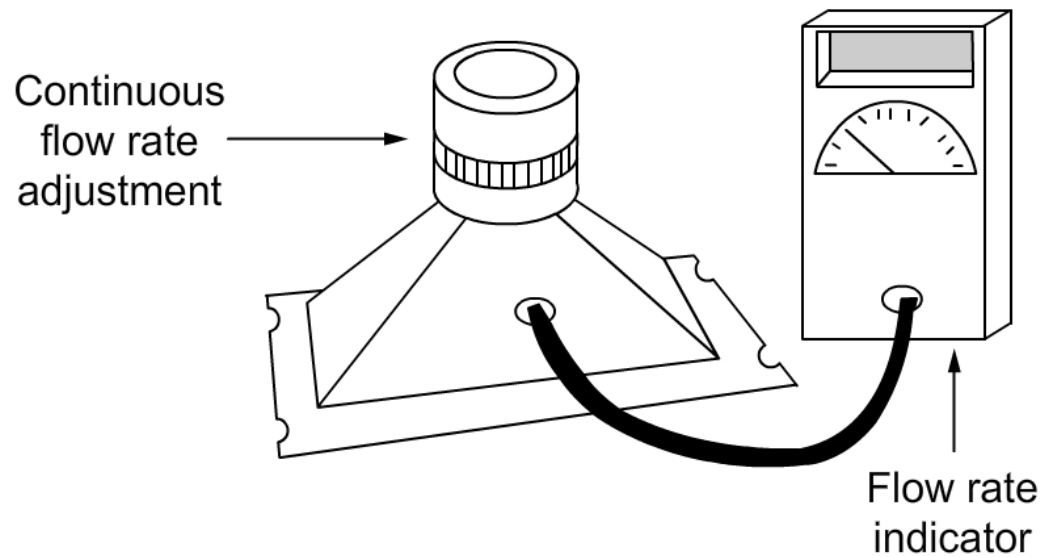

Figure 5-12. Electronic flowmeter transfer standard with externally adjustable resistance.

# 5.3 High-Volume Air Sampling



## U.S. EPA High-Volume Sampling Procedure for TSP (Appendix B of 40 CFR 50)

- This procedure is specified in Appendix B of 40 CFR 50 for the sampling of suspended particulate matter
- Refer to pages 5-18 thru 5-24 of Chapter 5's Student Manual

# 5.3 High-Volume Air Sampling



## Analysis of High-Volume Filters

- After a filter has been weighed, it can be cut into sections for subsequent analysis.
- Destructive extraction techniques preparing the filter for analysis are organic solvent extraction, acid extraction, and aqueous extraction.
- To determine the amount of organic aerosol present in the ambient air, organics on a portion of a filter can be extracted with an organic solvent, such as chloroform, in conjunction with a Soxhlet<sup>®</sup> extractor

# 5.3 High-Volume Air Sampling



## Sampling Accuracy and Precision

Factors influencing the accuracy and precision of high-volume sampling include:

1. Sampler operating characteristics
2. Accuracy of calibration
3. Filter characteristics
4. Location of sampler
5. Nature and concentration of particulate matter and gases in the air being sampled
6. Humidity of the air

# 5.3 High-Volume Air Sampling



## Accuracy

- The degree of agreement between an observed value and an accepted reference value
- It includes a combination of random error (precision) and systematic error (bias) components which are due to sampling and analytical operations

# 5.3 High-Volume Air Sampling



## Accuracy

- The accuracy of the particulate measurements can be affected by several known inherent sources of error in the sampling of particulate matter to include:
  1. Airflow variation
  2. Air volume measurement
  3. Loss of volatiles
  4. Artifacts
  5. Humidity
  6. Filter handling
  7. Non-sampled particulate matter
  8. Timing errors
  9. Recirculation of sampler exhaust
  10. Wind speed and direction sensitivity

# 5.3 High-Volume Air Sampling



## Precision

- Defined as the measurement of mutual agreement among individual measurements of the same property, usually under prescribed similar conditions, expressed generally in terms of standard deviation
- Collocated samplers should be used to estimate precision under field conditions for high-volume samplers of air monitoring networks

# 5.3 High-Volume Air Sampling



## Maintenance

- The high-volume sampler requires less maintenance than most air monitoring instruments
- Preventive maintenance is needed to ensure dependable operation
- sampler motor maintenance consists of periodic motor brush replacement usually after 400 to 500 hours of operation at normal line voltage of 115 volts
- Worn brushes, if not replaced, will result in damage to the motor



# 5.3 High-Volume Air Sampling



## Maintenance

<b>Equipment</b>	<b>Acceptance Limits</b>	<b>Frequency and method of measurement</b>	<b>Action if requirements are not met</b>
Sampler motor	400 h of motor brush operation; no malfunction	Visually check upon receipt and after every 400 h of operation	Replace motor brushes; other maintenance as indicated
Faceplate gasket	No leaks at the filter seal	Visually check after each sampling period	Replace the gasket
Flow rate measuring device	No foreign materials; stable operation	Visually check for each sample	Clean; replace if damaged
Motor gaskets	Leak-free fit	Visually check after each 400 h of operation	Replace gaskets
Filter adapter (sampling head)	No leaks	Visually check after each 200 h of operation	Replace filter adapter

**Table 5-5. High-volume sampler maintenance activities.**

## 5.4 FRM for the Determination of Particulate Matter as PM<sub>10</sub>



### Applicability

- The Federal Reference Method (FRM) for PM<sub>10</sub> described here is provided from Appendices J and M of 40 CFR Part 50
- This method provides for the measurement of the mass concentration of particulate matter with an aerodynamic diameter less than or equal to a nominal 10 μm (PM<sub>10</sub>) in ambient air over a 24-hour period for purposes of determining attainment and maintenance of the primary and secondary national ambient air quality standards for particulate matter.

# 5.4 FRM for the Determination of Particulate Matter as PM<sub>10</sub>



## Principle

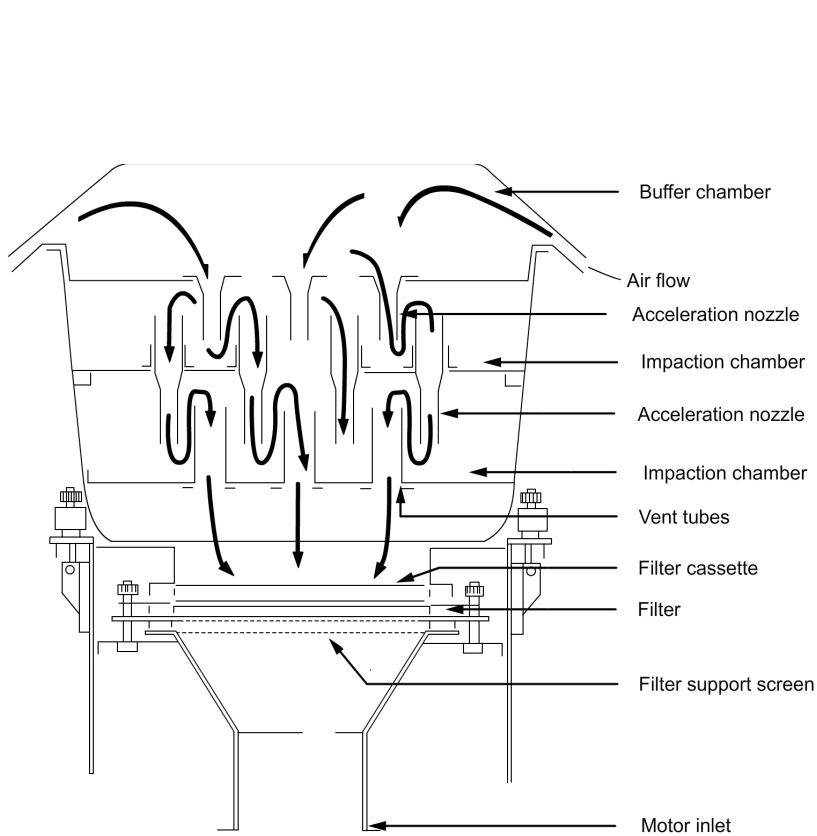

Figure 5-19. Schematic diagram of an impaction inlet.

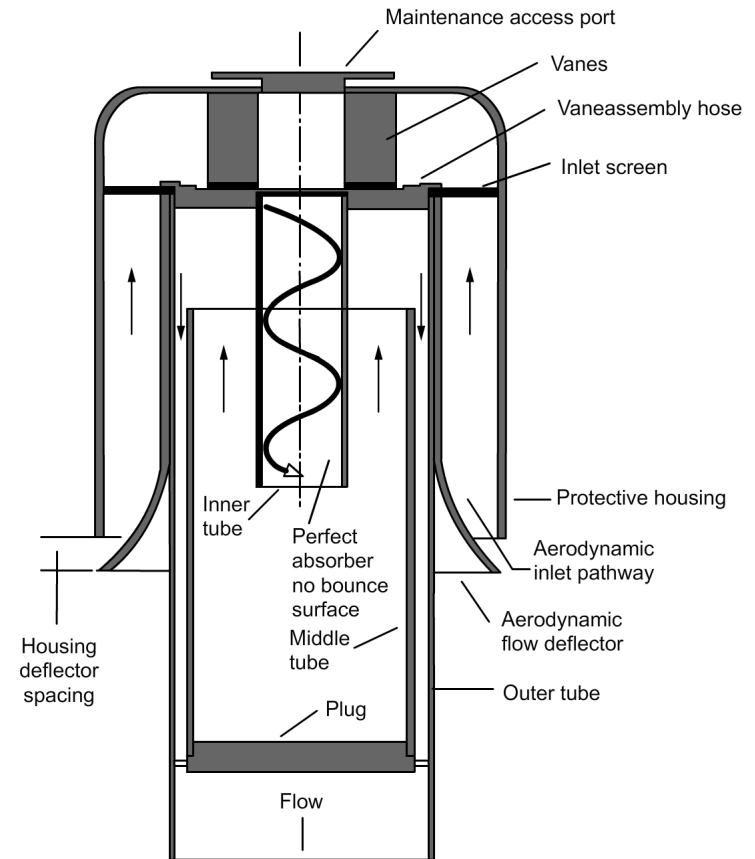

Figure 5-20. Schematic diagram of a cyclonic inlet.

## 5.4 FRM for the Determination of Particulate Matter as PM<sub>10</sub>



### Range

- The lower limit of the mass concentration range is determined by the repeatability of filter tare weights
- For samplers having an automatic filter-changing mechanism, there may be no upper limit
- For samplers that do not have an automatic filter-changing mechanism, the upper limit is determined by the filter mass loading

## 5.4 FRM for the Determination of Particulate Matter as PM<sub>10</sub>



### Accuracy

- SLAMS Measurement System Accuracy
- Initial Operational Accuracy of a FRM Sampler



## 5.4 FRM for the Determination of Particulate Matter as PM<sub>10</sub>

### Potential Sources of Error

- Volatile Particles
- Artifacts
- Humidity
- Filter Handling
- Flow Rate Variation
- Air Volume Determination



## 5.4 FRM for the Determination of Particulate Matter as PM<sub>10</sub>

### PM<sub>10</sub> Sampler Apparatus

The sampler is designed to:

- Draw the air sample into the sampler inlet and through the particle collection filter at a uniform face velocity
- Hold and seal the filter in a horizontal position so that sample air is drawn downward through the filter
- Allow the filter to be installed and removed conveniently,
- Protect the filter and sampler from precipitation and prevent insects and other debris from being sampled
- Minimize air leaks that would cause error in the measurement of the air volume passing through the filter
- Discharge exhaust air at a sufficient distance from the sampler inlet to minimize the sampling of exhaust air
- Minimize the collection of dust from the supporting surface



## 5.4 FRM for the Determination of Particulate Matter as PM<sub>10</sub>

### Filter Media

- User's goal of determining concentration, other factors such as cost, ease of handling, and physical and chemical characteristics all contribute to the specific filter chosen for sampling
- Filter specifications are provided in the FRM and address collection efficiency, integrity, and alkalinity
- The filter medium collection efficiency must be greater than 99% as measured by the Dioctyl Phthalate (DOP) test, American Society of Testing Materials (ASTM) 2986



# 5.5 FRM and FEM for the Determination of Fine Particulate Matter as PM<sub>2.5</sub>



## Introduction

- Several samplers have been approved by EPA as FRM and FEM samplers for PM<sub>2.5</sub>
- Some FEM samplers can provide a higher level of convenience and mass concentration information than traditional FRM samplers
- Specific Class designations of FEM samplers are based on the degree of deviation from FRM samplers

## 5.5 FRM and FEM for the Determination of Fine Particulate Matter as PM<sub>2.5</sub>



### Reference Methods for PM<sub>2.5</sub> (FRM)

- FRM sampler measures the mass concentration of fine particulate matter, having an aerodynamic diameter less than or equal to 2.5  $\mu\text{m}$  (PM<sub>2.5</sub>), in ambient air over a 24-hour period
- Provides data to determine whether the primary and secondary National Ambient Air Quality Standards for fine particulate matter are met
- Measurement process is considered to be nondestructive
- PM<sub>2.5</sub> sample obtained can be subjected to subsequent physical or chemical analyses

# 5.5 FRM and FEM for the Determination of Fine Particulate Matter as PM<sub>2.5</sub>



## Measurement Range

- Lower Concentration Range
- Upper Concentration Range
- Sample Period

# 5.5 FRM and FEM for the Determination of Fine Particulate Matter as PM<sub>2.5</sub>



## Precision

- SLAMS Measurement System Precision
- Precision Measurements Using Collocated Procedures for Automated and Manual Methods of PM<sub>2.5</sub>
- Initial Operational Precision of a FRM Sampler

## 5.5 FRM and FEM for the Determination of Fine Particulate Matter as PM<sub>2.5</sub>



### Accuracy and Bias

- SLAMS Measurement System Accuracy and Bias
- Automated Flow Check Accuracy
- Manual Flow Check Accuracy
- Initial Operational Accuracy of a FRM Sampler
- Measurement System Bias

## 5.5 FRM and FEM for the Determination of Fine Particulate Matter as PM<sub>2.5</sub>



### Filter for PM<sub>2.5</sub> Sample Collection

- The filters specified in the FRM for PM<sub>2.5</sub> are 46.2 mm diameter filters of polytetrafluoroethylene (PTFE Teflon®), with an integral support ring made of polymethylpentene (PMP) or equivalent inert material
- The method includes other filter specifications such as pore size, filter thickness, maximum pressure drop, and filter weight stability

# 5.5 FRM and FEM for the Determination of Fine Particulate Matter as PM<sub>2.5</sub>



## PM<sub>2.5</sub> Sampler Configuration

- The sampler consists of a sample air inlet, down-tube, particle size separator (impactor), filter holder assembly, air pump, flow rate control system, and a flow rate measurement device

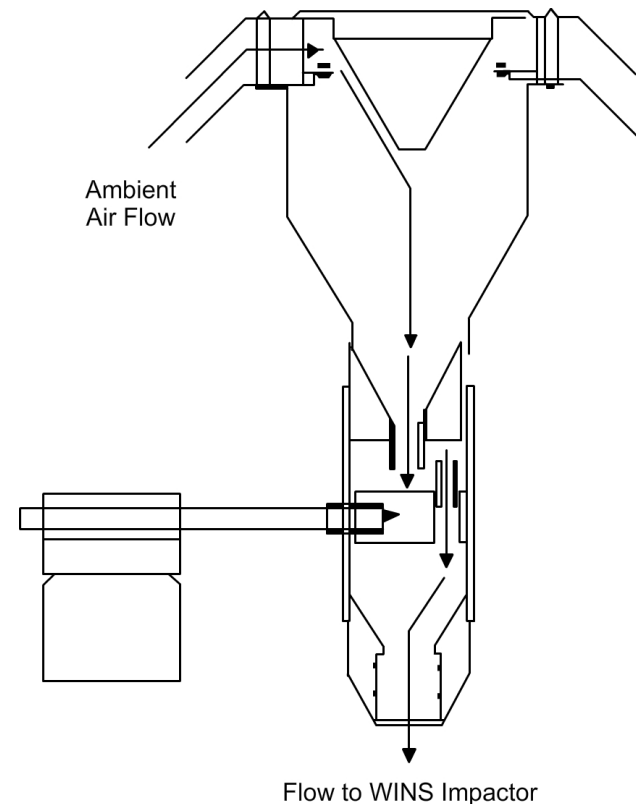

Figure 5-23. Schematic of PM<sub>2.5</sub> ambient air sampler inlet.

## 5.5 FRM and FEM for the Determination of Fine Particulate Matter as PM<sub>2.5</sub>



### Designated Methods for PM<sub>2.5</sub>

- The “List of Designated Reference and Equivalent Methods” is updated as necessary to reflect any new designations or any cancellation of a designation in effect
- This list can be obtained at EPA’s Ambient Monitoring Technology Information (AMTIC) webpage



## 5.5 FRM and FEM for the Determination of Fine Particulate Matter as PM<sub>2.5</sub>



### Equivalent Methods for PM<sub>2.5</sub> (FEM)

- Much wider latitude in their design, configuration, and operating principle than FRMs
- Not required to be based on filter collection of PM<sub>2.5</sub>
- Must demonstrate both comparability to FRM measurements and similar PM<sub>2.5</sub> measurement precision
- Three classes of equivalent methods have been established in the 40 CFR Part 53 regulations

## 5.5 FRM and FEM for the Determination of Fine Particulate Matter as PM<sub>2.5</sub>



### Limitations of PM<sub>2.5</sub> Reference and Class I Equivalent Methods

- One limitation is maintaining the specified ambient air flow rate through the sampling inlet and filter assembly
- Another important limitation involves changes in the weight of a collected sample due to mishandling, chemical reactions, and volatilization
- Errors in the gravimetric analysis of samples can also result from the buildup of electrostatic charge on filters

## 5.5 FRM and FEM for the Determination of Fine Particulate Matter as PM<sub>2.5</sub>



### Approved Regional Methods (ARMS)

- Automated, continuous PM<sub>2.5</sub> instruments approved for use within a state, local, or tribal agency used to meet multiple monitoring objectives such as National Ambient Air Quality Standards (NAAQS) and Air Quality Index (AQI)
- ARMs are similar to Class III (continuous) FEMs

## 5.5 FRM and FEM for the Determination of Fine Particulate Matter as $PM_{2.5}$



### Calculations

The  $PM_{2.5}$  concentration is calculated as:  $PM_{2.5} = (W_f - W_i) / V_{act}$

Where:

- $PM_{2.5}$  = mass concentration of  $PM_{2.5}$ ,  $\mu g/m^3$
- $W_f, W_i$  = final and initial weights, respectively of the filter used to collect the  $PM_{2.5}$  particle sample in  $\mu g$
- $V_{act}$  = total air volume sample at actual ambient air conditions as provided by the sampler,  $m^3$

## 5.6 FRM and FEM for the Determination of Coarse Particles ( $PM_{10}$ - $PM_{2.5}$ )



- Coarse particles consist of  $PM_{10}$  subtracted by  $PM_{2.5}$  ( $PM_{10}-PM_{2.5}$ )
- Mostly SLAMS sites in the National Core (NCore) network, require the measurement of coarse particles
- Coarse particles are sampled by FRM and/or FEM methods
- FRM determination of  $PM_{10}-PM_{2.5}$
- FEM Class I determination
- FEM Class II (i.e. dichotomous) and Class III (automated, continuous methods) requirements are currently being developed by EPA

# 5.7 PM<sub>2.5</sub> Specialization Sampling



## Introduction

- Purpose of Speciation Sampling is to better understand the chemical composition of PM<sub>2.5</sub>
- Target analytes in STN/SLAMS are similar to those within the Interagency Monitoring of Protected Visual Environments (IMPROVE)
- 40 CFR Part 53 requirements

# 5.7 PM<sub>2.5</sub> Specialization Sampling



## Speciation Samplers Developed

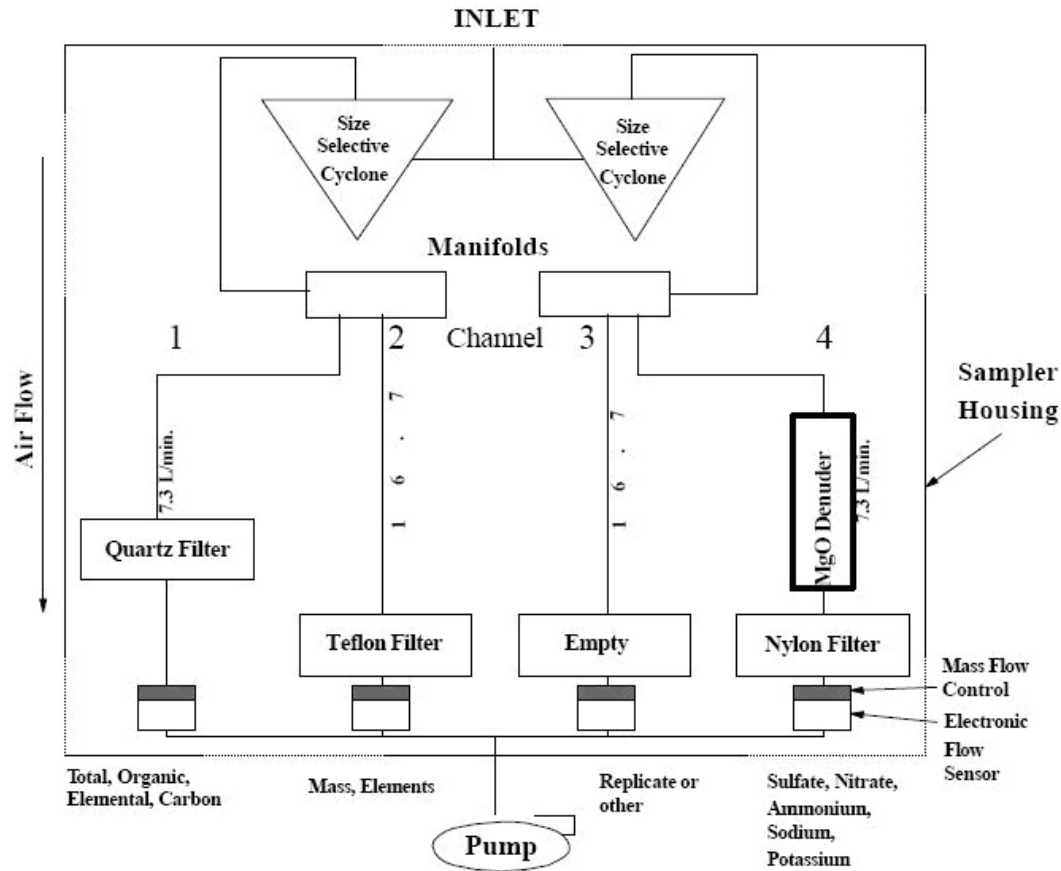

Figure 5-24. Schematic diagram of the Andersen Reference Ambient Air Sampler (RAAS™).

# 5.7 PM<sub>2.5</sub> Specialization Sampling



## Speciation Samplers Developed

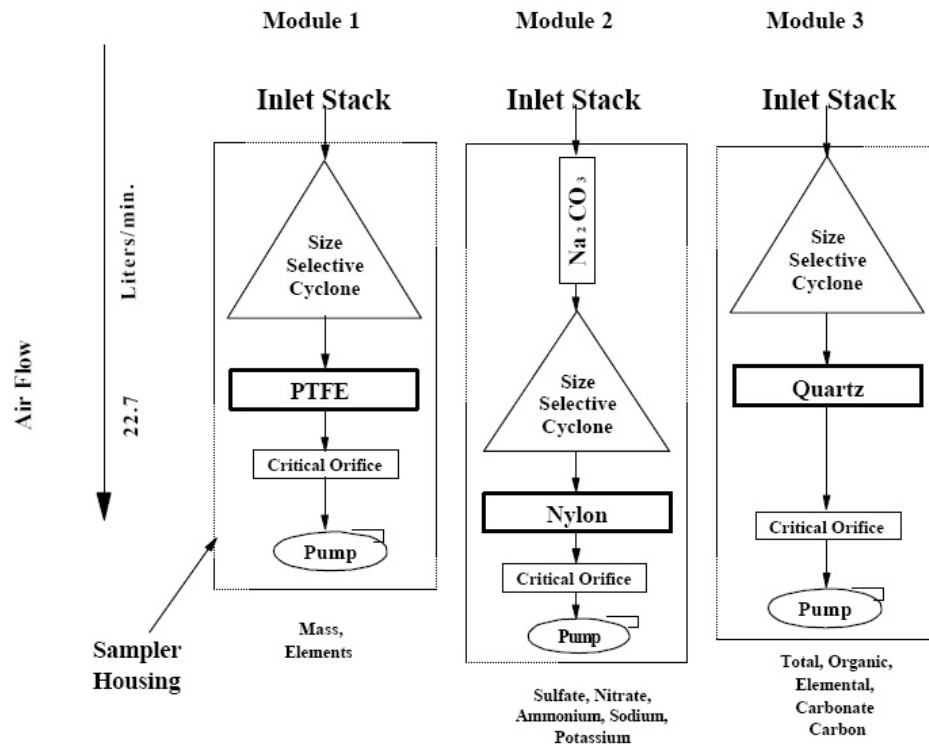

Figure 5-25. Schematic diagram of the IMPROVE sampler modules.



# 5.7 PM<sub>2.5</sub> Specialization Sampling



## Speciation Samplers Developed

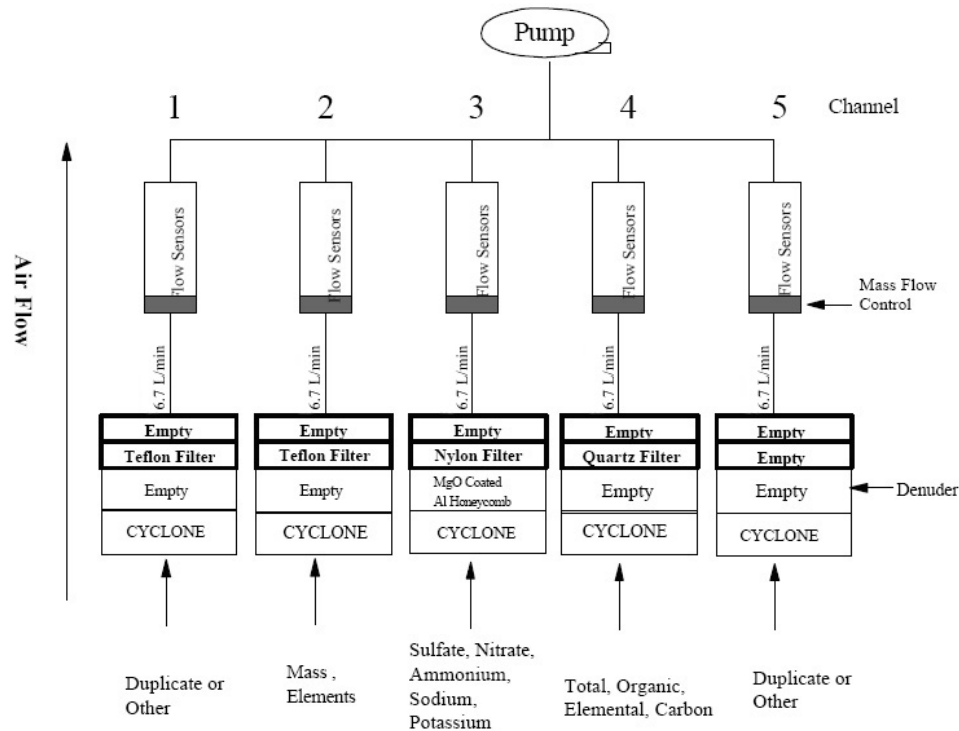

Figure 5-26. Schematic diagram of the MET ONE SASS™ sampling system.

# 5.7 PM<sub>2.5</sub> Specialization Sampling



## Speciation Samplers Developed

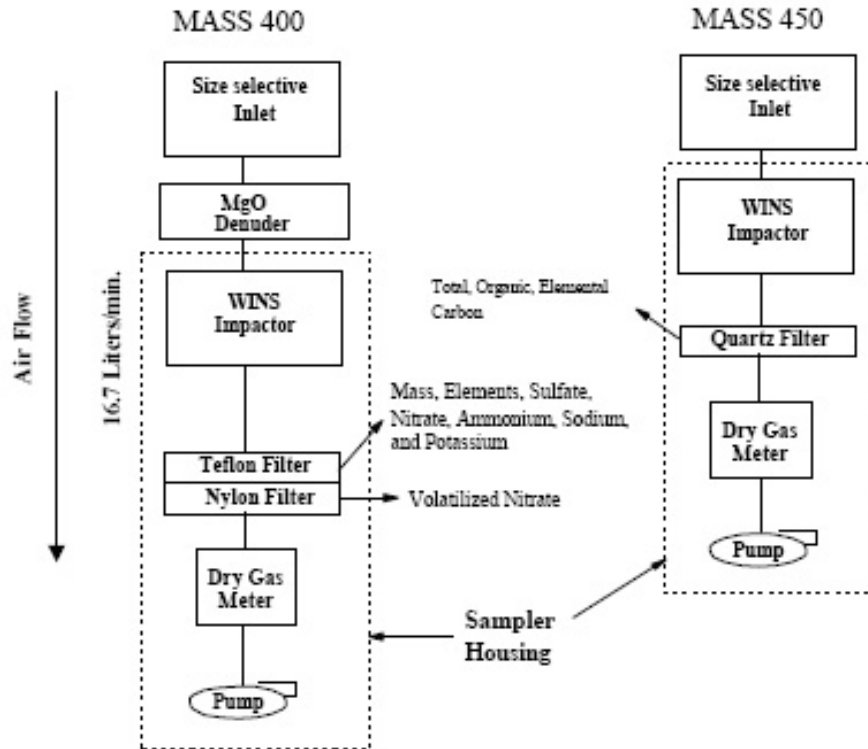

Figure 5-27. Schematic diagram of the URG Mass Aerosol Speciation Sampler (MASS).

# 5.7 PM<sub>2.5</sub> Specialization Sampling



## Specialization Samplers Developed

The performance-based criteria are based on the following design considerations:

- Particle Size Inlets
- Denuder
- Filter Types
- Flow Rate Measurement
- Filter Temperature Measurement
- Barometric Pressure Measurement
- Relative Humidity Measurement

# 5.8 Continuous *in situ* Monitoring for Particulate Matter



## Introduction

- Continuous *in situ* Particulate Matter (PM) Monitors measure at least one characteristic or property of aerosols (particles suspended in air) for quantification and/or characterization purposes
- They can obtain PM mass concentration, particle size distribution, and chemical speciation information
- Can be approved by EPA as a Class III Federal Equivalent Method (FEM) or Approved Regional Methods (ARMs)
- The main advantage of continuous instruments is their ability to provide time-resolved measurements

# 5.8 Continuous in situ Monitoring for Particulate Matter



## Continuous Monitors are intended to:

- Provide improved temporal resolution to better understand the sources and causes of elevated  $PM_{2.5}$  concentrations in the atmosphere
- Facilitate public reporting of  $PM_{2.5}$  air quality
- Reduce site visits and network operation costs
- Implement periodic control strategies

# 5.8 Continuous in situ Monitoring for Particulate Matter



## Continuous Monitors – National Core (NCore)

At least one NCore site in each state and at a minimum must be able to provide the following PM information:

- 1)  $PM_{2.5}$  particle mass using continuous and integrated/filter-based samplers
- 2) Speciated  $PM_{2.5}$
- 3)  $PM_{10-2.5}$  particle mass
- 4) Speciated  $PM_{10-2.5}$

# 5.8 Continuous in situ Monitoring for Particulate Matter



## Continuous Monitors – State and Local Air Monitoring Stations (SLAMS)

- $PM_{10-2.5}$  measurements are only required at SLAMS sites that additionally serve as NCore sites
- SLAMS-only sites do not require continuous  $PM_{10}$  measurements, although continuous  $PM_{2.5}$  measurements are required
- The minimum number of continuous  $PM_{2.5}$  monitors at SLAMS sites depends on the site's Metropolitan Statistical Area classification
- At least half of the  $PM_{2.5}$  samplers at each site must be a continuously monitoring instrument
- At least one required continuous analyzer in each Metropolitan Statistical Area must be collocated with an FRM/FEM/ARM monitor, unless the continuous instrument has already been deemed a FEM or ARM monitor

# 5.9 Automated Federal Equivalent Monitors



Instruments using two different measurement principles have received EPA's approval as equivalent methods (FEM) for PM<sub>1</sub>

- Beta-radiation
- Oscillating pendulum

## Beta Attenuation Monitor (BAM)

- Monitor samples at ambient conditions of temperature, relative humidity, and gas concentration to minimize particle volatilization biases
- Low-energy, electron-emitting beta rays from a radioactive source are focused on sample deposits on a filter tape and detected on the opposite side
- Beta intensity is described, to a good approximation, by the Beer-Lambert relationship



# 5.9 Automated Federal Equivalent Monitors

## Beta Attenuation Monitor (BAM)

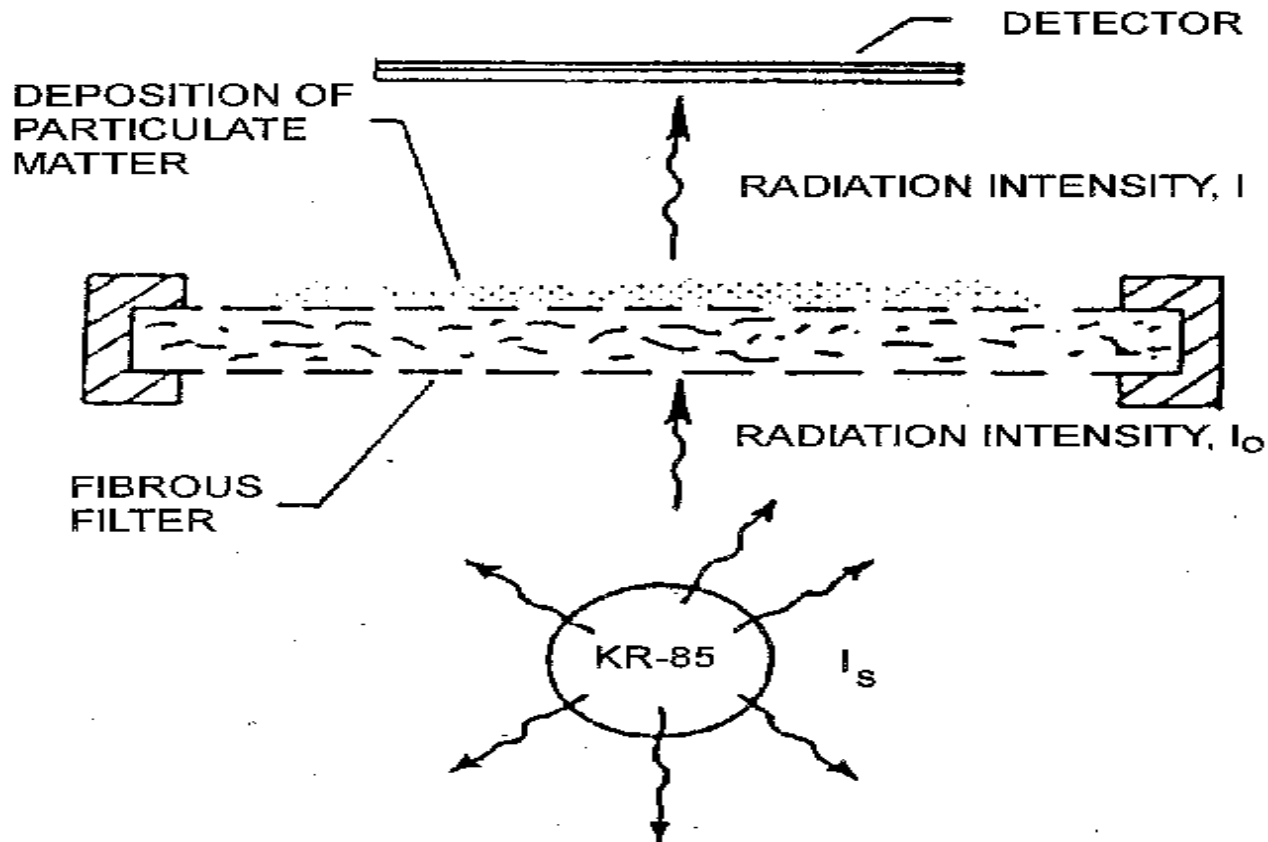

Measurement principle of beta attenuation analyzers



# 5.9 Automated Federal Equivalent Monitors

## Tapering Element Oscillating Microbalance (TEOM<sup>®</sup>)

- Primary operating mechanism is the microbalance system, which relies upon changes in the frequency of an oscillating tapered element to determine changes in the particulate mass collected

$$\omega = \left( \frac{k}{m} \right)^{0.5}$$

Where:  $\omega$  = the angular frequency,  
 $k$  = the restoring force constant, and  
 $m$  = the oscillating mass

Details regarding the operation, calibration, and maintenance at

<http://www.epa.gov/ttn/amtic/inorg.html>.

# 5.10 Other Automated PM Methods



Other automated methods have been developed and used in order to better characterize particulate matter

## **Purposes include:**

- Outdoor and indoor air monitoring
- Industrial hygiene
- Personal exposure assessment

*Guidance for Using Continuous Monitors in PM<sub>2.5</sub> Monitoring Networks (March 3, 1998)*

URL: <http://www.epa.gov/ttnamti1/files/ambient/pm25/r-98-012.pdf>



# 5.10 Other Automated PM Methods

## Mass and Mass Equivalent

- Particle mass is determined by its inertia, electron attenuation properties, or by the decrease in pressure across small pores in a filter. Two types

### Piezoelectric Microbalance

- Piezoelectric crystals have mechanical resonances that can be excited by applying an alternating electrical voltage
- Monitoring the resonance frequency in comparison with a second crystal, one can continuously measure the mass deposited on the crystal

### Pressure Drop Tape Sampler (CAMMS)

- Based on measuring the pressure drop across a porous Fluoropore membrane filter
- Consists of:
- Fluoropore filter tape to collect particles
  - Filter tape transportation system to allow for several weeks of unattended particle sampling
  - System to measure the pressure drop across the filter
  - Diffusion dryer to remove particle-bound water
  - Air sampling pump



# 5.10 Other Automated PM Methods

## Visible Light Scattering

- Illuminating particles, individually or as a group, and measuring the scattered intensity at different orientations from the incident light source.

Five types of instruments:

### **Nephelometers - Quantify Particle Light Scattering**

Applications include:

- Measurements of Rayleigh scattering coefficients
- Determination of aerosol size distributions and refractive indices
- Detection of sulfuric acid - ammonium sulfate aerosol
- Estimation of particle mass concentrations

### **Optical Particle Counter (OPC)**

- Use light scattering to detect the size and number of individual particles
- Used in aerosol research
- Accuracy depends on particle composition and shape

# 5.10 Other Automated PM Methods



## Visible Light Scattering

### Condensation Nuclei Counter (CNC)

- Sense ultrafine particles by causing them to grow to a size that is efficiently detected by light scattering
- The most practical instruments for determining ultrafine particle concentrations
- Not as accurate as other continuous methods for determining PM<sub>2.5</sub> or larger size fraction

### Aerodynamic Particle Sizer (APS)

- Measures light scattering as well as the time-of-flight of sampled particles
- Accelerates the air stream in a converging nozzle
- Particles with higher mass achieve lower velocities than those with lower mass
- Nonspherical particles behave differently from spherical particles, necessitating additional adjustments
- Phantom particle counts may result from the time-of-flight laser detection system

# 5.10 Other Automated PM Methods



## Visible Light Scattering

### Light Detection and Ranging (LIDAR)

- Measures light scattered in the direction of the light source (“backscattering”) along a sight path
- Aerosol LIDAR determines aerosol distributions
- Differential Absorption LIDAR (DIAL) measure concentrations of several gases
- Several types of LIDAR are currently in-use:
  - Basic single-wavelength aerosol
  - High-spectral-resolution and Raman

# 5.10 Other Automated PM Methods



## Visible Light Absorption

- Black carbon (BC) is the dominant visible light-absorbing particulate species in the troposphere and mostly results from anthropogenic combustion sources
- Attenuation of light through a filter and photo-acoustic oscillation are detection principles used to quantify particle absorption as a surrogate for black carbon
- Three types of Instruments are used:

## Aethalometer

- Light-absorbing aerosol (e.g., BC) deposited on a filter can be quantified through the measurement of light transmission or reflection
- Integrating sphere method
- Integrating plate method





# 5.10 Other Automated PM Methods

## Visible Light Absorption

### Particle Soot /Absorption Photometers (PSAP)

- Gives a filter-based, real-time measurement of aerosol light absorption
- Produces a continuous measurement of absorption by monitoring the change in transmittance across a filter for two areas on the filter, a particle deposition area and a reference area

### Photoacoustic Spectroscopy

- Electromagnetic energy absorbed by particles changes to thermal energy, thereby heating the particles and the surrounding gases
- When the light source power is modulated, the periodic expansion of the gas results in a sound wave at the modulation frequency, which may be detected with a microphone

# 5.10 Other Automated PM Methods



## Electrical Mobility

- Analyzers are applicable to particles smaller than 1  $\mu\text{m}$
- Only practical alternative to the Condensation Nuclei Counter (CNC) instrument for quantifying the ultrafine fraction of the particle size distribution

### Consists of:

- Charger to impart an electric charge to the particles
- Classifier that separates the particles by acting on their electrical charge and mass
- Detector to monitor the separated particles

### Two different instruments used:

- Electrical Aerosol Analyzer (EAA)
- Differential Mobility Particle Sizer (DMPS)

# 5.10 Other Automated PM Methods



## Chemical Components

Most chemical-specific particle monitors are currently experimental, rapid technology advances will make them more available and more widely used within coming years

### Single Particle Mass Spectrometers

- *Measure the size and chemical composition of individual particles*
- *Laser Microprobe Mass Spectrometer (LAMMS) have been developed as:*
  - *Rapid Single particle Mass Spectrometer (RSMS)*
  - *Particle Analysis by Laser Mass Spectrometry (PALMS)*
  - *Aerosol Time Of Flight Mass Spectrometry (ATOFMS)*

### Carbon Analyzer

### Sulfur Analyzer

### Nitrate Analyzer



# 5.10 Other Automated PM Methods

## Multi-Elemental Analyzer

### Streaker

- Ambient particles are collected on two impaction stages and an after-filter

First impaction stage has a 10- $\mu\text{m}$  cut point and collects particles on an oiled frit that does not move

Second impaction stage has a 2.5- $\mu\text{m}$  cut point and collects coarse particles ( $\text{PM}_{10}$  minus  $\text{PM}_{2.5}$ ) on a rotating Kapton substrate that is coated with Vaseline to minimize particle bounce

### DRUM

- Davis Rotating-drum Universal-size-cut Monitoring Impactor (DRUM) is an eight-stage cascade impactor

Collects particles on grease-coated mylar substrates that cover the outside circular surface of eight clock-driven slowly rotating cylinders or drums (one for each stage)

# Chapter 5

## Methodologies and Instrumentation for Particulate Matter Sampling



# Questions?

# Chapter 6

## Gaseous Sampling



---

APTI 435: Atmospheric Sampling Course



# Terminal Learning Objective



- At the end of this chapter, the student will be able to describe the absorption and adsorption process and the devices used that affect collection efficiency.

# Enabling Learning Objectives



- 6.1 Summarize the operating principles of absorption when sampling gaseous pollutants.
- 6.2 Identify the types of absorption and the factors affecting collection efficiency.
- 6.3 Determine the methods of collection efficiency.
- 6.4 Summarize the operating principles of absorption when sampling gaseous pollutants.



# Enabling Learning Objectives (cont)



- 6.5 Identify the types of absorption and the factors affecting collection efficiency.
- 6.6 Determine the methods of collection efficiency.
- 6.7 Summarize the operating principles of adsorption when sampling gaseous pollutants.

# 6.1 Principles of Absorption



## Introduction:

Absorption is the process “of transferring one or more gaseous components into a liquid or solid medium in which they dissolve.”

## Methods Include:

- Photometric
- Conductimetric
- Titrimetric Techniques

# 6.1 Principles of Absorption



## Types of Absorption:

### Gas-Liquid Absorption

### Gas-Liquid Absorption Sampling

- Physical Absorption
- Chemical Absorption

# 6.1 Principles of Absorption



## Physical Absorption

Solubility of selected gases in distilled water at 20°C

Gas	Volume absorbed per volume of water*
Nitrogen	0.015
Oxygen	0.031
Nitric oxide	0.047
Carbon dioxide	0.878
Hydrogen sulfide	2.582
Sulfur dioxide	39.374

\*Gas volumes reduced to 0°C and 760 mm Hg.

# 6.1 Principles of Absorption



## Chemical Absorption:

Involves a liquid absorbent that reacts with the pollutant to yield a nonvolatile product.

The solvent selected is one that reacts with the pollutant in an irreversible fashion

Primary factors affecting the choice of an absorbent in chemical absorption are the solubility of the pollutant, reactive properties of pollutant and absorbent, and the subsequent analytical method to be used.

Automated continuous equivalent method (e.g. UV Fluorescence) which provides real-time data would be used.

# 6.2 Collection Efficiency



- **Factors Affecting Collection Efficiency**
- **Absorber Characteristics**
- **Chemical Characteristics**
- **Physical Characteristics**

# 6.3 Determination of Collection Efficiency

## Absorption Devices

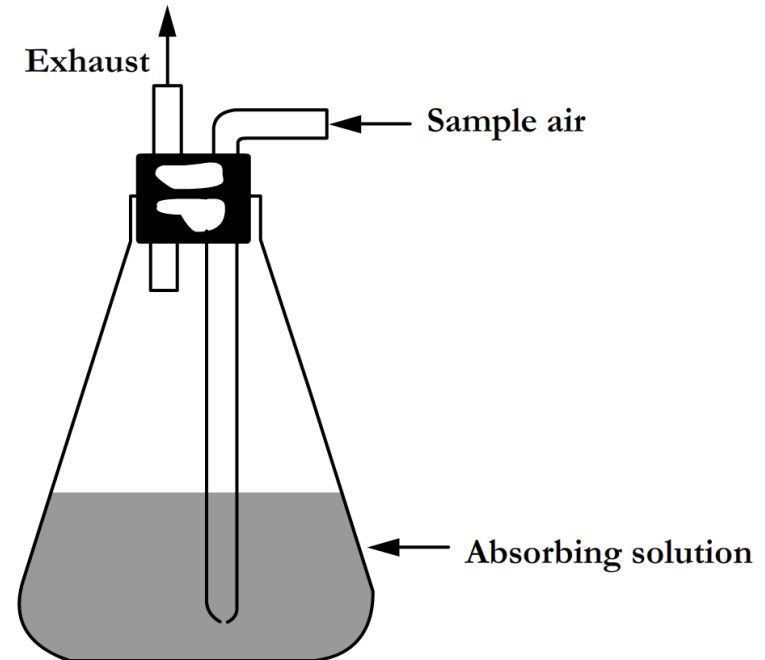

Absorption device adapted from an Erlenmeyer flask.

# 6.3 Determination of Collection Efficiency



## Fritted-Glass Absorbers

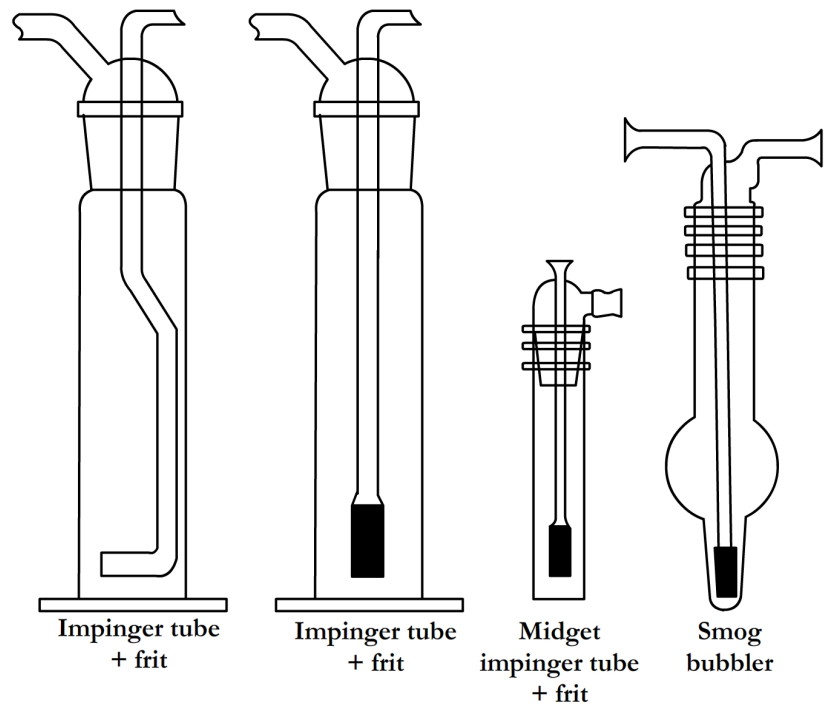

Typical fritted-glass absorbers



# 6.3 Determination of Collection Efficiency



## Absorption Sampling Devices

Principle of operation	Devices	Capacity (ml)	Sampling rate (L/min)	Efficiency * (%)	Comments
Simple gas-washing bottles. Gas flows from unrestricted opening into solution. Glass conical or cylindrical shape.	Standard	125–500	1–5	90–100	Bubblers are large. Reduction of sampling rate increases efficiency. Several units in series raises efficiency.
	Drechsel	125–500	1–5	90–100	Similar to above.
	Fleming	100	1–5	90–100	Difficult to clean.
Modified gas-washing bottles.	Fritted bubbler	100–500	1–5	95–100	Fritted tubes available for simple gas washing, items above. Smaller bubblers provide increased gas-liquid contact.
	Glass bead bubbler	100–500	1–5	90–100	Provides for longer gas-liquid contact, smaller bubbles.

# 6.3 Determination of Collection Efficiency

## Absorption Sampling Devices (cont)

Principle of operation	Devices	Capacity (ml)	Sampling rate (L/min)	Efficiency * (%)	Comments
Large bubbler traverses path extended by spiral glass insert.	Fisher Milligan bottle	275	1-5	90-100	
	Greiner-Friedrichs	100-200	1-5	90-100	Similar to Fisher Milligan.
Impingers – designed principally for collection of aerosols. Used for collection of aerosols.	Greenburg-Smith	500	1-5	90-100	Cylindrical shape.
Used for collection of gases. Restricted opening. Fritted tubes available which allow use of a bubbler.	Midget	100	0.1-0.5	90-100	
Smog bubbler.	Fritted bubbler	10-20	1-4	95-100	



# 6.3 Determination of Collection Efficiency



## Impingers

Two Types of Impingers

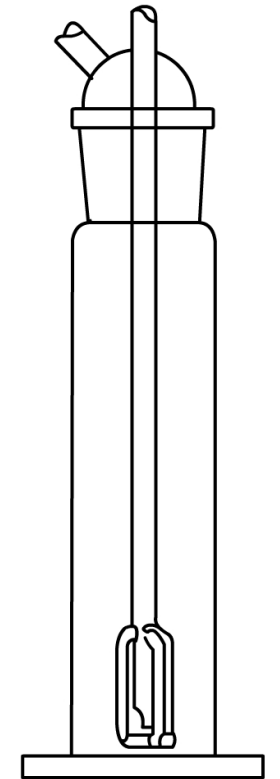

Greeburg - Smith

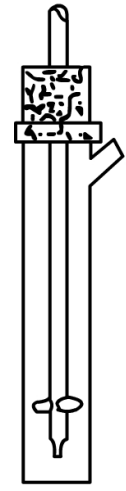

Midget

# 6.4 Principles of Adsorption



## Basic Principles

- Adsorption is the phenomenon by which gases, liquids, and solutes within liquids are attracted, concentrated, and retained at a boundary surface
- A solid adsorbent has a crystal lattice structure
- Unbalanced Condition
- Adsorbate versus Adsorbent

# 6.4 Principles of Adsorption (cont)



## Types of Adsorption

- Physical or Van der Waals' adsorption (physiosorption)
- Chemical Adsorption (chemisorption)

## Physical Adsorption

- The attractive forces consist of Van der Waals' interactions, dipole-dipole interactions, and/or electrostatic interactions
- Commonly occurring process

## Chemical Adsorption

- Characterized by high heats of adsorption

# 6.4 Principles of Adsorption (cont)



## Variables Affecting Gas Adsorption

**The quantity of a particular gas that can be adsorbed by a given amount of adsorbent will depend on the following factors:**

1. concentration of the gas in the immediate vicinity of the adsorbent
2. the total surface area of the adsorbent
3. the temperature of the system
4. the presence of other molecules competing for a site on the adsorbent
5. the characteristics of the adsorbate such as weight, electrical polarity, and chemical reactivity

# 6.4 Principles of Adsorption (cont)



## Adsorption Isotherms

- The description of the relationship between the quantity of gas adsorbed at various concentrations or pressures at constant temperature is called an adsorption isotherm
- An adsorption isotherm consists of a plot of the data obtained from measuring the amount of gas adsorbed at various gas concentrations or pressures at equilibrium under a condition of constant temperature.
- Adsorption isotherms are useful in that they provide a means of evaluating:
  - (a) the quantity of gas adsorbed at various gas concentrations
  - (b) adsorptive capacities at various gas concentrations
  - (c) the adsorptive capacity as a function of concentration and type of gas
  - (d) the surface area of a given amount of adsorbent

# 6.4 Principles of Adsorption (cont)



## Types of Adsorption Isotherms

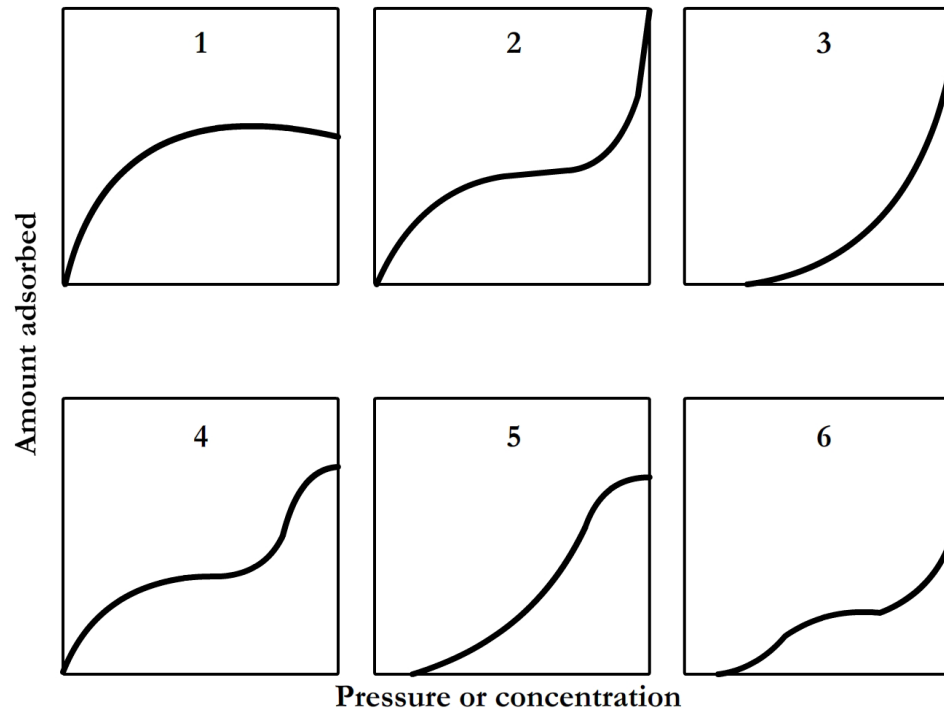

Figure 6-4. Gas adsorption isotherms.



# 6.4 Principles of Adsorption (cont)



## Types of Adsorption Isotherms (cont)

**Type 1** – This type represents the adsorption of a single layer of gas molecules on the adsorbent. There is no interaction between the adsorbed molecules.

**Type 2** – This isotherm begins like Type 1 but is modified at high pressure by multilayer adsorption. There is definite interaction between the layers of adsorbed gas molecules.

**Type 3** – This type of isotherm is rare. It occurs only when initial adsorption favors a very few strong sites. The interaction between adsorbed molecules is so strong that vacant sites next to occupied sites are stronger than any other vacant sites. In this type of adsorption the number of effective sites increases with coverage of the adsorbent.

**Types 4 and 5** – These two are similar to Types 2 and 3 respectively, except that they continue to exhibit adsorption at high adsorbent coverage.

**Type 6** – This type resembles Type 5 with monolayer adsorption first and then continued deposition of a multilayer film.

# 6.4 Principles of Adsorption (cont)



## Adsorbate Characteristics

The major adsorbate characteristics affecting the amount of gas adsorbed are the ease of liquefaction of the gas, adsorbate size, concentration of the gas, and presence of other gases.

# 6.4 Principles of Adsorption (cont)



## Gas Liquefaction

Table 6-3. Adsorption of gases on one gram of charcoal at 15°C.\*

Gas	Volume adsorbed (cc)	Critical temperature (K)
H <sub>2</sub>	4.7	33
N <sub>2</sub>	8.0	126
CO	9.3	134
CH <sub>4</sub>	16.2	190
CO <sub>2</sub>	48.0	304
HCl	72.0	324
H <sub>2</sub> S	99.0	373
NH <sub>3</sub>	181.0	406
Cl <sub>2</sub>	235.0	417
SO <sub>2</sub>	380.0	430

\*Volumes of gases have been reduced to standard conditions (0°C and 1 atmosphere pressure).

# 6.4 Principles of Adsorption (cont)



## Adsorbate Size

- Characterized by a lower and upper range
- The lower size limit is imposed on physical adsorption by the requirement that the pollutant must be higher in molecular weight than the normal components of air
- Gases with molecular weights greater than 45 are readily removed by physical adsorption
- Gases of interest of lower molecular weight, such as formaldehyde and ammonia, may be removed by chemical adsorption methods using appropriately impregnated adsorbents
- Brownian motion, or kinetic velocities

# 6.4 Principles of Adsorption (cont)



## Gas Concentration

- The quantity of gas adsorbed is a function of the gas concentration or pressure.
- An increase in concentration or pressure in the vicinity of the adsorbent results in an increase of the total amount of gas adsorbed.

# 6.4 Principles of Adsorption (cont)



## Presence of Other Gases

- Since the presence of additional gas molecules in a particular adsorbent-adsorbate system causes competition for the limited number of adsorption sites present, the observed effect is a reduction in the amount of adsorbate removed.

# 6.4 Principles of Adsorption (cont)



## Adsorbent Characteristics

- Granular in form and are supported in a column through which the gas to be sampled is drawn.
- Common adsorbents have the capacity to adsorb 8 to 40% of their weight.
- An ideal adsorbent should be granular and of such size and form that it offers little or no resistance against flow.
- It should have a high adsorptive capacity; be inert and specific; be resistant to breakage, deterioration, and corrosion; be easily activated; and provide an easy release of adsorbate.

# 6.4 Principles of Adsorption (cont)



## Surface Area

- Large surface areas are desirable for extensive adsorption
- Adsorption is a surface phenomenon, it is not very pronounced unless the adsorbent possesses a large surface area for a given mass
- Materials like silica gel and charcoals obtained from wood, bone, coconut shells, and lignite are very effective adsorbing agents

Adsorbent	Area (m <sup>2</sup> /g)
Clay	5 – 15
Asbestos	10 – 20
Chalk	20 – 30
Carbon black	50 – 100
Silica or alumina gel	200 – 800
Activated carbon	500 – 2000

**Table 6-4. Typical surface areas of adsorbents.**



# 6.4 Principles of Adsorption (cont)



## Pore Size

- The pore size in the more porous adsorbents may vary in diameter from a few to several hundred angstrom units
- This may become a critical factor in selecting an adsorbent to remove a particular adsorbate.

# 6.4 Principles of Adsorption (cont)



## Chemical Nature

- Chemical nature of the adsorbent's surface is an additional factor of considerable importance.
- In Chemical Adsorption, where a rapid rate and a large degree of chemical reaction are desirable
- In Physical Adsorption the nature of the surface is one of the primary factors influencing the strength of the adsorbent-adsorbate attraction

# 6.4 Principles of Adsorption (cont)



## Typical Adsorbents

- Adsorbents used in physical adsorption may be classified according to their degree of polarity
- Non-polar adsorbents are most effective for gross decontamination of moist air streams containing materials of little polarity
- The majority of the commercially important adsorbents other than carbon derivatives are simple or complex oxides
- Their surfaces consist of heterogeneous distributions of charge on a molecular scale and are strongly polar in nature

# 6.4 Principles of Adsorption (cont)



## Carbon

- Various forms of carbon serve as efficient adsorbents
- Carbon prepared from harder, denser materials such as peach and other fruit pits, and coconut shells have the highest adsorptive capacities
- Primary carbon is not nearly as efficient as activated carbon
- Activated carbon has a high adsorptive capacity, a high degree of hardness, high reliability, and other premium qualities



# 6.4 Principles of Adsorption (cont)

## Carbon (cont)

- It will not adsorb very well are low molecular weight gases such as oxygen, nitrogen, and carbon monoxide
- Activated carbon finds its major application in solvent recovery and odor removal
- Activated carbon is perhaps the most widely used adsorbent in air pollution control

acetic acid	iodine
benzene	carbon disulfide
ethyl alcohol	diethyl ether
carbon tetrachloride	ammonia
methyl alcohol	hydrochloric acid
chloroform	nitrous oxide
acetone	carbon dioxide
acetaldehyde	noble gases
mercury vapor	PVC

Substances are some of those that have been shown to be appreciably adsorbed upon activated carbon

# 6.4 Principles of Adsorption (cont)



## Molecular Sieve

- Molecular sieve adsorbents are synthetic sodium or calcium alumino-silicate zeolites of very high porosity
- They are another representative of the siliceous adsorbents  
Often referred to as molecular sieve adsorbents
- Molecular sieves can be made very specific with respect to pore size - an outstanding property of being specific on the basis of adsorbate size and shape
- Molecular sieves show a strong preference for the more polar molecules
- Truly selective adsorbents because they can separate mixtures on the basis of differences in molecular size, degree of polarity, and extent of carbon bond saturation

# 6.4 Principles of Adsorption (cont)



## Molecular Sieve (cont)

- Possess a high adsorptive capacity over wide ranges of concentration and temperature
- Capable of removing impurities to extremely low concentrations
- Tested successfully on carbon dioxide, hydrogen sulfide, acetylene, ammonia, and sulfur dioxide
- Unlike carbon, they can be used to effectively adsorb compounds of low molecular weight

# 6.4 Principles of Adsorption (cont)



## Adsorption Losses in Air Sampling

The problems most frequently encountered are:

1. Irreversible Adsorption
2. Variable Desorption Efficiency
3. Interference by Water Vapor



# 6.4 Principles of Adsorption (cont)



## Current Applications of Adsorption in Atmospheric Sampling

- Carbon, porous polymers such as Porapak Q, Porapak P, Tenax GC, XAD-resins, and polyurethane foam have been used extensively in collecting pesticides, polychlorinated biphenyls, and other organic compounds in ambient air

# 6.4 Principles of Adsorption (cont)



## Current Applications of Adsorption in Atmospheric Sampling (cont)

Here polyurethane foam is used to collect organics, namely PCBs.

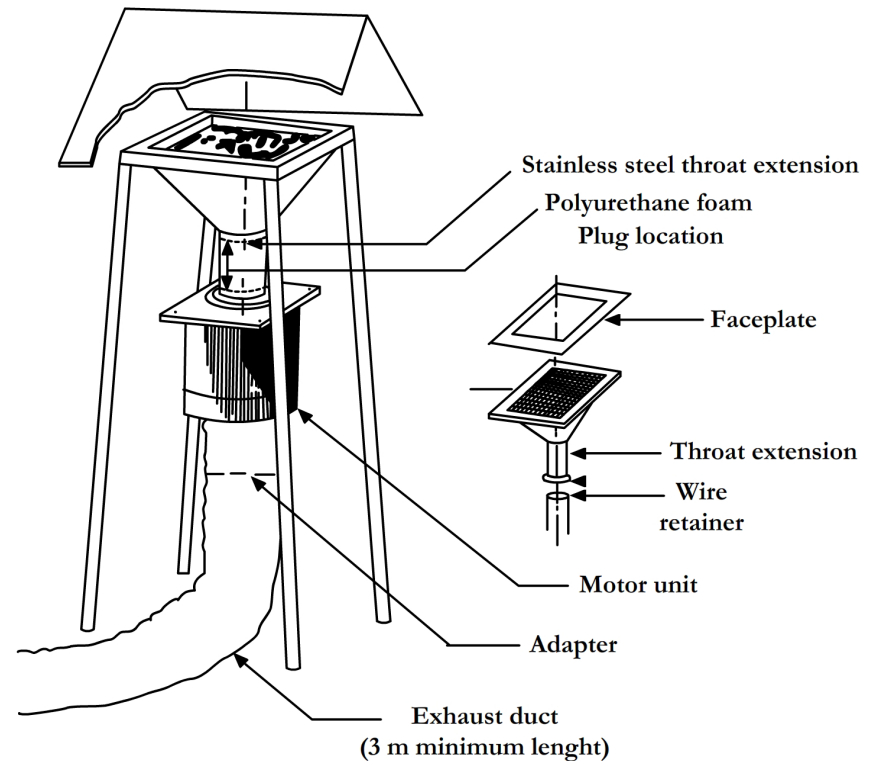

Figure 6-5. Assembled sampler and shelter with exploded view of the filter holder.

# 6.4 Principles of Adsorption (cont)



- **Current Applications of Adsorption in Atmospheric Sampling (cont)**

An Adsorbent Sampling Cartridge

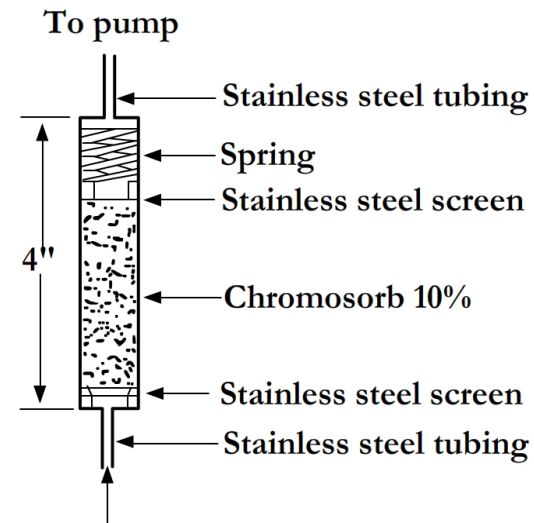

Figure 6-6. High-speed organic vapor collector.

# 6.4 Principles of Adsorption (cont)

- **Current Applications of Adsorption in Atmospheric Sampling (cont)**

Cartridge placed in a thermal desorption system

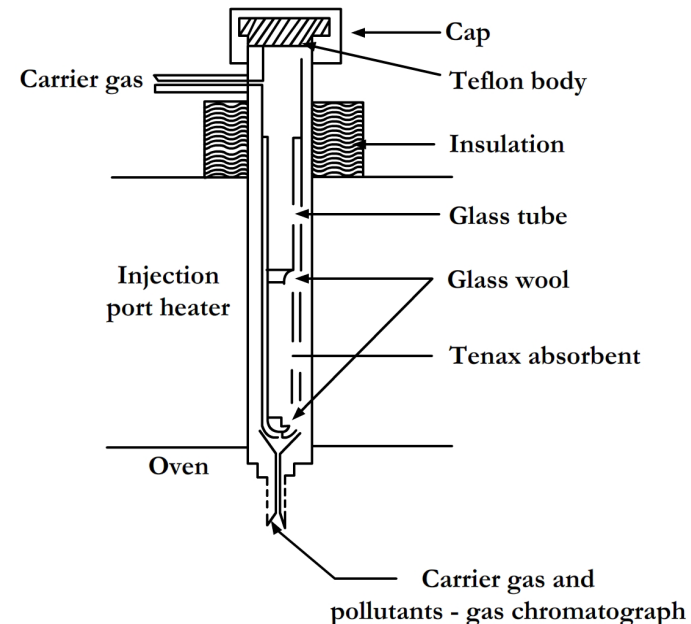

Figure 6-7. Desorption of pollutants from a Tenax-GC cartridge.

# 6.4 Principles of Adsorption (cont)



- **Current Applications of Adsorption in Atmospheric Sampling (cont)**

Dynamic Enrichment, which is repeated absorption from many different cartridges onto a single cartridge to attain enough of the species of interest for measurement

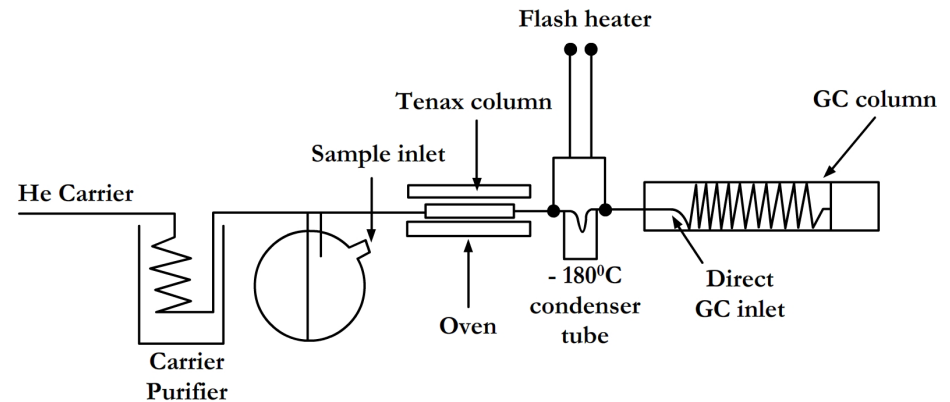

Figure 6-8. Dynamic enrichment on adsorption column (experimental setup).

# 6.5 Selection and Performance of Wet Collector Media



## Introduction

- In the design of sampling trains, the most important component of the entire system is the collector
- The collector may take the form of a bubbler, impinger, etc.
- Using a Wet Collector (Absorber) - important factors to consider are:
  1. Solubility of Pollutant
  2. Rate of Reaction
  3. Collection Efficiency
  4. Retention Characteristics of Absorbant.

# 6.5 Selection and Performance of Wet Collector Media (cont)



## Solubility of Pollutant

- Solubility of a pollutant in a solvent must be considered in determining the type of absorber to choose
- Also determine the conditions under which the sample will be taken
- The absorption coefficient is one method employed to express the results of solubility measurements with gases

# 6.5 Selection and Performance of Wet Collector Media (cont)



## Solubility of Pollutant (cont)

Table 6-5. Absorption coefficient of gases at 20°C.\*

Solvent	H <sub>2</sub>	He	N <sub>2</sub>	O <sub>2</sub>	CO	CO <sub>2</sub>	NO	H <sub>2</sub> S	NH <sub>3</sub>
Water	.017	.009	.015	.028	.025	.88	.047	2.68	710
Carbon disulfide	.031	—	.049	—	.076	.83	—	—	—
Chloroform	—	—	.120	.205	.177	3.45	—	—	—
Ethyl alcohol	.080	.028	.130	.143	.177	3.0	—	—	—
Acetone	.065	.030	.129	.207	.198	6.5	—	—	—
Ethyl ether	.12	—	.24	.415	.38	5.0	—	—	—
Benzene	.066	.018	.104	.163	.153	—	—	—	—

\*Glasstone S. 1946. Textbook of physical chemistry. New York: D. Van Nostrand, p. 695.



# 6.5 Selection and Performance of Wet Collector Media (cont)



## Solubility of Pollutant (cont)

### Influence of Temperature

**Table 6-6. Influence of temperature on solubilities of gases in water.\***

<b>Gas/temp</b>	<b>Helium</b>	<b>Nitrogen</b>	<b>Oxygen</b>	<b>Carbon Dioxide</b>
0°C	.0094	.0235	.0489	1.713
30°C	.0081	.0134	.0261	.665

\*Glasstone 1946, p. 696.

# 6.5 Selection and Performance of Wet Collector Media (cont)



## Rate of Reaction

- Chemical reactions take place at a definite rate, depending on process conditions
- The most important factors are concentration of reactants, temperature, and presence of a catalyst or inhibitor
- Some reactions are so rapid that they appear to be instantaneous
- Others are so slow at ordinary temperatures that no detectable change would be observed in the course of years
- Rate of a reaction is proportional to the concentration of the reacting substances

# 6.5 Selection and Performance of Wet Collector Media (cont)



## Collection Efficiency

- There are three major factors inherent in the design of a bubbler that can affect the efficiency of the absorber:
  1. Bubble Size
  2. Flow Rate
  3. Height of Liquid Column

# 6.5 Selection and Performance of Wet Collector Media (cont)



## Collection Efficiency (cont)

- Flow Rate (cont)

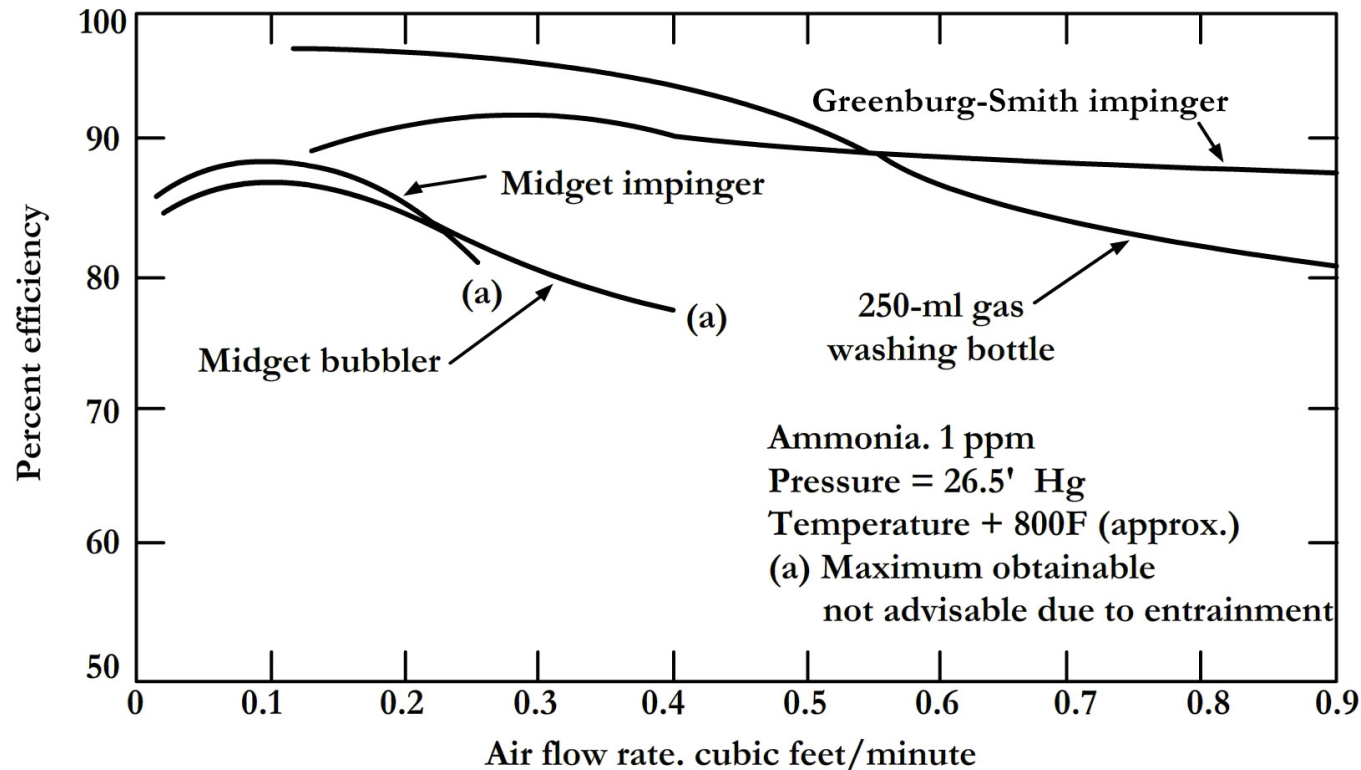

Figure 6-9. Performance curves - commercially available absorbers.

# 6.5 Selection and Performance of Wet Collector Media (cont)



## Retention Characteristics of Absorbant (Solvent)

Raoult's Law Equation:  $p = Np_o$

*Where:  $p$  = partial pressure of gas to be dissolved (atm)*

*$N$  = mole fraction of gas*

*$p_o$  = vapor pressure of gas (atm)*

# 6.5 Selection and Performance of Wet Collector Media (cont)



## Retention Characteristics of Absorbant (Solvent) (cont)

Table 6-8. Ideal and observed solubilities at 20°C.

<b>Gas</b>	<b>Ideal</b>	<b>Nitrobenzene</b>	<b>Ethyl alcohol</b>	<b>Aniline</b>	<b>Water</b>
Nitrogen	10	2.6	3.3	1.1	0.13
Carbon dioxide	11	3.9	4.5	1.9	0.19
Oxygen	16				0.17
Argon	21		6.5		0.17

# 6.5 Selection and Performance of Wet Collector Media (cont)



## Retention of Gases and Vapor by Chemical Reaction

- The usual objective in the selection of an absorbent for scrubbing a gas is to find a liquid, possibly a solution, with a very large capacity for absorbing the solute without building up an appreciable equilibrium back pressure
- This can be accomplished readily by choosing a chemical with which the solute reacts irreversibly, as when an aqueous solution of sodium hydroxide is used to absorb carbon dioxide

# 6.5 Selection and Performance of Wet Collector Media (cont)



## Retention of Gases and Vapor by Chemical Reaction (cont)

- Whenever there is a pronounced chemical reaction occurring simultaneously with absorption, there are essentially two effects that must be considered:
  1. Modification of Capacity (Rate) Data
  2. Modification of the Driving Force



# 6.5 Selection and Performance of Wet Collector Media (cont)



## Retention of Particulate Matter

- The design of the absorber plays a most important part in the retention of particulate matter by a liquid
- A liquid absorber is highly efficient for retaining particles only when the velocity of the air at the jet approaches that of sound and the particles impinge with high velocity on a surface in the liquid
- The sudden change in kinetic energy results in the virtually complete trapping of all particles having a diameter greater than 1 micrometer

# 6.6 Principles of Grab Sampling

## Introduction



- The term “Grab Sample” suggests two concepts
  - (a) A sample taken at a particular time and place within an interval of a few seconds to a minute or two, and
  - (b) A small representative portion removed from the gross sample with no alteration
- Grab Sampling is often referred to as “Whole Air Sampling”
- Grab Samples are usually collected in one of the following ways:
  - (a) Using an Evacuated Container
  - (b) Purging (displacement of air)
  - (c) Displacement of a Liquid
  - (d) Inflation of a Plastic Bag
  - (e) Using a Syringe

# 6.6 Principles of Grab Sampling (cont)



## Evacuated Containers

Evacuated containers used for grab sampling include:

1. Stainless Steel Containers
2. Vacuum Tubes (glass)
3. Vacuum Flasks (glass)

# 6.6 Principles of Grab Sampling (cont)



## Sampling with Canisters

Verify Initial Vacuum of the Canister (typical for Air Toxics LTD Canisters):

- a. Confirm the valve is closed
- b. Remove the brass cap
- c. Attach pressure gauge and cap side fitting with brass cap
- d. Open and close valve quickly (a few seconds)
- e. Read vacuum on the gauge and record on data sheet

# 6.6 Principles of Grab Sampling (cont)



## Sampling with Canisters (cont)

Grab Sample Procedure (typical):

- a. Confirm the valve is closed
- b. Remove brass cap
- c. Attach particulate filter to canister
- d. Open valve  $\frac{1}{2}$  turn
- e. Close valve
- f. Verify and record final vacuum (repeat steps for initial vacuum verification)
- g. Replace brass cap
- h. Ensure Chain of Custody documents are completed
- i. Send canister for analysis

# 6.6 Principles of Grab Sampling (cont)



## Evacuated Containers

Evacuated containers used for grab sampling include:

1. Stainless Steel Containers
2. Vacuum Tubes (glass)
3. Vacuum Flasks (glass)

# 6.6 Principles of Grab Sampling (cont)



## Precautions for Integrated Sampling with Canisters

- Avoid Leaks in the Sampling Train
- Monitor Sampling Progress
- Avoid Contamination
- Caution Against Sampling in Extreme Temperatures

# 6.6 Principles of Grab Sampling (cont)



## Vacuum Tube

- One common type is a strong glass tube of 250 to 300 ml capacity, although tubes with volumes as large as 1 to 2 liters are sometimes used

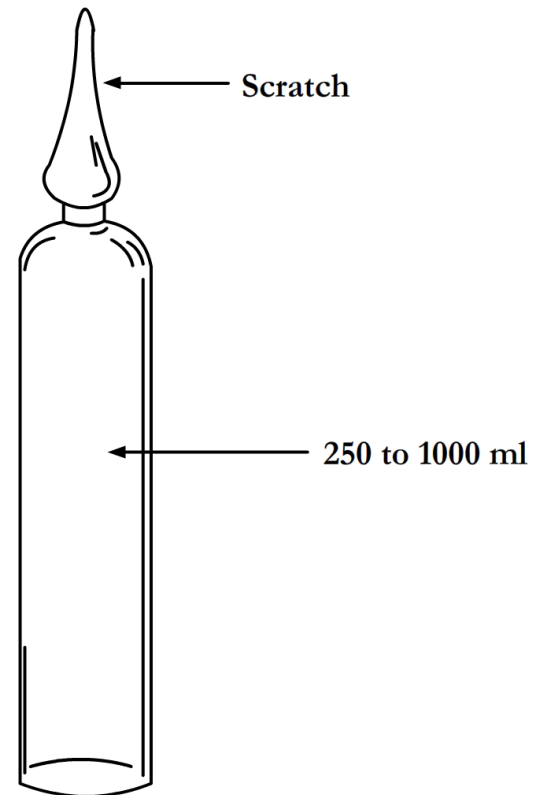

Figure 6-10. Vacuum tube.



# 6.6 Principles of Grab Sampling (cont)



## Evacuated Flask

- An evacuated flask fitted with a stopcock or vacuum cap can also be used in this type of sampling

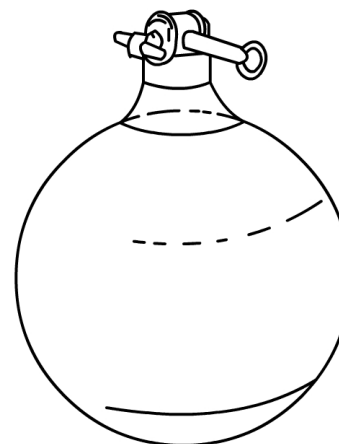

Figure 6-11. Vacuum flask.

# 6.6 Principles of Grab Sampling (cont)



## Air Displacement or Purging

- Cylindrical tubes with stopcocks at each end are used as collectors
- The stopcocks are opened and the tube is thoroughly purged
- After sampling, the tube should be held in place until the stopcocks have been closed and the aspirating device has been removed

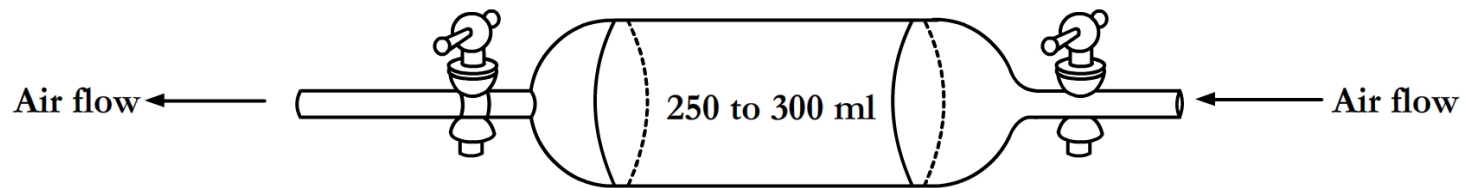

Figure 6-12. Gas-displacement collector

# 6.6 Principles of Grab Sampling (cont)



## Liquid Displacement

- Liquid is allowed to drain from the bottom of a container, while an opening at the top allows the gas to enter and fill the space left by the liquid.
- Any suitable liquid that will not dissolve the sample nor react with it can be used

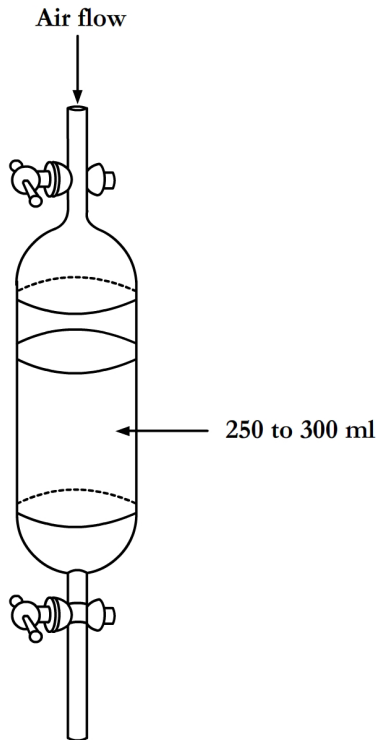

Figure 6-13. Liquid-displacement collector.

Figure 6-14. Aspirator bottle.

# 6.6 Principles of Grab Sampling (cont)



## Inflation – “Plastic Bag” Sampling

Some HAZARDS to look out for in “Bag Sampling:

1. Wall effects
2. Memory effects – where previous constituents linger
3. Sample deterioration over time or due to sunlight
4. Possibly due to reactions among various gases in the bag

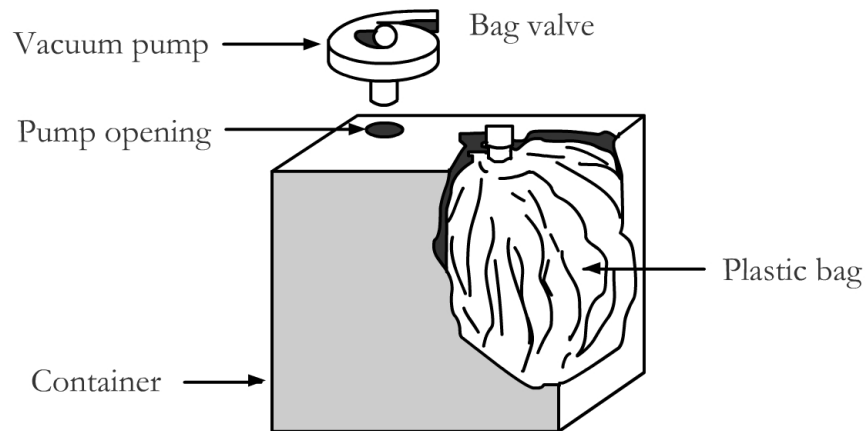

Figure 6-15. Inflation sampler.

# 6.6 Principles of Grab Sampling (cont)



## Inflation – “Plastic Bag” Sampling (cont)

Table 6-9. Comparison of canisters and plastic (Tedlar) bags

	<b>Canisters</b>	<b>Tedlar Bags</b>
<b>Common Volumes</b>	1 and 6 L	1, 3, and 5 L
<b>Type of Sampling</b>	Passive (vacuum)	Active (pump required in field)
<b>Sample Handling</b>	Room Temperature	Room Temperature
<b>Media Hold Time</b>	Up to 30 days	Indefinite
<b>Hold Time to Analysis</b>	Up to 30 days	Up to 3 days
<b>Surface Inertness</b>	Excellent	Fair
<b>Cleanliness</b>	Certified to ppbv/pptv levels	Some VOC's present at 0.5 to 45 ppbv
<b>Sampling Applications</b>	Ambient/indoor air, soil/landfill gas, stationary sources	Ambient/indoor air, soil/landfill gas, stationary sources
<b>“Sensitivity”</b>	“ppbv device”	“ppmv device”
<b>Advantages</b>	Inertness, hold time, ruggedness, no pump needed in field	Purchase/shipping cost, availability, convenience

# 6.6 Principles of Grab Sampling (cont)



## Syringes

- May be used in the collection of small gas samples
- Widely applied in the field of odor measurement

# 6.6 Principles of Grab Sampling (cont)



## Grab Sampling Techniques

- Preferable to continuous sampling in certain situations
- Field conditions such as lack of electricity and lab facilities often necessitate this type of sampling
- Useful when concentrations vary considerably over a period of time and it is necessary to obtain a sample at a specific time
- Serious limitation – the sample is generally not large enough to detect very small quantities of materials except by the most sensitive techniques

# 6.7 Principles of Cryogenic (Freeze-out) Sampling



## Introduction

- Air pollutants existing as gases can be trapped or removed by the freeze-out or condensation method
- Trapping refers to the mechanism of sample collection and removed implies an air-cleaning mechanism to separate gas contaminants from the gas stream
- Method has a very high efficiency at relatively low flow rates



# 6.7 Principles of Cryogenic (Freeze-out) Sampling

## Concept



- Consists of drawing air through collection chambers with progressively lower temperatures
- If the temperatures of the chambers are approximately equal to or less than the boiling point (the temperature at which a liquid is converted to a gas) of the gaseous components of the air passing through it these components will exhibit a phase change from the gaseous phase to the liquid phase
- The condensate (liquid phase) is collected in the chamber where the phase change occurs
- The gaseous contaminants to be collected will determine the temperatures required in the collection chambers
- The temperatures of the chambers can be controlled by using different immersion bath liquids. Contaminants with boiling points as low as  $-195^{\circ}\text{C}$  can be collected by this method

# 6.7 Principles of Cryogenic (Freeze-out) Sampling



## Equipment

- Depends on application
- Amount of equipment depends whether the sampling apparatus is a single or multistage unit
- Collection chamber size varies according to the immersion bath for which it was designed
- Collection chambers placed in Dewar flasks containing the cooling solutions

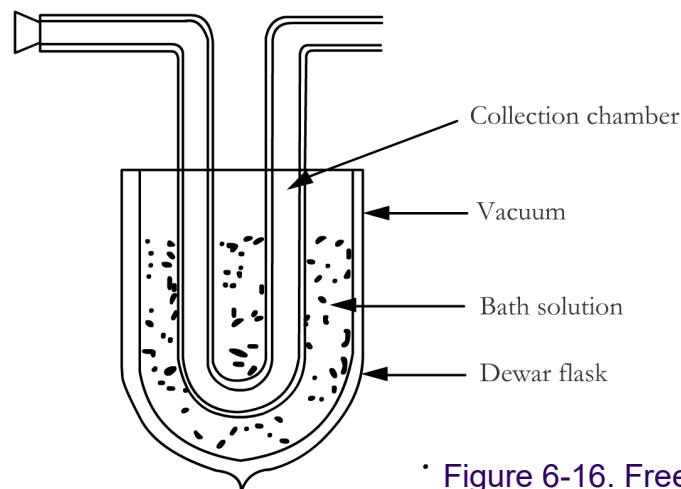

• Figure 6-16. Freeze-out unit.

# 6.7 Principles of Cryogenic (Freeze-out) Sampling



## Equipment (cont)

The volume of the bath solutions and size of the collecting chamber are partially due to factors such as:

- Temperature gradients across the collecting chambers as related to the criticality of the boiling point of the contaminant being collected
- The surface area as related to the evaporation rate of the bath solution
- The condensation of water vapor in the primary collection chambers, thus necessitating a larger volume

Bath solution	Temperature	Volume of solution
Ice & salt	- 16°C	2 liter
Dry ice & acetone or methyl-cellosolve	-80°C	750 ml
Liquid air	147 °C	100 ml
Liquid oxygen	-183°C	100 ml
Liquid nitrogen	-195°C	100 ml

Table 6-9. Bath solutions.

# 6.7 Principles of Cryogenic (Freeze-out) Sampling



**Freeze-out devices can be classified into two categories:**

- **Single-Stage and Multistage Units**

## **Single-Stage Units**

- Consist of one collection chamber (glass or metal) immersed in a bath solution
- Temperature of the bath and the liquid of the bath will depend on the particular gas to be sampled

# 6.7 Principles of Cryogenic (Freeze-out) Sampling



## Multi-stage Units

- Consist of a series of collection chambers
- Can be arranged in either horizontal or vertical trains

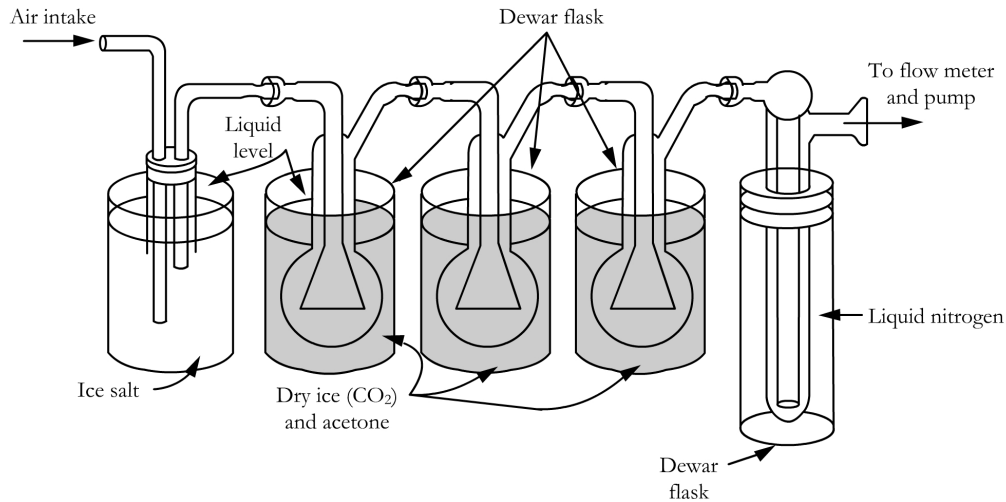

Figure 6-17. Freeze-out equipment for atmospheric sample (horizontal sampling train).

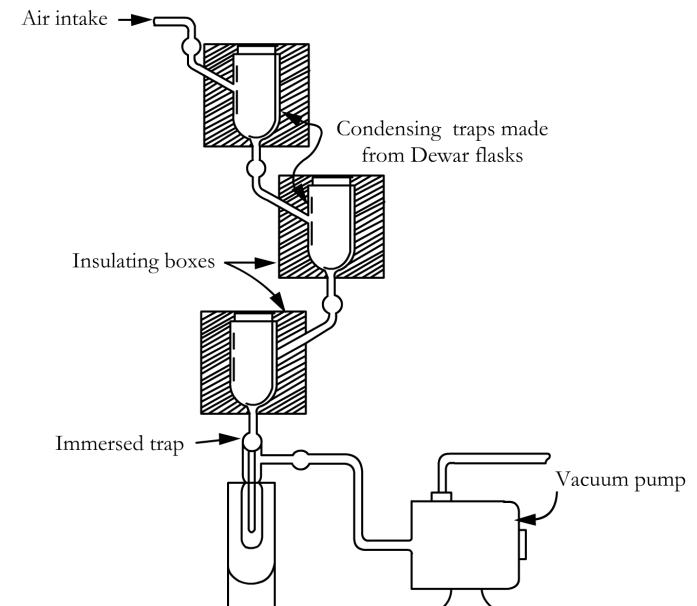

Figure 6-18. Freeze-out equipment for atmospheric samples (vertical sampling train).

# 6.7 Principles of Cryogenic (Freeze-out) Sampling



## Efficiency

- To efficiently condense gases it is necessary for the gas to come in contact with the cold surface of the collection chamber therefore the efficiency of collection by freeze-out can be improved by:
  1. Filling the collection chamber with some type of material that will increase the cold surface area
  2. Reducing the flow rate

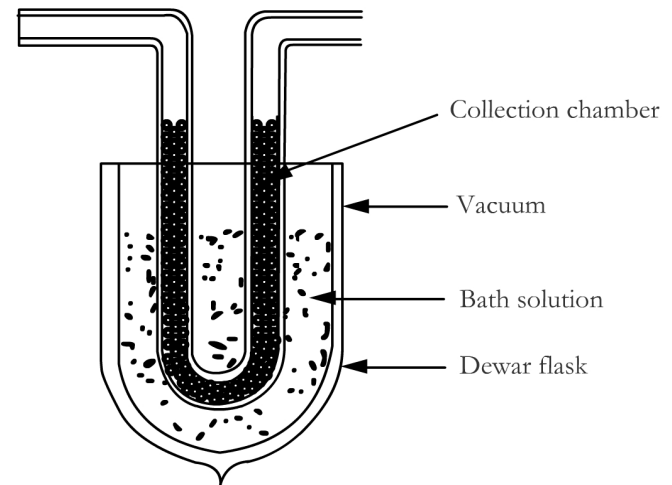

Figure 6-19. Freeze-out unit showing packing material.

# 6.7 Principles of Cryogenic (Freeze-out) Sampling



## Efficiency (cont)

### Flow Rate

- The flow rate through the train should be such that a sufficient detention time is available to allow the desired collection efficiency

### Errors

- One possible source of error is that gases soluble in water will be removed to some extent prior to their removal in a collection chamber

### Sensitivity

- The sensitivity of the freeze-out method depends primarily on the gas collected, volume of air sampled, and how the collected gas is analyzed

### Freeze-out Train

- Trains composed of several collection chambers have the ability of collecting several gases at the same time

### Multi-collection Train

- The major advantage of such a train would be the removal of particles and gases that were not of interest

# Chapter 6

## Gaseous Sampling



# Questions?



# Chapter 7

## Standard Methods for Criteria Pollutants



---

APTI 435: Atmospheric Sampling Course



# Terminal Learning Objective



- At the end of this chapter, the student will be able to identify the standard methods for criteria pollutants.

# Enabling Learning Objectives

- 7.1 Define NAAQS
- 7.2 Identify the standard reference test methods for criteria pollutants

## 7.1 Introduction



# Legislative Amendments and History

- 1970 Amendments to the Clean Air Act (CAA)
- National Ambient Air Quality Standards (NAAQS)
- Air monitoring stations are operated nationwide
- EPA established reference test methods

## 7.2 Reference Method and Equivalent Method



### Reference and Equivalent Methods (R&E) Program

- Program is part of the EPA's Office of Research and Development of the National Exposure Research Laboratory (NERL)
- Methods designated by the R&E Program may be either Manual or Automated
- The distinction between automated reference and equivalent methods is based on the measurement principle that an instrument employs



## 7.2 Reference Method and Equivalent Method

### Criteria Pollutants and Measurement Methods

- The United States has established National Ambient Air Quality Standards (NAAQS) for six pollutants
- Two Types of NAAQS: Primary and Secondary
  - ✓ Primary Standards are designed to protect public health
  - ✓ Secondary Standards protect public welfare, including effects of air pollution on vegetation, materials, and visibility

# 7.2 Reference Method and Equivalent Method



Pollutant	Primary Standards		Secondary Standards		Reference Method/Principle	Typical Method/Principle
	Level	Avg. Time	Level	Avg. Time		
Carbon Monoxide	9 ppm (10 mg/m <sup>3</sup> )	8-hour <sup>(1)</sup>	None		Nondispersive infrared photometry	same
	35 ppm (40 mg/m <sup>3</sup> )	1-hour <sup>(1)</sup>				
Lead	1.5 µg/m <sup>3</sup>	Quarterly Average	Same as Primary		High-volume sampling with AA analysis	same
Nitrogen Dioxide	0.053 ppm (100 µg/m <sup>3</sup> )	Annual (Arithmetic Mean)	Same as Primary		Gas-phased chemiluminescence	same
Particulate Matter (PM <sub>10</sub> )	150 µg/m <sup>3</sup>	24-hour <sup>(2)</sup>	Same as Primary		High- or low-volume Sampling	same
Particulate Matter (PM <sub>2.5</sub> )	15.0 µg/m <sup>3</sup>	Annual <sup>(3)</sup> (Arithmetic Mean)	Same as Primary		Low-volume sampling	same
	35 µg/m <sup>3</sup>	24-hour <sup>(4)</sup>	Same as Primary			
Ozone	0.075 ppm (2008)	8-hour <sup>(5)</sup>	Same as Primary		Gas-phased chemiluminescence with ethylene	UV photometry
	0.08 ppm (1997)	8-hour <sup>(6)</sup>	Same as Primary			
	0.12 ppm	1-hour <sup>(7)</sup> (Applies only in limited areas)	Same as Primary			
Sulfur Dioxide	0.03 ppm	Annual (Arithmetic Mean)	0.5 ppm (1300 µg/m <sup>3</sup> )	3-hour <sup>(1)</sup>	Pararosaniline method	UV fluorescence
	0.14 ppm	24-hour <sup>(1)</sup>				

Table 7-1.  
**National Ambient Air Quality Standards (NAAQS)**

## 7.2 Reference Method and Equivalent Method



### Particulate Matter

#### ***PM***<sub>2.5</sub>

- The reference method for PM<sub>2.5</sub> provides for the measurement of the mass concentration of fine particulate matter having an aerodynamic diameter less than or equal to a nominal 2.5 μm in ambient air.
- The method requires sampling over a 24-hour period for purposes of determining whether the primary and secondary NAAQS are met.



## 7.2 Reference Method and Equivalent Method

### Particulate Matter

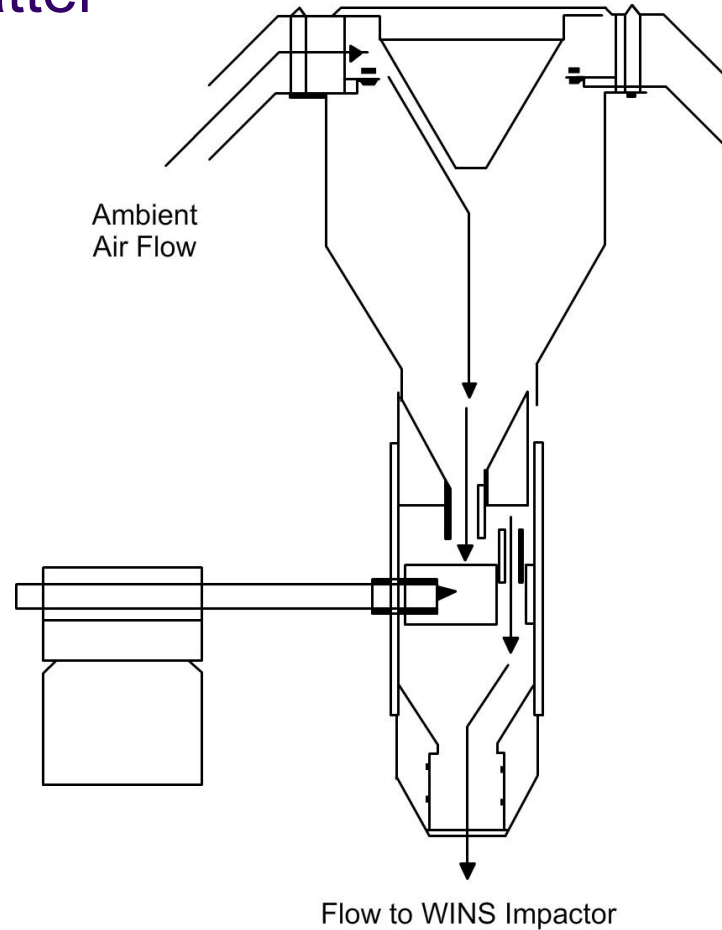

Figure 7-1. Schematic of PM<sub>2.5</sub> sampler utilizing a WINS impactor.

## 7.2 Reference Method and Equivalent Method



### Particulate Matter

#### ***PM<sub>10</sub>***

- The reference method for PM<sub>10</sub> provides for the measurement of the mass concentration of fine particulate matter having an aerodynamic diameter less than or equal to a nominal 10 micrometers in ambient air.
- The method requires sampling over a 24-hour period for purposes of determining whether the primary and secondary NAAQS are met.

# 7.2 Reference Method and Equivalent Method

## Particulate Matter

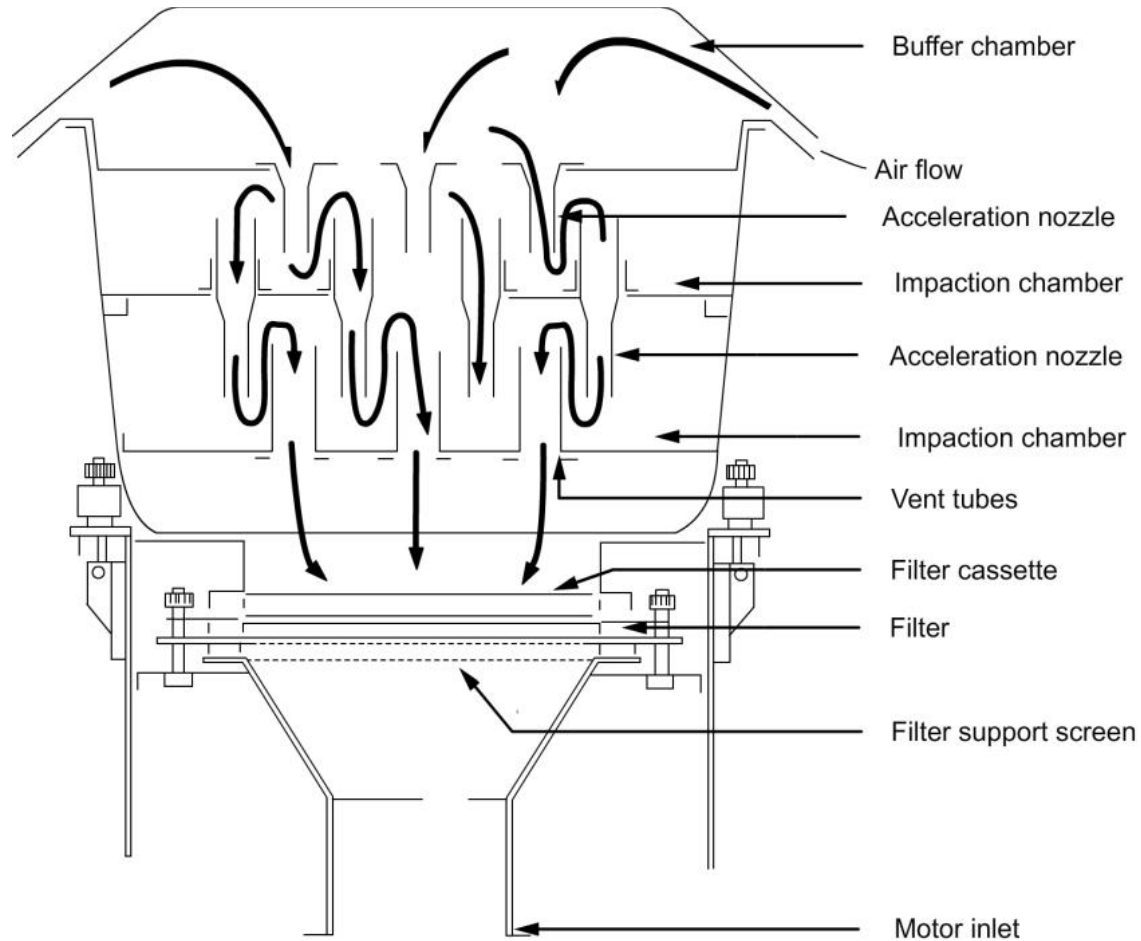

Figure 7-2. Schematic of PM<sub>10</sub> sampler

## 7.2 Reference Method and Equivalent Method



### Particulate Matter - **Ozone**

- The reference measurement principle for the measurement of ozone is the gas-phase chemiluminescence resulting from the reaction of ozone with ethylene.
- Ambient air and ethylene are delivered simultaneously to a mixing zone where the ozone in the air reacts with ethylene to emit light, which is detected by a photomultiplier tube.
- The resulting photocurrent is amplified and is either read directly or displayed on a recorder.
- Ozone monitoring locations now use the equivalent method, which is an ultraviolet method.

# 7.2 Reference Method and Equivalent Method

## Particulate Matter - Ozone

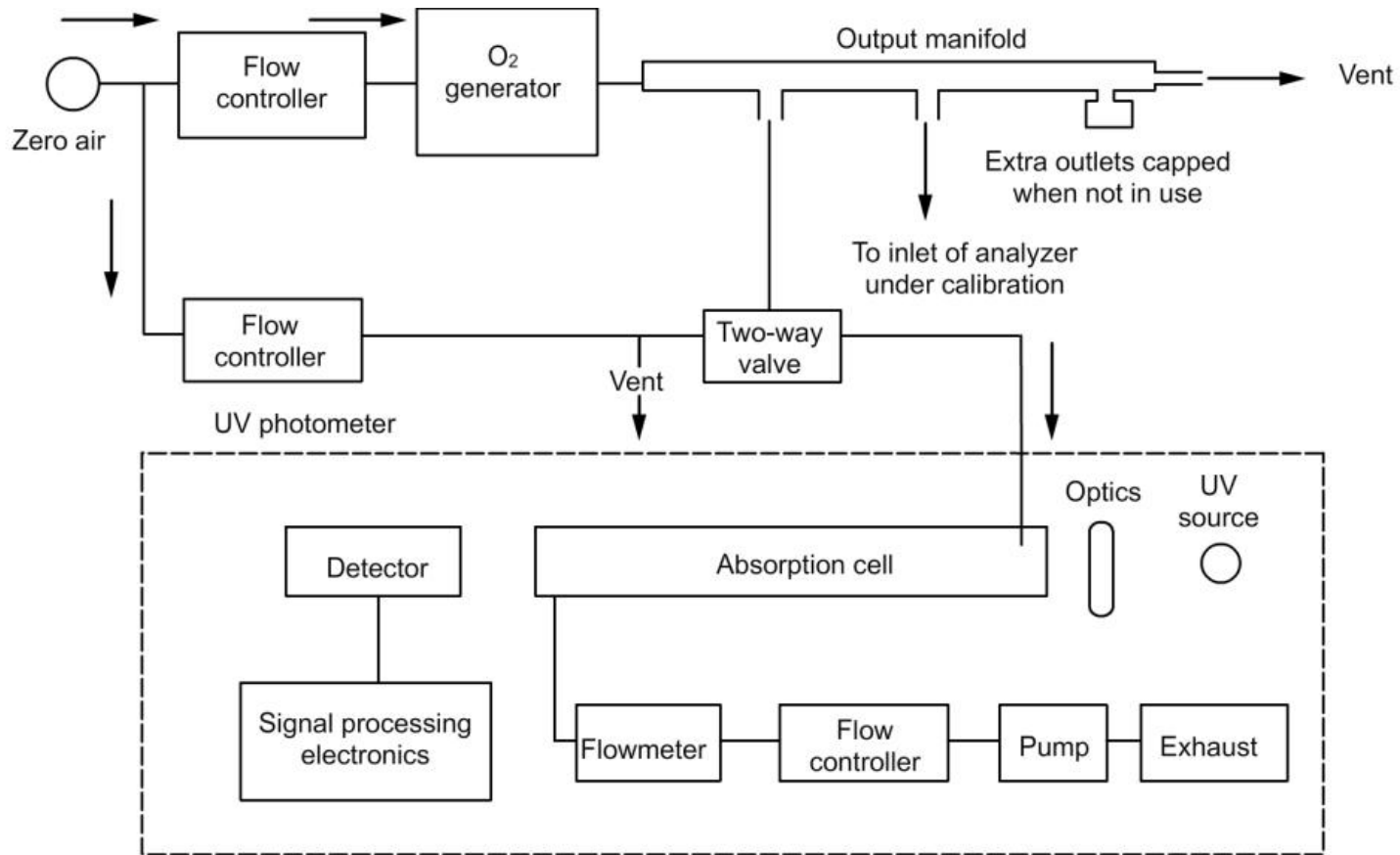

Figure 7-3. Schematic diagram of a typical photometric calibration system.

## 7.2 Reference Method and Equivalent Method



### Particulate Matter – Carbon Monoxide

- The reference measurement principle used to measure ambient levels of carbon monoxide is Nondispersive Infrared (NDIR) photometry.
- The problem areas associated with this method are the broad band absorption of carbon dioxide and water vapor.
- These two compounds' absorption results in an interference.
- The techniques of “negative filtering” or gas filter correlation alleviate these problems.

## 7.2 Reference Method and Equivalent Method



### Particulate Matter – Nitrogen Dioxide

- The reference measurement principle for the determination of nitrogen dioxide is the gas-phase chemiluminescence reaction of nitric oxide with ozone.



- Nitrogen dioxide is measured indirectly by measuring total oxides of nitrogen and electronically subtracting the nitric oxide concentration ( $\text{NO}$ ), yielding a nitrogen dioxide determination ( $\text{NO}_2$ ).

## 7.2 Reference Method and Equivalent Method



### Particulate Matter – Nitrogen Dioxide

- A measure of the total oxides of nitrogen is obtained by passing the sample across a catalytic converter, which reduces nitrogen dioxide to nitric oxide.



- The calibration of the  $\text{NO}$  and  $\text{NO}_x$  channels of the instrument is accomplished by diluting a pressurized tank of  $\text{NO}$ .
- The calibration of the  $\text{NO}_2$  channel is accomplished with a permeation device or the gas-phase titration of an  $\text{NO}$  standard gas with ozone. The gas-phase titration involves the following reaction.





## 7.2 Reference Method and Equivalent Method



### Particulate Matter – Sulfur Dioxide

- The reference method for the measurement of dioxide in ambient air is a manual wet-chemical method – the pararosaniline method.
- Sulfur dioxide is bubbled through a solution of potassium tetrachloromercurate (TCM) which forms a monochlorosulfonatomercurate complex.
- This complex forms an intensely colored solution upon addition of pararosaniline dye and formaldehyde. The concentration of sulfur dioxide can be determined spectrophotometrically by measuring the absorbance of the colored solution.

## 7.2 Reference Method and Equivalent Method



### Particulate Matter – Sulfur Dioxide

The potential problems associated with interferences are minimized by the procedures listed in Table 7-2. Parasaniline Interferences below:

Interference	Corrective procedure
Ozone	Time delay
Heavy metals	Addition of EDTA and phosphoric acid
Oxides of nitrogen	Addition of sulfamic acid

Table 7-2. Parasaniline interferences.

## 7.2 Reference Method and Equivalent Method

### Particulate Matter – Sulfur Dioxide

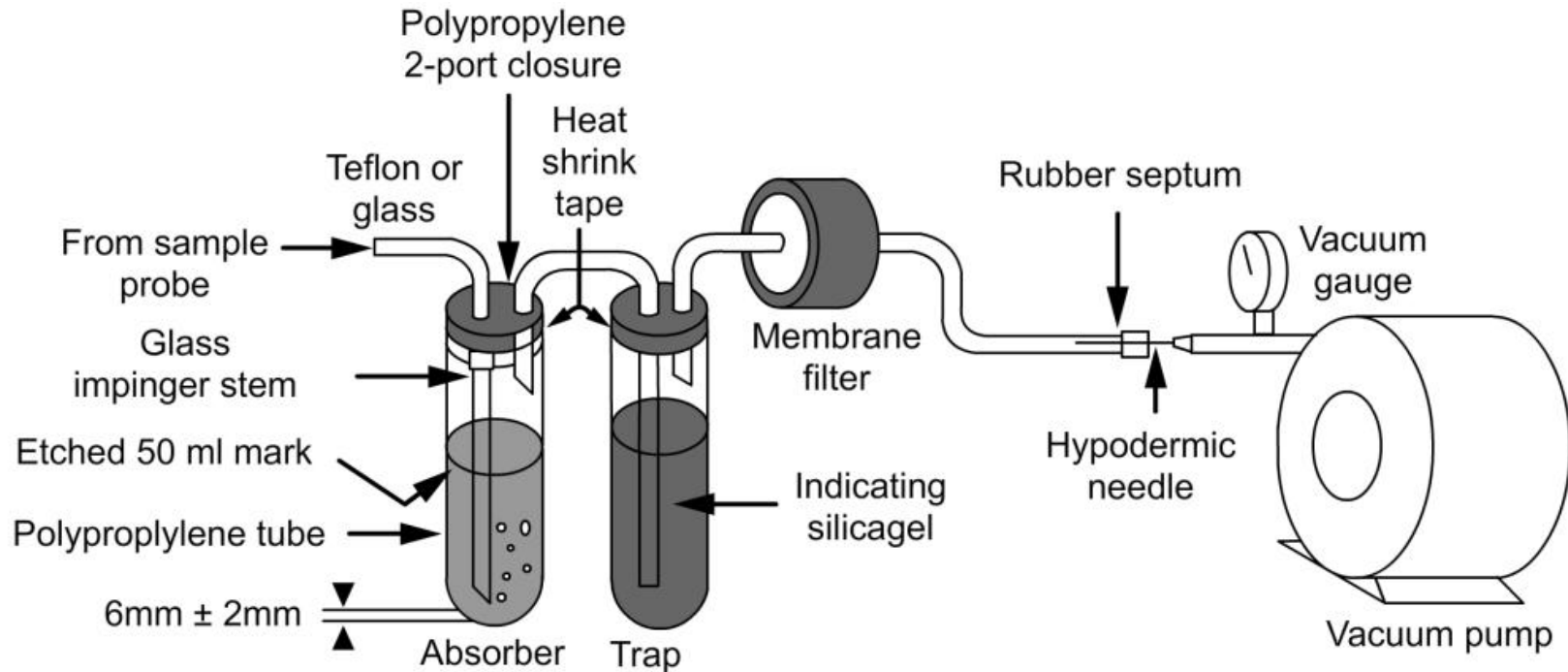

Figure 7-4. SO<sub>2</sub> sampling train for 24-hour sampling.

## 7.2 Reference Method and Equivalent Method



### Particulate Matter - Lead

- The reference method for lead consists of measuring the lead content of particulate matter collected by the total suspended particulate reference method's high-volume sampling procedure.
- In the high-volume method, air is drawn through a filter composed of glass fibers or other relatively inert, nonhygroscopic material, and the amount of particulate matter collected is determined gravimetrically.
- The problems with this method are the nonuniformity of sampling flow rate, artifact formation of sulfates and nitrates, loss of volatiles, filter handling errors, hygroscopic particulate matter, nonsampled particulate matter, timing errors, recirculation of sampler exhaust, and the wind direction sensitivity of the sampler.

# Chapter 7

## Standard Methods for Criteria Pollutants



# Questions?

# Chapter 8

## Introduction to Ambient Air Sampling for Air Toxics



---

## APTI 435: Atmospheric Sampling Course



# Terminal Learning Objectives



- At the end of this chapter, the student will be able to describe ambient air sampling for air toxics.

# Enabling Learning Objectives



- 8.1-Define *toxic air pollutants*.
- 8.2-Describe risk assessment and risk characterization.
- 8.3-Describe the air toxics methods for the air toxics monitoring program.



# Introduction



## What are Toxic Air Pollutants?

Poisonous substances in the air that come from natural or manmade sources and can harm the environment or your health.

# Introduction

## Clean Air Act of 1990

Breakdown of HAP's by class

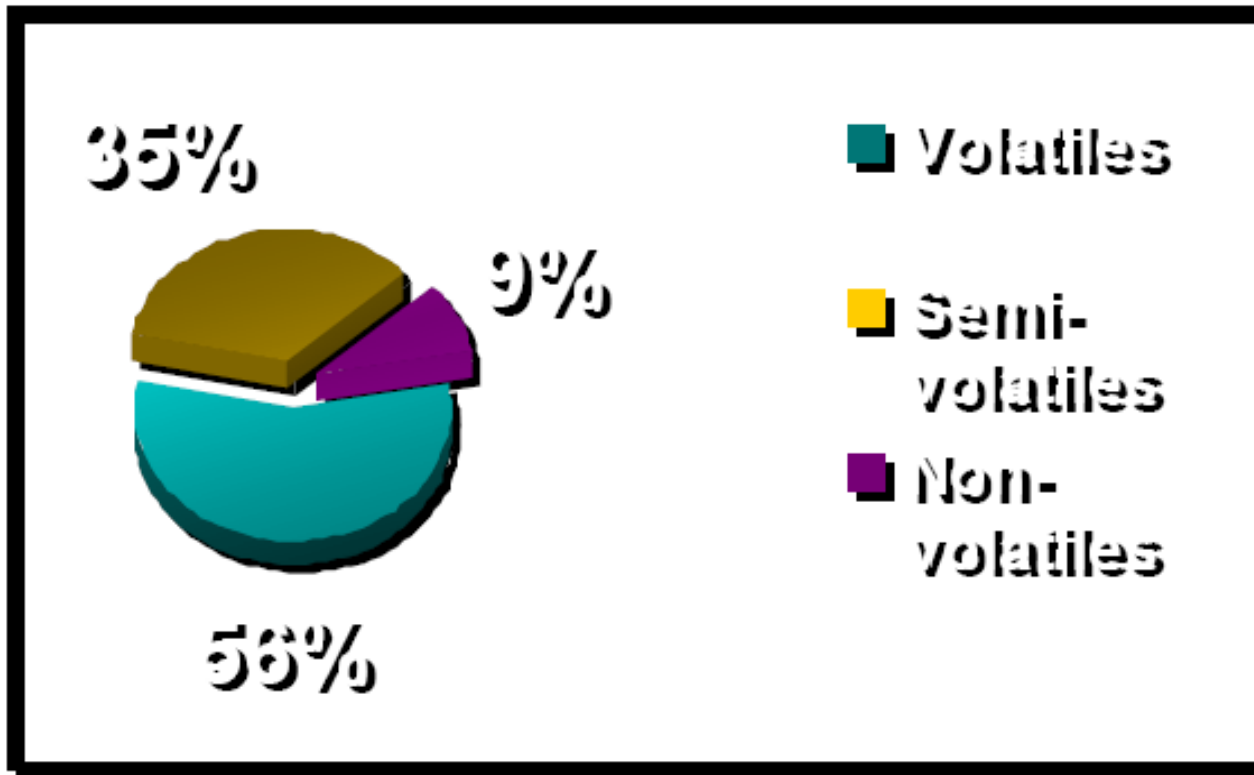

# Introduction



## Timeline for Air Toxics Monitoring

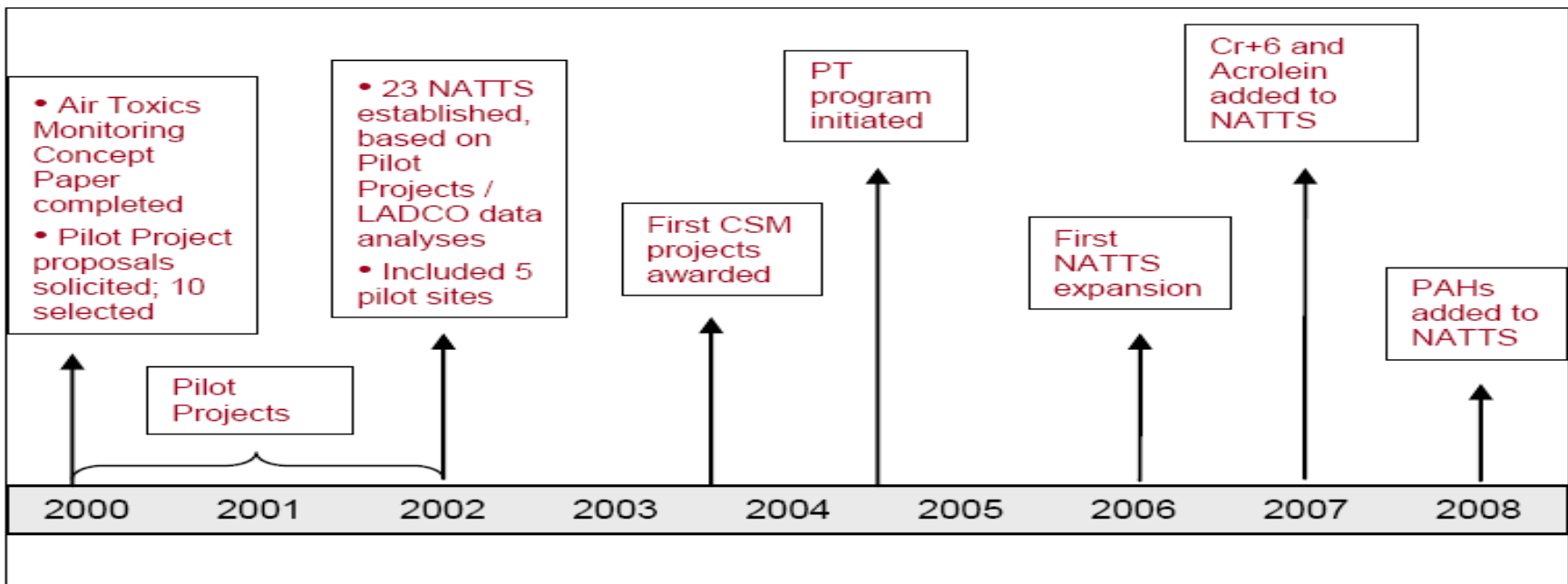
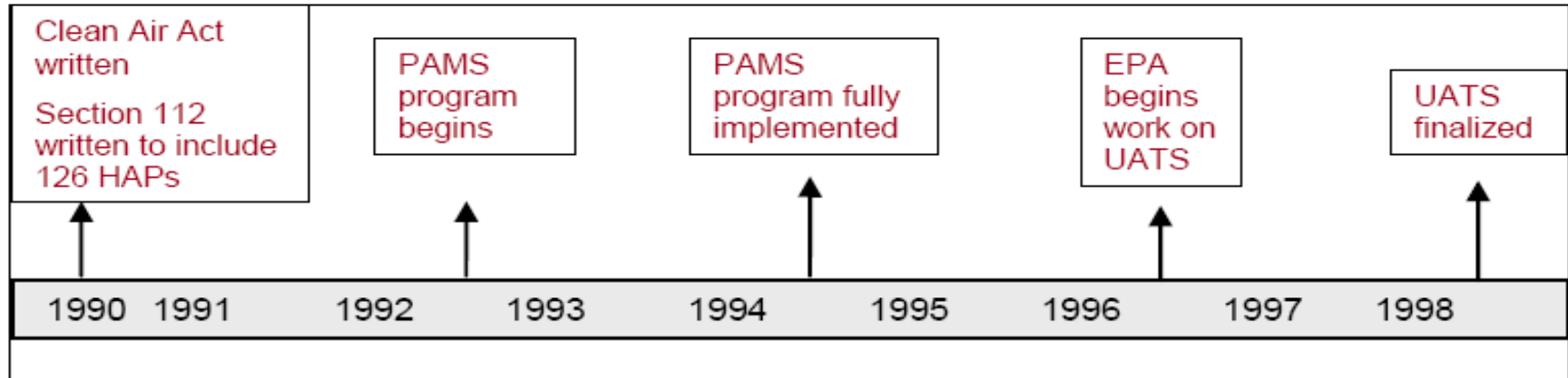

# What is Risk?

$$\text{RISK} = f [(\text{Measure of Exposure}) (\text{Measure of Toxicity})]$$

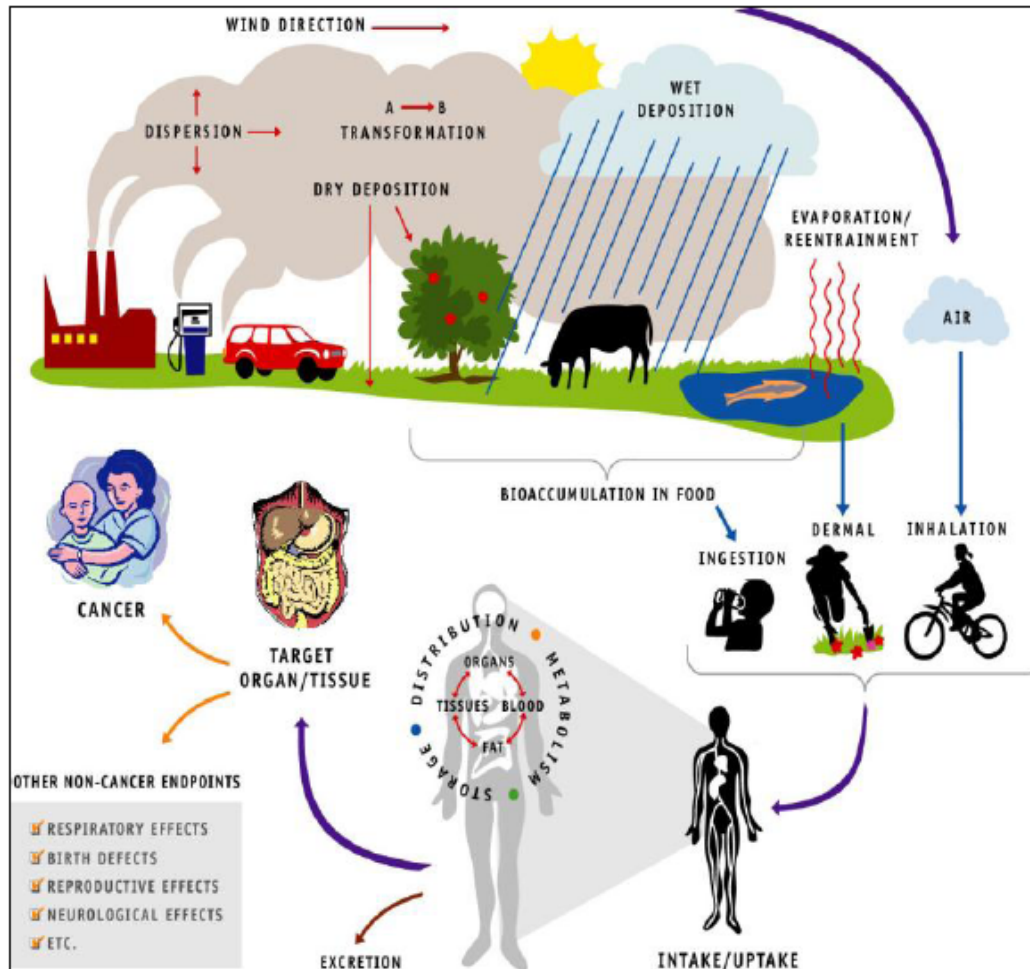

Various Pathways of Exposure to HAPs

# What is Risk?

## What is a Risk Assessment?



# What is Risk?



- Hazard Identification
- Weight of Evidence for Health Problems of Concern
- Exposure Assessment
- Dose-Response Assessment
- Dose-Response Relationship
- Risk Characterization

Maximum  
Lifetime  
Exposure

**X**

Dose-Response  
Relationship

**=**

Maximum  
Individual  
Lifetime Risk

# Introduction to Air Toxics Methods



## Monitoring Program Goal and Objectives

### Goal

- To support reduction of public exposure to HAPs

### Objectives

- Trends
- Exposure Assessments
- Air Quality Model Evaluation

### Sub-objectives

- Program Accountability
- Problem Identification
- Science Support

# Introduction to Air Toxics Methods



## Classification of Air Toxics Methods

Organic                      Inorganic

- <http://www.epa.gov/ttn/amtic/inorg.html>
- <http://www.epa.gov/ttn/amtic/airtox.html>

United States  
Environmental Protection  
Agency

Center for Environmental  
Research Information

EPAN05R-68010b  
January 1999

Research and Development

EPA **Compendium of Methods for  
the Determination of Toxic  
Organic Compounds in  
Ambient Air - Second Edition**

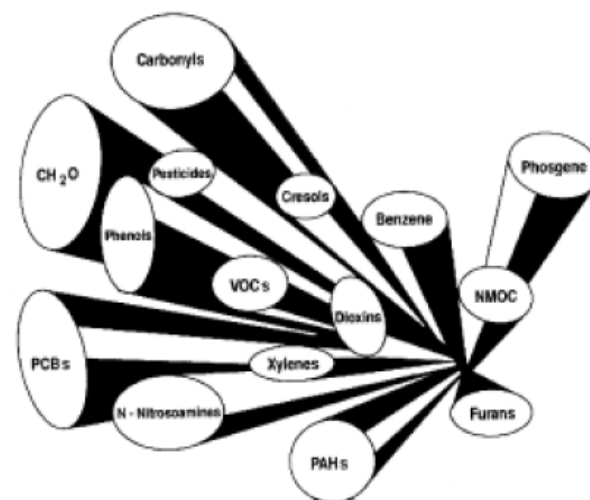



# Introduction to Air Toxics Methods



## Description of the Methods

Method No.	Compounds
TO-1	VOCs
TO-2	VOCs
TO-3	VOCs
TO-4A	Pesticides and polychlorinated biphenyls
TO-5	Aldehyde and ketones
TO-6	Phosgene
TO-7	Amines
TO-8	Phenols
TO-9A	Dioxin/furans
TO-10A	Pesticides and polychlorinated biphenyls
TO-11A	Aldehydes and ketones
TO-12	Non-methane organic compounds
TO-13A	Polycyclic aromatic hydrocarbons
TO-14A	Nonpolar VOCs by flame ionization
TO-15A	Polar VOCs by mass spectroscopy
TO-16	VOCs by open path spectroscopy
TO-17	VOCs collection by diffusion tubes

← Toxic Organic Methods

Toxic Inorganic Methods →

Method No.	Compounds/Technique
IO-1	Sampling of particle matter 10 microns or less
IO-2	Sampling of total suspended particles
IO-3	Chemical speciation of particle matter
IO-4	Determination of reactive acidic and basic gases
IO-5	Sampling and analysis of mercury

# Introduction to Air Toxics Methods



## Compendium Method TO-11A

Formaldehyde and other Carbonyl Compounds (Aldehydes and Ketones)



Examples of DNPH Cartridges

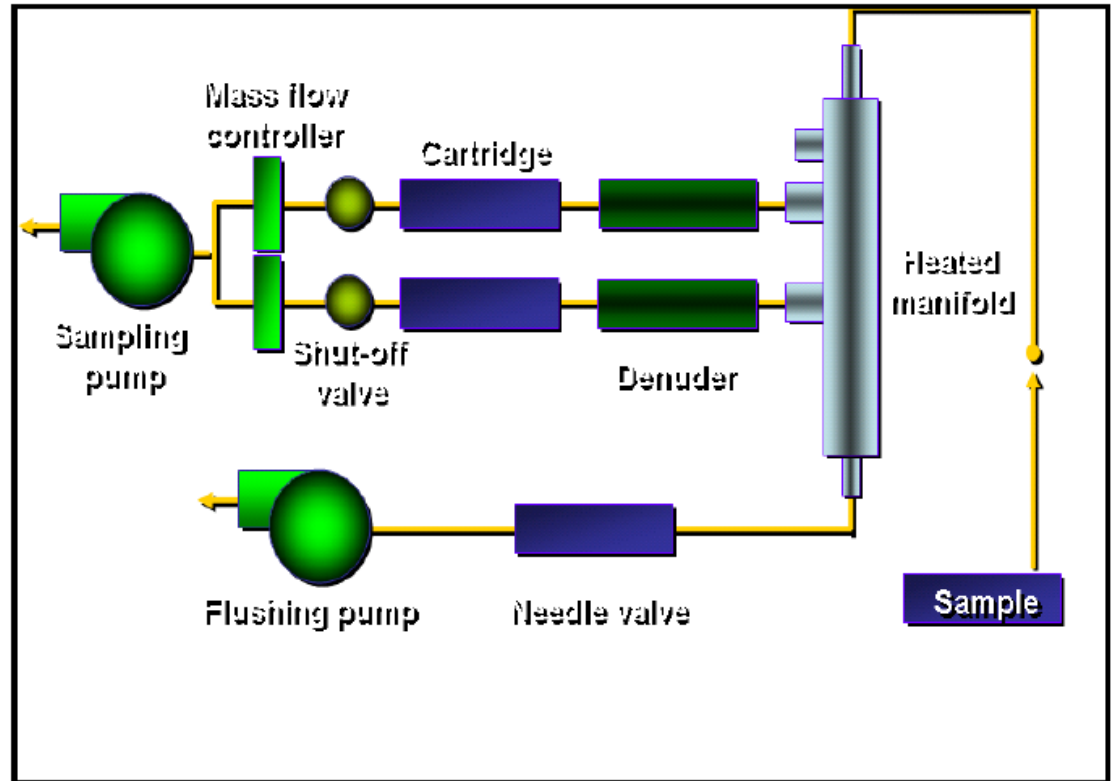
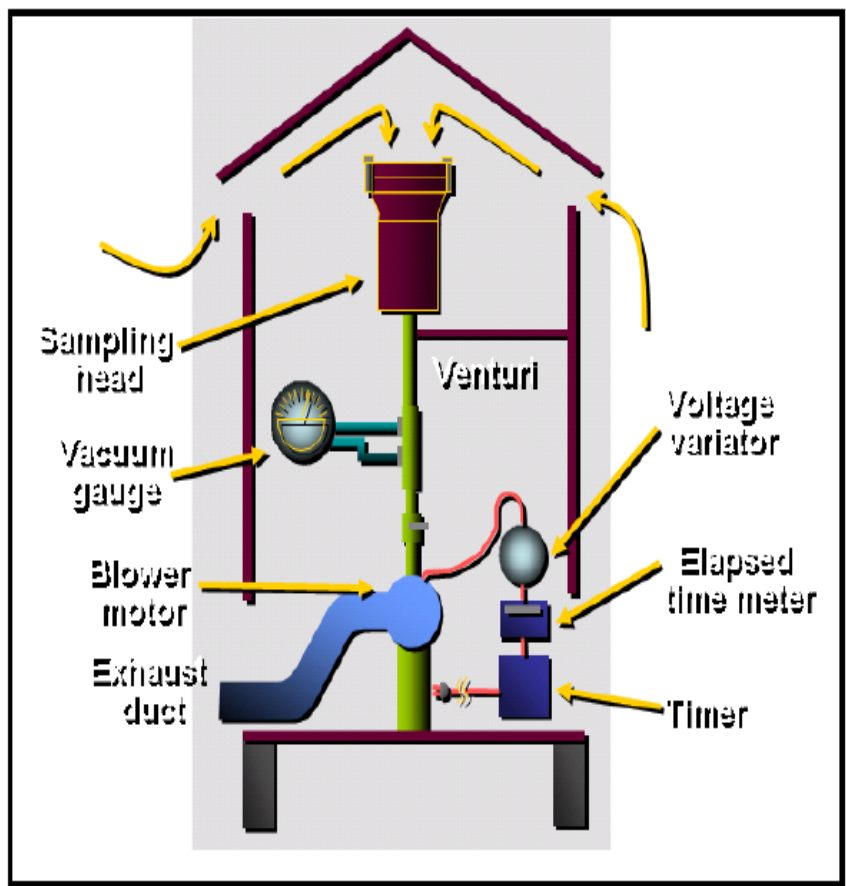

Diagram of a TO-11A sampler

# Introduction to Air Toxics Methods



## Compendium Method TO-13A SOVC's (Naphthalene, Anthracene, Benzoapyrene...)



Block Diagram of a PUF sampler

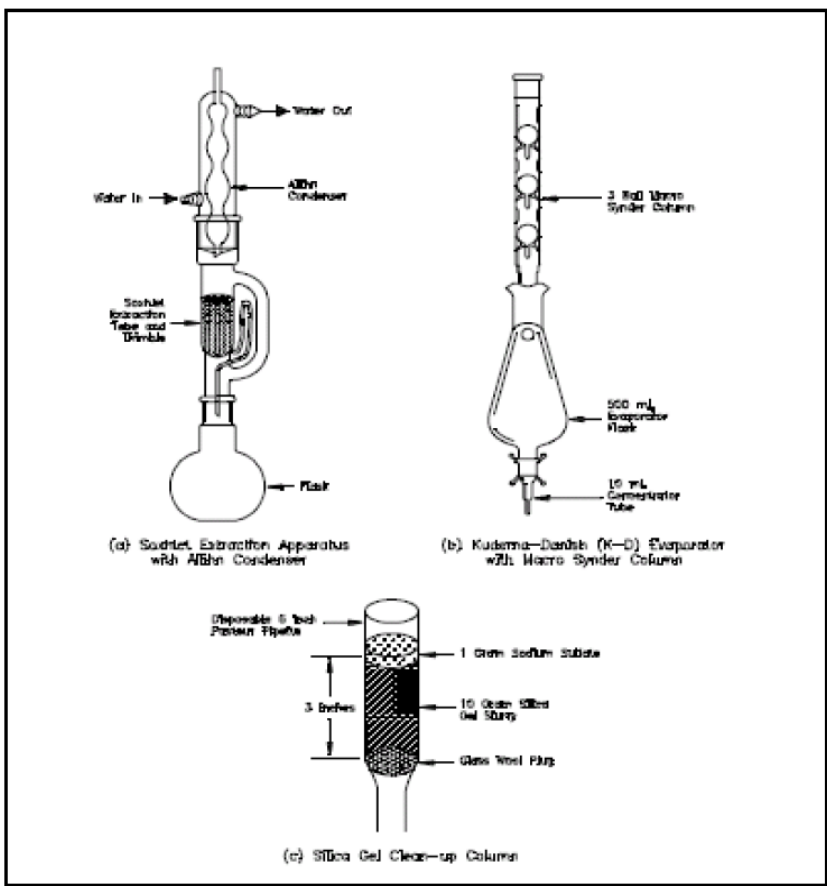

Soxlet, K-D, and PUF/XAD-2<sup>®</sup> sandwich

# Introduction to Air Toxics Methods



Compendium Method TO-15A

VOC's (Benzene, Vinyl Chloride, Carbon Tetrachloride...)



Passivated Canister

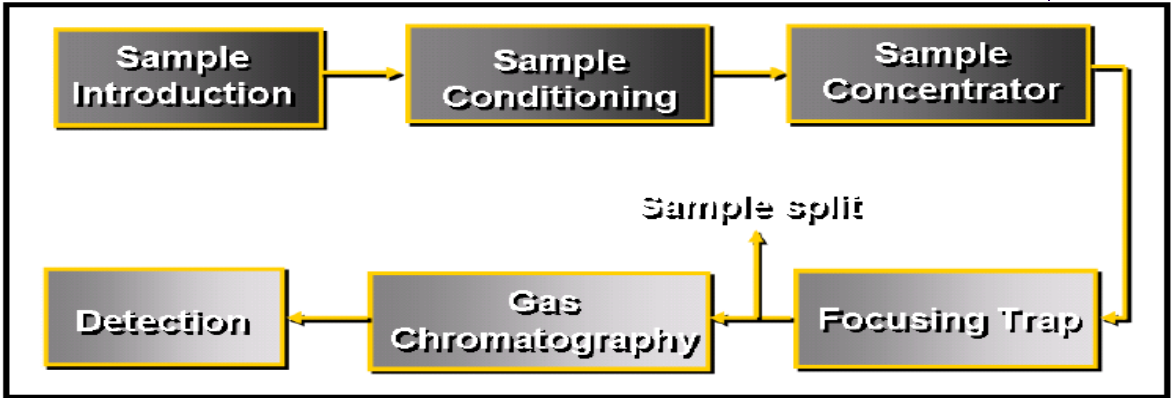

Flow Diagram of the TO-15A method

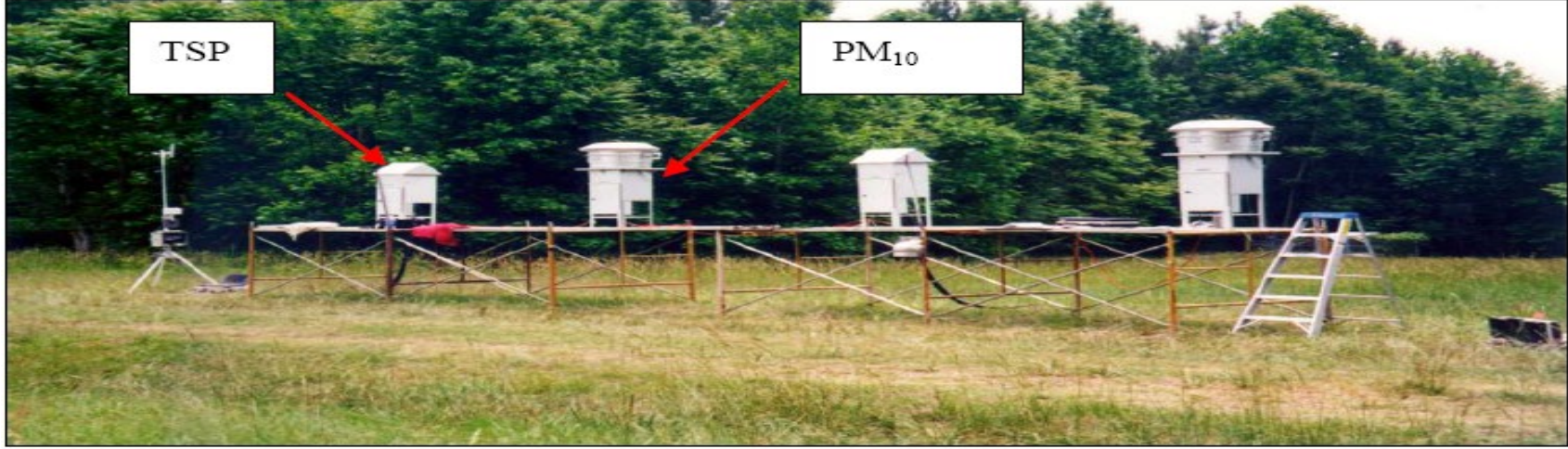

High-volume TSP and PM<sub>10</sub> Samplers

# Chapter 8

## Introduction to Ambient Air Sampling for Air Toxics



# Questions?